

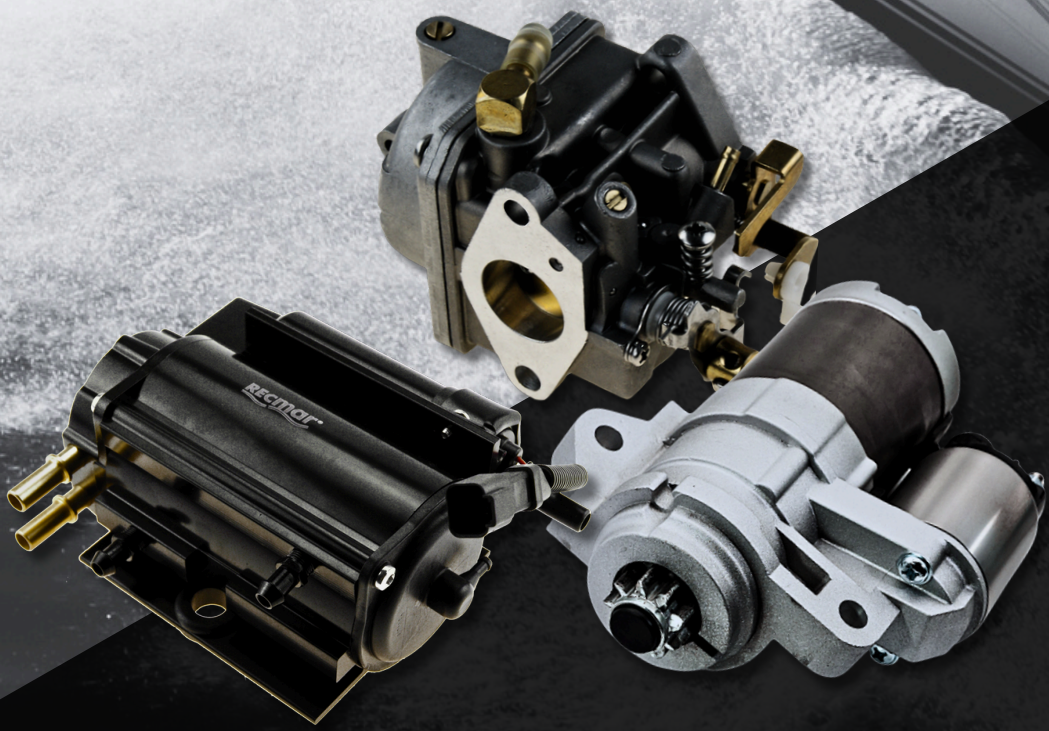















**RECMAR®**





HIGH QUALITY MARINE PARTS











# FOR JOHNSON EVINRUDE



## ICONOS ICONS

	Medida	Measures
	Peso	Weight
	Material	Material
	Flujo Velocidad	Flow Speed
	Presión	Pressure
	Temperatura	Temperature
	Electricidad	Power
	Unidades x bolsa	Units x bag
	Unidades x skinpack	Units x skinpack
	Tornillo	Screw
	Tubo Manguera	Tube
	Rosca	Thread
	Rosca Macho	Male Thread
	Entrada	IN
	Salida	OUT

	Filtro	Filter
	Elemento filtro	Filter Element
	Junta	Gasket
	Llave	Key
	Posiciones llave	Key positions
	Mando	Control
	Pins	Pins
	Cables Terminales	Terminals
	Cable	Cable
	Piston	Piston
	Aros de piston	Piston ring
	Cojinete	Bearing
	Bulón	Pin
	Biela	Connecting rod
	Clip	Clip

	Impulsor	Impeller
	Dientes	Tooth
	Aguja carburador	Carburetor needle
	Flotador carburador	Carburetor float
	Abrazadera	Clamp
	Volante motor	Flywheel
	Estrias	Spline
	Polea	Pulley
	Solenide Relé	Solenoid Relay
	Motor	Motor

## IMPORTANTE

LOS PRODUCTOS QUE APARECEN EN NUESTROS CATALOGOS SON VÁLIDOS Y COMPATIBLES CON LOS MOTORES Y TRANSMISIONES DE LAS MARCAS ORIGINALES QUE APARECEN EN CADA SECCIÓN. ESTA INFORMACIÓN APARECE CON LA REFERENCIA EN EL MOMENTO DE CONFIRMAR EL PEDIDO POR NUESTRA WEB.

LA IMÁGENES AQUÍ CONTENIDAS PUEDEN NO CORRESPONDER CON TOTAL PRECISIÓN AL PRODUCTO SUMINISTRADO. RECAMBIOS MARINOS, S.L.U. SE RESERVA EL DERECHO DE ANULAR O CAMBIAR PRODUCTOS SIN PREVIO AVISO.

## IMPORTANT

THE PRODUCTS THAT APPEAR IN OUR CATALOGS ARE VALID AND COMPATIBLE WITH THE MOTORS AND TRANSMISSIONS OF THE ORIGINAL BRANDS THAT APPEAR IN EACH SECTION. THIS INFORMATION APPEARS WITH THE REFERENCE AT THE TIME OF CONFIRMING THE ORDER BY OUR WEB.

IMAGES CONTAINED HERE MAY NOT CORRESPOND WITH TOTAL ACCURACY TO THE PRODUCT SUPPLIED. RECAMBIOS MARINOS, S.L.U. RESERVES THE RIGHT TO CANCEL OR CHANGE PRODUCTS WITHOUT PRIOR NOTICE.

<b>FUEL &amp; FILTRATION SYSTEM</b>	50	<b>SEALS</b>	78	<b>OIL SEALS</b>	102
ACCELERATOR	56	GEARCASE SEAL APPLICATION	79	O-RING DRAIN CAP	102
ACCELERATOR CAM	57	O-RING	80		
RETAINER	57	SEAL KIT	80	<b>UNIT DRIVES &amp; COMPONENTS</b>	103
THROTTLE CABLE	56	<b>THERMOSTAT</b>	75	<b>GEARCASE ASSY</b>	103
<b>CARBURATOR</b>	55	COVER	76	<b>GEARCASE PARTS - 4 STROKES</b>	105
CARBURATOR - KITS	56	GASKETS	76	J4, J5, J6	105
GASKETS	56	GASKETS, EXHAUST INNER COVER	76	J10, J15	106
FLOATS	55	NIPL	76	J25	108
FULL CARBURATOR	55	PLUG WATER FLUSH	77	J25, J30, J40, J50	110
NEEDLE VALVE, KIT	55	RETAINER	76	DF40, DF50	112
<b>FUEL FILTERS AND ELEMENTS</b>	50	THERMOSTAT - GUIDE	77	J/BJ 60, 70	114
HIGH PRESSURE	51	<b>WATER PUMP</b>	81	J/BJ 90, 115, 140	115
IN-LINE FUEL FILTER	50	CLIP	82	J/BJ 200, 225, 250	116
LOW PRESSURE	51	DIAPHRAGM	84	<b>GEARCASE PARTS - 2 STROKES</b>	117
<b>FUEL PUMP</b>	52	DRAIN SCREW	87	4, 4.5, 5, 6, 7.5, 8	117
FUEL PUMP - ELECTRIC	53	HOUSING	81	9.9, 15	118
FUEL PUMP - GASKETS	53	IMPELLER PLATE	83	25, 28	119
FUEL PUMP - KITS	54	SLINGER	82	20, 35	120
FUEL PUMP - MECHANICAL	52	SCREW	86	40, 50	121
DIAPHRAGM SET	54	TUBE GROMMET	83	40, 60, 75	122
VST GASKETS	54	WATER PUMP - GASKET	84	V4/V6	124
<b>FUEL TANK CONNECTORS</b>	50	WATER PUMP - GASKET BASE	81	V4/V6 0	125
INJECTORS	55	WATER PUMP - GUIDE	87	V4/V6 M	126
OIL FILTER	52	WATER PUMP - O-RING	82	V6	127
		WATER PUMP - PLATE	84	<b>STERN DRIVE PARTS</b>	128
		WATER PUMP - SERVICE KIT	85	BUSH SWIVEL	131
<b>ELECTRIC SYSTEM</b>	57	<b>ENGINE PARTS</b>	91	CLUTCH DOGS	129
BATTERY CABLES	59	<b>CRANKSHAFT</b>	94	CLUTCH DOGS - PIN	129
CDI & POWER PACK	66	BEARING GUIDE	96	CLUTCH DOGS - ROD PUSH	129
COILS	58	CONNECTING ROD	94	CLUTCH DOGS - SPRING	129
CUT OFF SWITCHES	63	CONNECTING ROD BEARING	95	DIABOLO	132
DISTRIBUTOR	60	CRANKSHAFT GUIDE	94	DIABOLO - BEARING	132
CONDENSER	60	LOWER BEARING	95	DIABOLO - O-RING	132
IGNITION STARTER SWITCH	63	OIL SEALS	94	DRAIN, SCREW AND GASKETS	132
REGULATOR AND RECTIFIERS	64	UPPER BEARING	95	DRAIN WATER TUBE	131
SENSORS	57	<b>ENGINE PARTS - 4 STROKES</b>	91	INITIATIVE GEAR	128
SENSOR CMP, IAC, MAT/MAP	57	J/BJ 40, 50 HP	91	INITIATIVE GEAR - SHIM	128
SOLENOID RELAY	64	<b>ENGINE GASKETS - 4 STROKES</b>	92	INITIATIVE GEAR - WASHER	128
SPARK PLUG WIRE SET	59	CYLINDER GASKET	93	LOWER DRIVE SHAFT	130
STARTERS	60	CYLINDER HEAD GASKET	92	LOWER HOUSING BEARING GUIDE	130
REWIND SPRING	62	CYLINDER HEAD GASKET - KIT	92	OIL PUMP - BEARING	131
STARTER PAWL	63	COVER SELECTOR GASKET	93	POSITIVE GEAR	128
STARTER PAWL SPRING	62	GASKET, CYLINDER COVER	92	PROP SHAFT	130
<b>STARTOR</b>	67	GASKET, PRESSURE VALVE	93	REVERSE GEAR	128
GUIDE - POWER PACK, STARTOR, TRIGGER	68	GASKET, THROTTLE BODY	94	SHIFT, BELOW	131
<b>TRIM, TILT &amp; POWER TRIM</b>	69	GASKET, UPPER SEAL	93	SHIFT, O-RING	131
COMPLETE TRIM ASSEMBLY	69	THERMOSTAT COVER	93	TURNBUCKLE, CUTCH ROD	131
PLUG PISTON TRIM	70	<b>ENGINE GASKETS - 2 STROKES</b>	97	UPPER DRIVE SHAFT	130
RELAY	70	BYPASS COVER GASKET	99	UPPER DRIVE SHAFT BEARING	130
TRIM SENSOR	70	CYLINDER GASKET	99	WASHER	131
WIRING HARNESS	70	CYLINDER HEAD GASKET	97	WATER PUMP BEARING	132
		CYLINDER HEAD GASKET - GUIDE	99	<b>GEARCASE SEAL KIT</b>	133
		CYLINDER HEAD GASKET - KIT	98	ELECTRIC / HYDRAULIC SHIFT	133
<b>STEERING SYSTEM</b>	71	<b>GUIDE TIMING BELT</b>	99	MECHANICAL SHIFT	133
<b>ENGINE CONTROLS</b>	71	<b>PISTONS</b>	97	OIL SEALS	133
CONSOLE CONTROL	72	<b>EXHAUST &amp; INTAKE SYSTEM</b>	100	O-RING GUIDE	134
SIDE CONTROL	71	<b>EXHAUST SYSTEM</b>	100	<b>TOOLS</b>	134
<b>SWITCHES &amp; CABLES</b>	73	EXHAUST SYSTEM - INTERMEDIATE HOUSING	100	FLYWHEEL PULLER	134
CONTROL SWITCH	74	EXHAUST SYSTEM - GASKETS	100		
HARNESS	73	OIL PAN GASKET	100	<b>POPULSION SYSTEM</b>	135
HARNESS EXTENSION	74	SEALS - HOUSING EXHAUST	100	<b>PROP PARTS</b>	135
TRIM SWITCH	73	<b>INTAKE SYSTEM</b>	101	WATER TUBE BRACKET	135
<b>COOLING SYSTEM</b>	75	AIR SILENCER GALLERY	101	KIT	135
<b>ANODE</b>	88	CARBURETOR TO INTAKE GASKETS	101	PIN	135
GASKET, ANODE COVER	90	GASKET, COLLECTOR	101	PROPELLER - WASHER	135
KITS	90	POWERHEAD TRANSFER GASKET	101	PROPELLER - PIN	135
O-RING	90	POWERHEAD WATER COVER GASKETS	101	PROPELLER NUT	135
SS SCREW	90	REED PLATE GASKETS	101	<b>OEM --&gt; REF</b>	136
<b>IMPELLER GUIDE</b>	77			<b>REF --&gt; OEM</b>	139
KEY	78				

# JOHNSON EVINRUDE

ES

<b>SISTEMA DE ALIMENTACIÓN Y FILTRACIÓN</b>	50	<b>BOMBA DE AGUA</b>	81	<b>SISTEMA DE ESCAPE</b>	100
<b>ACCELERADOR</b>	56	CASQUILLO INOX	82	JUNTAS	100
CABLES	56	CIRCLIP	84	RETENES CUERPO DE ESCAPE	100
LEVA ACCELERADOR	57	CUERPO	81	<b>UNIDADES DE TRANSMISIÓN</b>	103
RETENEDOR	57	DIAFRAGMA	84	<b>COLA COMPLETA</b>	103
<b>BOMBA DE COMBUSTIBLE</b>	52	GRUESO TUBO	83	<b>DESPIECE COLAS 4 TIEMPOS</b>	105
BOMBA DE COMBUSTIBLE ELÉCTRICA	53	GUÍA BOMBAS DE AGUA	87	J4, J5, J6	105
BOMBA DE COMBUSTIBLE MECÁNICA	53	JUNTAS BASE	81	J10, J15	106
JUNTAS	53	JUNTAS BOMBA	84	J25	108
JUNTAS VST	54	JUNTAS TÓRICA	82	J25, J30, J40, J50	110
KITS	54	KIT DE REPARACIÓN	85	DF40, DF50	112
MEMBRANAS	54	PLACA IMPULSOR	83	J/BJ 60, 70	114
<b>CARBURADOR</b>	55	PLACA DE LA BOMBA	82	J/BJ 90, 115, 140	115
BOYAS	55	TORNILLO DRENAJE	87	J/BJ 200, 225, 250	116
CARBURADOR COMPLETO	55	TORNILLO DE LA BOMBA	86	<b>DESPIECE COLAS 2 TIEMPOS</b>	117
CARBURADOR - KITS	56	<b>GUÍA DE IMPULSORES</b>	77	4, 4.5, 5, 6, 7.5, 8	117
JUNTAS	56	CHAVETA	78	9.9, 15	118
KIT AGUJAS	55	<b>RETENES</b>	78	25, 28	119
<b>CONECTORES DE TANQUE</b>	50	AROS TÓRICOS	80	20, 35	120
<b>FILTRO DE ACEITE</b>	52	GUÍA DE RETENES	79	40, 50	121
JUNTA TAPÓN DEL CARTER	52	KITS RETENES	80	40, 60, 75	122
<b>FILTRO DE COMBUSTIBLE Y ELEMENTOS</b>	50	RETENES	78	V4/V6	124
FILTRO COMBUSTIBLE - MONTAJE LÍNEA	50	<b>TERMOSTATO</b>	75	V4/V6 0	125
FILTRO COMBUSTIBLE ALTA PRESIÓN	51	CUBIERTA	76	V4/V6 M	126
FILTRO COMBUSTIBLE BAJA PRESIÓN	51	GUÍA	77	V6	127
<b>INYECTORES</b>	55	JUNTAS	76	<b>HERRAMIENTAS DE COLA</b>	134
<b>SISTEMA ELÉCTRICO</b>	57	JUNTAS TAPA DE REFRIGERACIÓN	76	<b>KIT REPARACIÓN COLA</b>	133
<b>BOBINAS</b>	58	KIT TAPÓN	77	CAMBIO ELÉCTRICO	133
BUJÍAS, CABLES	59	NIPLE	76	CAMBIO MECÁNICO	133
CABLES DE BATERÍA	59	RETÉN	76	GUÍA DE TÓRICAS	134
CDI Y CAJAS NEGRAS	66	<b>PARTES DEL MOTOR</b>	91	RETENES	133
DESCONECTORES DE SEGURIDAD	63	<b>CIGÜENAL</b>	94	<b>PIEZAS TRANSMISIÓN</b>	128
DISTRIBUIDOR	60	BIELAS	94	ARANDELA	131
CONDENSADOR	60	COJINETES CABEZA DE BIELA	95	CASQUILLO BASCULANTE	131
<b>LLAVES DE ARRANQUE</b>	63	COJINETES INFERIORES	95	COJINETE BOMBA DE ACEITE	131
<b>MOTORES DE ARRANQUE</b>	60	COJINETES PIE DE BIELA	95	COJINETE BOMBA DE AGUA	132
MUELLE SEGURO ARRANQUE	62	COJINETES SUPERIORES	95	DIÁBOLO	132
MUELLE DE ARRANQUE	62	GUÍA COJINETES	96	DIÁBOLO - COJINETE	132
UNAS ARANQUE MANUAL	63	GUÍA RETENES	94	DIÁBOLO - TÓRICA	132
<b>REGULADORES Y RECTIFICADORES</b>	64	RETENES	94	EJE HÉLICE	130
<b>SENSORES</b>	57	<b>DESPIECE MOTOR DE 4 TIEMPOS</b>	91	EJE TRANSMISIÓN INFERIOR - COJINETES	130
SENSOR CMP, IAC, IAT, MAT/MAP	57	J/BJ 40, 50 HP	91	EJE TRANSMISIÓN SUPERIOR	130
<b>SOLENOIDE RELE</b>	64	<b>CORREAS DE DISTRIBUCIÓN</b>	99	EJE TRANSMISIÓN SUPERIOR - COJINETES	130
<b>STARTOR</b>	67	<b>JUNTAS DE MOTOR 4 TIEMPOS</b>	92	GUÍA COJINETES DE COLA	130
GUÍA CAJA NEGRA, STARTOR, TRIGGER	68	BASE DE MOTOR	93	PIN	129
<b>TRIM, TILT &amp; POWER TRIM</b>	69	CULATA - JUNTAS Y KITS	92	PINÓN ATAQUE - ARANDELA	129
INSTALACION ELECTRICA	70	JUNTAS CUERPO DE MARIPOSA	94	PINÓN ATAQUE - GRUESO	128
TAPÓN PISTON	70	JUNTAS RETÉN SUPERIOR	93	PINONES ATAQUE	128
TRIM COMPLETO	69	JUNTAS TAPA DE TERMOSTATO	93	PINONES MARCHA ATRÁS	128
TRIM - SENSOR	70	JUNTAS VALVULA DE PRESION	93	PINONES MARCHA AVANTE	128
TRIM - RELE	70	TAPA DE BALANCINES	92	SELECTOR	129
<b>SISTEMA DE GOBIERNO</b>	71	TAPA DE SELECTOR	93	SELECTOR - MUELLE	129
<b>INTERRUPTORES Y CABLES</b>	73	<b>JUNTAS DE MOTOR 2 TIEMPOS</b>	97	SELECTOR - PASADOR	129
ARNES	73	BASE DE MOTOR	98	SELECTOR - VARILLA	129
EXTENSION ARNES	74	CULATA	97	TORNILLO Y JUNTAS DRENAJE	132
INTERRUPTOR MANDO	74	CULATA - GUÍA	98	TUBO DRENAJE	131
INTERRUPTOR TRIM	73	CULATA - KIT	98	VARILLA DE CAMBIO - ARO TÓRICO	131
<b>MANDOS DE CONTROL</b>	71	JUNTA TAPA BYPASS	99	VARILLA DE CAMBIO - FUELLE	131
MANDO LATERAL	71	<b>PISTONES</b>	97	VARILLA DE CAMBIO - TUERCA	131
MANDO PARA CONSOLA	72	<b>SISTEMA DE ESCAPE Y ADMISIÓN</b>	100	<b>SISTEMA DE PROPULSIÓN</b>	135
<b>SISTEMA DE REFRIGERACIÓN</b>	75	<b>SISTEMA DE ADMISIÓN</b>	101	<b>PIEZAS DE HÉLICE</b>	135
<b>ÁNODOS</b>	88	JUNTAS BASE DE LENGUETA	101	ESPACIADOR	135
JUNTA TÓRICA	90	JUNTAS CARBURADOR - COLECTOR ADM.	101	KIT CIERRE HÉLICE	135
JUNTA TAPA DEL ÁNODO	90	JUNTAS COLECTOR	101	PASADOR	135
KITS	90	JUNTAS SILENCIADOR	102	TUERCA HÉLICE	135
TORNILLO INOX	90	JUNTAS TAPA PASO AGUA BLOQUE	101	TUBO GUÍA	135
		JUNTAS TAPA TRANSFERENCIA	101	<b>OEM --&gt; REF</b>	136
		<b>RETENES DE ACEITE</b>	102	<b>REF --&gt; OEM</b>	139
		JUNTAS TAPON DE DRENAJE	102		



# SISTEMA DE ALIMENTACIÓN Y FILTRACIÓN FUEL & FILTRATION SYSTEM

## CONECTORES DE TANQUE

## FUEL TANK CONNECTORS

REF	OEM	
REC65720-98520	5033221	10, 15 HP (2003-05)



REF	OEM		
REC65720-986L0	5032150	6 - 200 HP	3/8"



MORE FILTERS  
13



## FILTRO DE COMBUSTIBLE Y ELEMENTOS

## FUEL FILTERS AND ELEMENTS

### FILTRO COMBUSTIBLE PARA MONTAJE EN LÍNEA IN-LINE FUEL FILTER

REF	OEM		2T STROKES	4T STROKES
REC15410-98500	5032238	E40, E50, E70 J4, J5, J6, J10, J15, J40, J50, J60, J70 BJ40, BJ50, BJ60, BJ70 (2000+)	✓	✓





REF	OEM			
REC40145	0354016 0398327	1/4"	1/4"	plástico plastic
REC40155	0509128 398327	5/16"	5/16"	
REC40165	0360941 398327	3/8"	3/8"	
REC40135	398319	5/16"	3/8"	





REF	OEM		2T STROKES	4T STROKES
REC15410-93J00	5034984	200-225 HP V6	✓	



REF	OEM	
REC433190	433190 765553	60° V4 et V6 (1991-06)





REF	OEM	
REC15410-87J10	5032323 5030702	E25, E30, E40, E50, E70 J30, J40, J50, J60, J70, J90, J115, J140 BJ40, BJ50, BJ60, BJ70, BJ90, BJ115, BJ140 (2000+)





REF	OEM
REC35-49088A2	312456



REF	OEM		2T STROKES	4T STROKES
REC15410-87J30	5035974	J/ BJ25 HP BJ60, BJ70 HP J/ BJ90 HP J/ BJ115 HP J/ BJ140 HP (2005+)		✓



REF	OEM		2T STROKES	4T STROKES
REC5007335	5007326 5005266	3/8"	E-TEC 40, 50, 60, 75, 90, 115, 150, 175, 200 DPL	✓



REF	OEM		2T STROKES	4T STROKES
REC16910-GB2-005	5030183	E5RECS (1998-01) E5RLECS (1998-01)		✓



REF	OEM		2T STROKES	4T STROKES
PAF4-05000300	5040140	4 & 6 HP (1 CYL) (2012-15) 9.8 HP (2 CYL) (2012-15) 15 HP (2CYL) (2012-14)	✓	✓

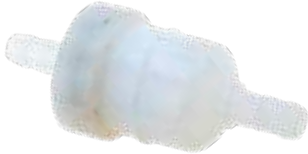



REF	OEM		2T STROKES	4T STROKES
REC65L-24563-00	5035695 0778162	200-225 HP V6	✓	✓





**FILTRO COMBUSTIBLE ALTA PRESION**

**FUEL FILTER HIGH PRESSURE**

REF	OEM		2T STROKES	4T STROKES
REC15440-93J00	5034985	BJ/J200, BJ/J225 6 Cyl (2004-07)		✓



REF	OEM		2T STROKES	4T STROKES
REC15410-87J00	5031400	E40, 50 J40, 50 BJ40, 50 (1999+)		✓



REF	OEM		2T STROKES	4T STROKES
REC15440-99E01	5030706	60, 70 HP (1998-02)		✓



REF	OEM		2T STROKES	4T STROKES
REC15440-90J00	5033704	90-140 HP		✓



**FILTRO COMBUSTIBLE VST BAJA PRESION**



**FUEL FILTER VST LOW PRESSURE**

REF	OEM		2T STROKES	4T STROKES
REC69J-24501-10	5034995	200, 225 HP V6 (2004-07)		✓



## FILTRO DE ACEITE

## OIL FILTER

REF	OEM		2T STROKES	4T STROKES
REC16510-05240	5033102, 7	✓	9.9 - 15 HP (2002-07)	✓
 REC09280-54001	5033009			



REF	OEM		2T STROKES	4T STROKES
REC16510-90J00	5033539 778886	✓	90-115 HP (2003+) EFI	✓



REF	OEM		2T STROKES	4T STROKES
REC434839	434839	✓	9.9 & 15 HP (1995-01) 70 HP (-1998)	✓



REF	OEM		2T STROKES	4T STROKES
REC16510-82703	5033919 778887	✓	140 HP (2003+) EFI	✓



REF	OEM		2T STROKES	4T STROKES
REC16510-87J00	5031411 778885	✓	25-70 HP (1998-05)	✓



REF	OEM		2T STROKES	4T STROKES
REC16510-93J00	5035703 778888	✓	200-225 HP (2004+)	✓



## JUNTA TAPON CARTER

## OIL DRAIN PLUG GASKET

REF	OEM	
REC09168-12012	5030465	30HP+



REF	OEM	
REC09168-12017	5031863 5032987	4-30 HP



## BOMBA DE COMBUSTIBLE

## FUEL PUMP

### BOMBA DE COMBUSTIBLE MECANICA

### FUEL PUMP MECHANICAL

REF	OEM		2T STROKES	4T STROKES
PAF4-04090000	5037518 5033371	✓	4, 5, 6 HP	✓



REF	OEM		2T STROKES	4T STROKES
REC1399-07350	397839	✓	6, 8, 9.9, 15 HP	✓



REF	OEM		2T STROKES	4T STROKES
REC1399-07351	438562	9.9, 15 HP (1993-02)	✓	



REF	OEM		2T STROKES	4T STROKES
REC1399-07352	438556	25 - 50 HP (1976-99) Sin VRO   Without VRO	✓	



REF	OEM		2T STROKES	4T STROKES
REC1399-07353	438555	20 - 30 HP (1990-00)	✓	



REF	OEM		2T STROKES	4T STROKES
REC438559	0438559 0765591	EVINRUDE: BE25, BE35, E25, E35, SE105, SE125 JOHNSON: BJ25, J25, J115, SJ125 (1997-05)	✓	



**BOMBA DE COMBUSTIBLE ELÉCTRICA ALTA PRESIÓN**

**FUEL PUMP, ELECTRIC HIGH PRESSURE**

REF	OEM		2T STROKES	4T STROKES
REC63P-13907-03	5032617 5033702 5036635 5030700	E40, J40, BJ40 E50, J50, BJ50 E70, J70, BJ70 J60, BJ60 (2001-06)		✓



REF	OEM		2T STROKES	4T STROKES
REC5004428	5004428 5000800 0439347	75 HP (2000-03) 90 HP (1998-03) 100 HP (2004-05) 115 HP (1998-06) 135 HP (2000-06) 150 & 175 HP (1999-06) 4 & 6 CYL (3.600 Bore)		✓



REF	OEM	
REC5006063	5006063	200-300 hp



**JUNTAS BOMBA DE COMBUSTIBLE**

**FUEL PUMP GASKETS**

REF	OEM
REC303615	303615



REF	OEM
REC338879	338879



REF	OEM
REC338876	338876



KITS BOMBA COMBUSTIBLE

REF	OEM
REC438616	438616

REF	OEM
REC393088	393088

REF	OEM
REC398514	0398514 398514

KIT, FUEL PUMP

REF	OEM
REC393103	393103

REF	OEM
REC432962	0432962 432962

JUNTAS VST

REF	OEM	
REC15626-99E00	5031114	E/J/BJ 40 - 70 HP (1998-06)

VST GASKETS

REF	OEM	
REC15626-90J00	5033706	BJ90 BJ/J115 BJ/J140

KIT MEMBRANAS

REF	OEM		2T STROKES	4T STROKES
REC15170-98110	5030181	E5 / J5 (1998-01)	✓	

DIAPHRAGM SET

REF	OEM		2T STROKES	4T STROKES
REC15170-94J00	5037584	9.9 - 15 HP (2005-07)		✓

REF	OEM		2T STROKES	4T STROKES
REC15170-91J00	5033372	4 - 5 HP (2003-06) 6 HP (2005-06)		✓

## INYECTORES

## INJECTOR

### INYECTOR COMBUSTIBLE

### FUEL INJECTOR

REF	OEM		2T STROKES	4T STROKES
REC15710-66D00	5032693		60HP (4 CYL) (2002-06) 70 HP (4 CYL) (2001-06)	✓



REF	OEM		2T STROKES	4T STROKES
REC15710-87J00	5031403		40, 50HP (3 CYL) (2002-06)	✓



REF	OEM		2T STROKES	4T STROKES
REC15710-65D00	5033708		90, 100, 115 HP (4 CYL) (203-06)	✓



REF	OEM		2T STROKES	4T STROKES
REC15710-99E00	5030708		70HP (4 CYL) (1998-00)	✓



REF	OEM		2T STROKES	4T STROKES
REC15710-93J00	5035010		200, 225HP (2004-06)	✓



## CARBURADOR

## CARBURATOR

### CARBURADOR COMPLETO

### FULL CARBURATOR

REF	OEM		2T STROKES	4T STROKES
REC13200-91J70	5036549 5036191 5036192		4, 5, 6 HP	✓

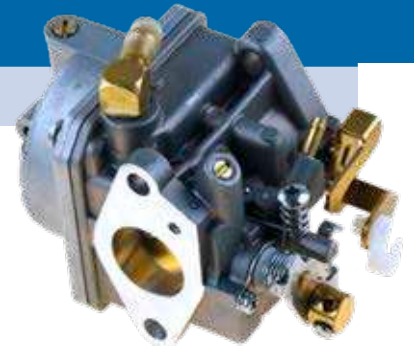

### BOYAS

### FLOATS

REF	OEM		2T STROKES	4T STROKES
REC13250-95D01	5033086		10, 15 HP (2cyl)	✓



REF	OEM
REC396514	0375919 0386149 0396514 0766419



### KIT AGUJA CARBURADOR

### NEEDLE VALVE, KIT

REF	OEM
REC396522	379312 396522



REF	OEM
REC396521	378895 396521 678882



KITS CARBURADORES

REF	OEM
REC438996	435442 438996



REF	OEM
REC439078	435752
	439078
	435678
	43577 435676



REF	OEM
REC439071	439071
	398532
	383067
	383052
	382049



CARBURETOR KITS

REF	OEM
REC396701	396701
	398729
	392061



REF	OEM
REC439074	4359073



REF	OEM
REC439076	439076
	434888
	435443
	398526
	392550



JUNTAS

REF	OEM
REC338880	0338880 338880



REF	OEM
REC439072	439072
	398452
	391305
	398453



REF	OEM
REC343512	0343512 343512



GASKET

REF	OEM
REC338884	802310
	879010
	0338884



REF	OEM
REC338886	802302 0338886



ACELERADOR

ACCELERATOR

CABLES DE ACELERADOR

THROTTLE CABLE

REF	OEM	🔧
REC0433325	433325	8
REC0435230	435230	15 (1989+)
REC0500581	500581 396161	20, 25, 30 (1986+)
REC0398243	398243	25 (1989+)
REC0439542	439542	35
REC0397004	0397004 397004	6 (1968-90), 8 (1968-90)
REC0355911	355911	

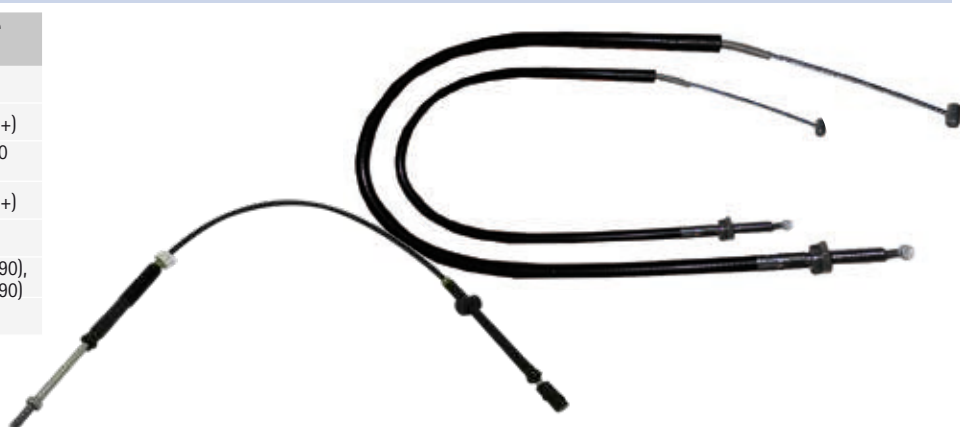

**LEVA ACELERADOR** **ACCELERATOR CAM**

REF	OEM	
REC0323327	0323327	2 - 15 HP



**RETENEDOR** **RETAINER**

REF	OEM
REC315232	0315232 315232



**SISTEMA ELÉCTRICO**

**ELECTRIC SYSTEM**

**SENSORES** **SENSORS**

**SENSOR MAP/MAT** **MAP/MAT SENSOR**

REF	OEM		2T STROKES	4T STROKES
REC18590-72F21	5033780	200, 225 HP 90, 115, 140 HP		✓



**SENSOR IAT** **IAT SENSOR**

REF	OEM		2T STROKES	4T STROKES
REC13650-52G00	5031392	40, 50, 90, 115, 140, 200, 225 HP		✓



REF	OEM		2T STROKES	4T STROKES
REC13650-56B00	5030687	60, 70 HP		✓



**SENSOR IAC** **IAC SENSOR**

REF	OEM		2T STROKES	4T STROKES
REC18137-52D00	5035412	200, 225 HP (2003-08)		✓



**SENSOR CMP**

**CMP SENSOR**

REF	OEM	2T STROKES	4T STROKES
REC33220-76G02	5031468 5032786	40, 50, 90, 115, 140 HP	✓



**BOBINAS**

**COILS**

**BOBINA**

**COIL**

REF	OEM	2T STROKES	4T STROKES
REC33410-94400-000	5032732	10 - 15 HP (2002-04)	✓



REF	OEM
REC584561	584561 582366 583737



REF	OEM
REC0502880	581407



REF	OEM
REC0583740	583740



REF	OEM
REC0502890	502890 582160 584632



REF	OEM
REC0584477	584477



REF	OEM
REC0582508	582508



**GUÍA DE BOBINAS**

**GUIDE, COILS**

KIT			UNIT	KIT			UNIT	KIT			UNIT
1.5, 2 COLT, JR.	1968-90	REC0584477	1	5	1985-91	REC0582508	2	9.5	1964-73	REC0584477	2
2, 2.2, 3	1995	REC0583740	1	5.5 - 6	1950-76	REC0584477	2	9.9, 15	1974-76	REC0502880	2
3	1952-68	REC0584477	1	6	1977-84	REC584561	2	9.9, 15	1977-84	REC584561	2
4	1950-76	REC0584477	1	6	1985-90	REC0582508	2	9.9, 15	1985	REC0582508	2
4	1981-89	REC0584477	1	6.5 COMM	1989-90	REC0582508	2	9.9,15	1993-95	REC0583740	1
4 DELUXE	1977-80	REC584561	1	6.8	1991-99	REC0583740	1	9.9, 15 (4T/Stroke)	1994	REC584561	2
4.5	1980-84	REC584561	2	7.5	1954-58	REC0584477	2	10 - 15	2002-04	REC33410-94400-000	2
4.5	1986-87	REC0582508	2	7.5	1980-84	REC584561	2	10	1951-63	REC0584477	2
5	1950-76	REC0584477	2	8	1980-84	REC584561	2	10, 14 COMM	1989-90	REC584561	2
				8	1985-90	REC0582508	2	14	1988	REC584561	2

KIT				KIT				KIT			
			UNIT				UNIT				UNIT
15	1951-72	REC0584477	2	50	1985-88	REC0582508	2	115	1973-74	REC0502890	4
18	1951-72	REC0584477	2	55	1978-84	REC584561	2	115	1978-94	REC584561	4
20	1951-72	REC0584477	2	60	1978-84	REC584561	2	120	1985	REC0582508	4
20	1985	REC0582508	2	60	1985	REC0582508	3	125	1971-72		1
25	1951-72	REC0584477	2	60 SST	1989-90	REC0582508	3	125	1991	REC0582508	4
25	1977-84	REC584561	2	65	1971-75	REC0502890	3	125 COMM	1989	REC0582508	4
25	1985	REC0582508	2	65	1979-84	REC584561	3	135	1973-75	REC0502890	4
25 COMM	1985-91	REC0582508		65 COMM	1985	REC0582508	3	140	1978-84	REC584561	4
25 COMM	1956-70	REC0584477	2	70	1974-75	REC0502890	4	140	1985	REC0582508	4
28	1987-88	REC584561	2	70	1979-84	REC584561	3	150	1979-84	REC584561	6
28	1997-98	REC0583740	2	70	1985	REC0582508	3	150 (A)	1985	REC0582508	6
28	1989	REC0582508	2	70	1974-74	REC0502890	1	155 COMM (A)	1984	REC0582508	6
30	1956-70	REC0584477	2	75	1979-84	REC584561	3	2500 CC	1988	REC0582508	6
30	1977-84	REC584561	2	75	1985	REC0582508	3	175 V6	1991-99	REC0583740	3
30	1985	REC0582508	2	85	1969-72		1	175	1979-84	REC584561	6
33,35	1956-70	REC0584477	2	85	1973-75	REC0502890	1	175 (A)	1985	REC0582508	6
35	1977-84	REC584561	2	85	1978-84	REC584561	4	185	1984	REC0582508	6
40	1960-73	REC0584477	2	85	1985	REC0582508	4	200	1979-84	REC584561	6
40	1974	REC0502880	2	88	1978	REC0582508	4	200	1985	REC0582508	6
40	1977-84	REC584561	2	90	1978-84	REC584561	4	225	1986	REC0582508	6
40	1985-88	REC0582508	2	90	1985-94	REC0582508	4	235	1979-84	REC584561	6
40 COMM	1985-90	REC0582508	2	90	1995-99	REC0583740	2	250	1991	REC0582508	8
45 COMM	1985-92	REC0582508	2	100	1971-72		1	275	1985	REC0582508	8
45 SS	1987-90	REC0582508	2	100	1978-84	REC584561	4	300, 3.6	1985	REC0582508	8
45	1989-96	REC0583740	2	100	1985	REC0582508	4	SAIL DRIVE	1978-84	REC584561	2
48	1987	REC0582508	2	1600 CC	1988	REC0582508	4	SAIL DRIVE	1985	REC0582508	2
50	1971-75	REC0502890	2	110	1986-90	REC0582508	4				
50	1978-84	REC584561	2	115	1969-70		1				

## BUJÍAS

## SPARK PLUG

### JUEGOS DE CABLES, ALTO RENDIMIENTO

### HD SPARK PLUG WIRE SET

Núcleo del cable de Kevlar de 8 mm antimagnético. Funda de silicona amarilla. Terminales bujías con muelle de acero inox. Terminal del distribuidor de cobre. Terminales bobina. Silicona resistente a altas temperaturas. Garantía de 5 años.

Antimagnetic Kevlar core. Yellow silicone boot & jacket. SS snaplock. Brass distributor terminal. Coil terminals. High resistant silicone. 5 year warranty.

Capuchón de silicona  
Silicone jacket



Rizado especial  
Fiberglass braiding

Terminal de acero inox  
Stainless Steel terminal

Camisa de silicona de 8 mm  
8 mm silicone jacket



Látex resistente altas temperaturas  
Heat resistant latex

Núcleo de Kevlar  
Kevlar core

Acero inox  
Stainless Steel



REF	
REC15-201	5" = 12,7 cm
REC15-202	7" = 17,78 cm
REC15-203	9" = 22,86 cm
REC15-204	12" = 30,48 cm
REC15-101	6"
REC15-102	4"
REC15-103	9"
REC15-104	12"

## CABLES DE BATERIA

## BATTERY WIRES

REF	OEM	
REC584348	584348	10'
REC587012	587012	10'

REC584348



REC587012



## DISTRIBUIDOR

## DISTRIBUTOR

### CONDENSADOR

REF	OEM
REC0580256	0580256 580256



### CONDENSER

REF	OEM
REC0581419	0581419 581419



## MOTORES DE ARRANQUE

## STARTERS

REF	OEM				2T STROKES	4T STROKES
REC0586275	584608 586275	12V	10 CCW	L / E / BE 10 E / BE 15 J / BJ 10, 15 (1995-04) 9.9 - 15 HP (305 cc)		✓



REF	OEM				2T STROKES	4T STROKES
REC50-8M0147039	5040786	12V	9 CCW	E15 / B15 (2012+)		✓



REF	OEM				2T STROKES	4T STROKES
REC31100-95J01	5036972	12V	9 CCW	J25 / BJ25 (2006-11)		✓



REF	OEM			
REC0586278	386591 392133 585061 586278 277432 278232 378674 379091 379818 380139 380238 381864 385401 386597	12V	11	E20 (1976-05), 25 (1976-05), 28 (1976-05), E30 (1976-05), E35 (1976-05), HE25 (1976-05), BE20 (1976-05), BE25 (1976-05), BJ25 (1976-05), BJ30 (1976-05), J25 (1976-05), 30 (1976-05), 28 (1976-05), 35 (1976-05), TJ25 (1976-05), SJ25 (1976-05), 30 (1976-05), TE25 (1976-05), VE25 (1976-05), VJ25 (1976-05), VJ28 (1976-05)



REF	OEM				2T STROKES	4T STROKES
REC0585059	5583473 585059 778991	12V	9	VE25 / 28 / 30 TE25 / TE30 J20 / 25 / 30 / 35 TJ25 VJ25 / 28 / 30 / 35 (1988-93)		✓



REF	OEM	⚡	☀️	🔧	2T STROKES	4T STROKES
REC0586279	583482 585056 586279	12V	9	E40 / 48 / 50, TE40 / 50 VE40/ 48 / 50, J40 / 48 / 50 TJ40 / 50, VJ40 / 48 / 50 BE40 / 50 HE40, SE50 HJ40 BJ40 / 50 RJ50 X50 (1989-05)	✓	



REF	OEM	⚡	☀️	🔧	2T STROKES	4T STROKES
REC0586281	383691 384777 386657 391735 585058 585197 586281	12V	9	55 - 75 HP (3 cyl) E70/ 75 BE50 / 60 / 70 J70 / 75 / 65 / 60 TJ60 / 70 VJ60 / 70 E 60 /65 / 70 BJ 60 / 70 (1971-04)	✓	



REF	OEM	⚡	☀️	🔧	2T STROKES	4T STROKES
REC31100-87J00	5030780	12V	8	E70 / B70 (1998-00)	✓	



REF	OEM	⚡	☀️	🔧	2T STROKES	4T STROKES
REC0586287	438878 586257	12V	8	75 - 175 HP (1991+) V4 et V6 Ficht	✓	



REF	OEM	⚡	☀️	🔧	2T STROKES	4T STROKES
REC31100-90J01	5033799	12V	9	J90 / BJ90 J115 / BJ115 J140 / BJ140 (2003-06)	✓	



REF	OEM	⚡	☀️	🔧	2T STROKES	4T STROKES
REC0586283	385529 389954 585057 585196 586282 586283 386465 389380 391554 585051	12V	10	80 - 140 HP (1973-98) V4 CROSS	✓	



REF	OEM	⚡	☀️	🔧	2T STROKES	4T STROKES
REC0586284	584980 586284	12V	8	100 Comercial 1997, 80 Jet 1998 E90 / J90 / BJ90 / BE90 E115 / BE115 / HE115 / L115 J115 / BJ115 / SJ115 (1995-06) V4	✓	



REF	OEM				2T STROKES	4T STROKES
REC0778994	393570 585060 586285 778994	12V	10	120 - 140 HP (1985+)	✓	



REF	OEM				2T STROKES	4T STROKES
REC0778292	387094 395207 585062 586288 778992 777693	12V	8	150 - 235 HP V6 Cross	✓	



REF	OEM				2T STROKES	4T STROKES
REC31100-96J02	5035078	12V	9	J200, BJ200 J225, BJ225 (2004-06)		✓



REF	OEM				2T STROKES	4T STROKES
REC0586957	391511 397023 396235 584799 586890 384799 586289 586411 586731 586897 586957	12V	10 CCW	V6 - V8 (115 - 300 HP) (1985+) Looper	✓	



MUELLES ARRANQUE

REWIND SPRING

REF	OEM
REC93-08668	395460
REC93-06511	312932
REC93-06522	323653 338534



MUELLES ARRANQUE  
GUIA

REWIND SPRING  
GUIDE

	REF
2	1969-80 REC93-06511
3	1954-68 REC93-08668
4	1969-92 REC93-06511
4	1969-80 REC93-06511
4.5	1980-90 REC93-06511

	REF
5.5	1954-68 REC93-08668
7.5	1954-68 REC93-08668
9.9	1980-92 REC93-06522
10	1980-92 REC93-06522
10	1950-63 REC93-08668

	REF
12	1980-92 REC93-06522
12	1956-68 REC93-08668
15	1979-92 REC93-06522
15	1956-68 REC93-08668
18	1956-68 REC93-08668

	REF
20	1956-92 REC93-08668
28	1969-92 REC93-08668
25/30	1969-92 REC93-08668
35	1969-92 REC93-08668

MUELLE SEGURO ARRANQUE

STARTER PAWL SPRING

REF	OEM	
REC93-08665	330527	20, 25 HP (1985-97)



## UÑAS ARRANQUE MANUAL

REF	OEM	UÑAS ARRANQUE MANUAL
		2 1971-88
	JR / COLT	1990
		3 1957-67
		4 1978-90
		5.5 1957-64
		7.5 1957-76
		10 1957-62
REC300-01744	203698	18 1957-73
		25 1969-76
		25 1977
		35 1976-77
		45 1958-59
		50 1958-89
		60 1964-66
		75 1960-65
		80 1966



## STARTER PAWL

REF	OEM	STARTER PAWL
		20 1981-90
		25 1978-90
REC300-01633	330525	25C 1982-90
		30 1957-61
		30 1984-90
		35 1978-90



## LLAVES DE ARRANQUE

REF	OEM	LLAVES DE ARRANQUE	2T STROKES	4T STROKES
REC5005801	5005801 0175974	10 - 200 HP (1996+)	✓	✓



## IGNITION STARTER SWITCH

REF	OEM	IGNITION STARTER SWITCH
MP28870	585134	



REF	OEM	LLAVES DE ARRANQUE
REC5007497	5007494	1996 +



## DESCONECTORES DE SEGURIDAD

REF	OEM	DESCONECTORES DE SEGURIDAD
REC37820-92E03	5031481	



## CUT OFF SWITCHES



REF	OEM	CUT OFF SWITCHES
REC37830-89E03	5030225 5032047	



REF	OEM	DESCONECTORES DE SEGURIDAD
REC176288	176288	1996+
REC432230	432230	-1995





## SOLENOIDE RELÉ



REF	OEM			
REC89-825096T01	5030783	9.9 - 70 HP (1998+)	12 V	4



## SOLENOID RELAY

REF	OEM			
REC584580	584580	9.9 / 15 HP (4 T/Stroke) (1995-01) 8 HP (1996-98) 9.9 / 15 HP (1993+)	12 V	4





REF	OEM			
REC0586180	582708 395419 380095 383622 389398 389493 586180	20 - 300 HP (1992+)	12 V	4





REF	OEM		2T STROKES	4T STROKES
REC38860-76F01	5033264	10 - 225 HP		✓





REF	OEM			
REC3857533	584416 581295 582472 582473 586147 586224 777702	40 - 300 HP (1991+)	12 V	4



REF	OEM			
REC586774	586774 5009214	25 - 300 HP (2004+) E-Tec	12 V	4



REF	OEM			
REC3853839	586730 586842 778209 980801 981703 982189 985064 385389	75 - 250 HP (1997+)	12 V	4



## TRIM

REF	OEM		2T STROKES	4T STROKES
REC0586767	0586767 586767	15-300 HP (E-TEC)	✓	

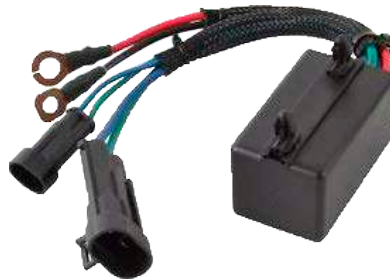

## REGULADORES Y RECTIFICADORES

REF	OEM		2T STROKES	4T STROKES
REC32800-94620	5034255	4, 5, 6 HP		✓



## REGULATOR AND RECTIFIERS

REF	OEM
REC8M0058226	509219



REF	OEM	2T STROKES	4T STROKES
REC32800-95D01	5030356	5 - 15 HP (1998+)	✓



REF	OEM	2T STROKES	4T STROKES
REC32800-89J00	5032030	E25, E30 (2000-01)	✓



REF	OEM	2T STROKES	4T STROKES
REC0585081	0585081	10, 15 HP	✓



REF	OEM	2T STROKES	4T STROKES
REC32800-89J11	5034680	J25, J30	✓



REF	OEM	4-5 A	1974-92
REC581778	581778	4-5 A	9.9, 15
			20 (D)
			25
			28
			30 (D)
			35
			40
			45
			45SS
			48
			55(A)



REF	OEM	25 - 35 HP (1995+)	2T STROKES	4T STROKES
REC300-03588	584890	25 - 35 HP (1995+)	✓	



REF	OEM	40, 50 HP	2T STROKES	4T STROKES
REC32800-38F10	5036107	40, 50 HP		✓



REF	OEM	10, 15 HP	2T STROKES	4T STROKES
REC32800-94J11	5036261	10, 15 HP		✓



REF	OEM	BJ40, BJ50, J40, J50	2T STROKES	4T STROKES
REC32800-87J10	5032615	BJ40, BJ50, J40, J50		✓



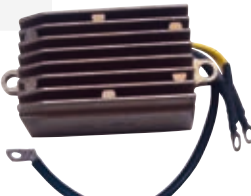

REF	OEM	25 - 70 HP (1992+)	2T STROKES	4T STROKES
REC300-03587	585001	25 - 70 HP (1992+)	✓	

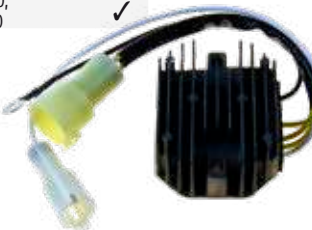

REF	OEM	J60, BJ60, J70, BJ70	2T STROKES	4T STROKES
REC32800-92E20	5030795	J60, BJ60, J70, BJ70		✓





REF	OEM		2T STROKES	4T STROKES
REC32800-90J00	5033820 5036618			90-115 HP ✓



Cuerpo reciclado      Recycled housing

REF	OEM		2T STROKES	4T STROKES
REC0585195	583529 584204 585195		90, 100, 115, 150, 175 HP	(1989-98) ✓



REF	OEM		2T STROKES	4T STROKES
REC0586271	586271 584641 585995		200, 225, 250 HP	(1993-99) ✓

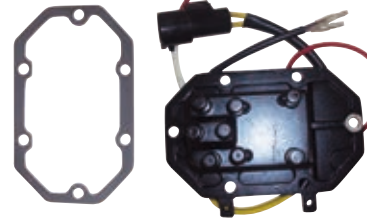

REF	OEM		2T STROKES	4T STROKES
REC32800-93J03	5036637		BJ200, BJ225	✓



APPLICATION  
68

CDI Y CAJAS NEGRAS

CDI & POWER PACK

REF	OEM
REC0584028	583773 584027 584028



REF	OEM		2T STROKES	4T STROKES
REC115742	115742		3.3 HP	(1995+)

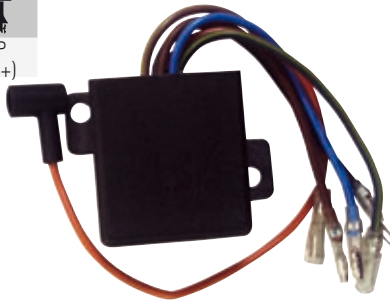

REF	OEM
REC0586798	584783



REF	OEM
REC0586697	396141 582281 582285 582502 582757 582880 583167 583168 583169 583170 583175 583604



REF	OEM	
REC0582452	582453 583380	3



REF	OEM
REC0582901	582474 582864 582901





REF	OEM
REC5001344	584767
	584768
	584908
	585074



REF	OEM
REC0583748	583748



REF	OEM
REC0583320	583122
	583320



STARTOR

REF	OEM	⚡
REC0763769	583410	9 A
	763769	

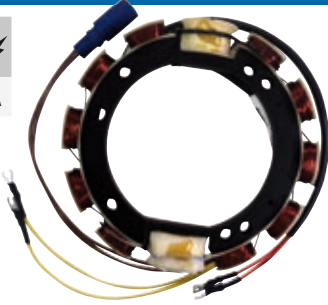

REF	OEM	⚡
REC0763763	584560	6 A
	763763	
REC0763779	584643	35 A
	763779	



REF	OEM	⚡
REC0763765	583415	35 A
	584287	
	763765	

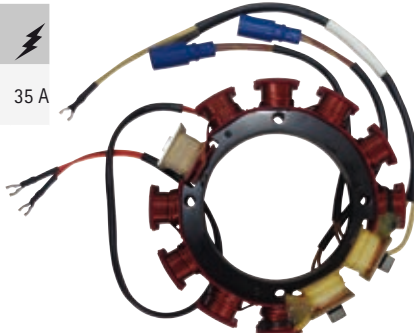

REF	OEM	⚡
REC0763764	583710	35 A
	584292	
	763764	

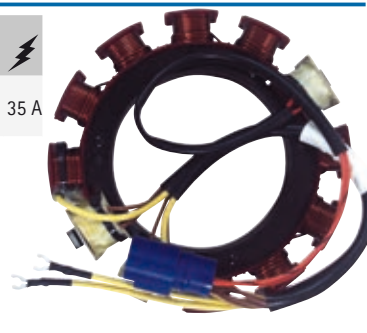

REF	OEM	⚡	🔧
REC0763759	584109	35 A 6 cyl	
	584981		

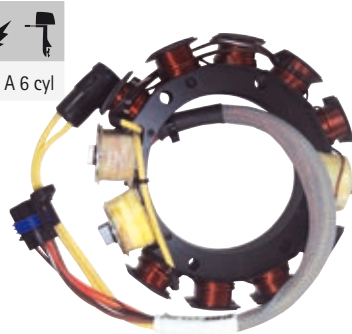

REF	OEM	⚡
REC0763767	583340	9 A
	583536	
	763767	



## GUÍA



## APPLICATION

	CYL	CAJA NEGRA POWER PACK	STARTOR	TRIGGER
3.3	2	1995	REC115742	
4	2	77-84	REC0582452	
4, 4.5, 5	2	1985	REC0586697	
4	2	1994-96	REC0586697	
5	2	1993-98	REC0586697	
6	2	1977-84	REC0582452	
6, 8	2	1985	REC0586697	
6	2	1994-00	REC0586697	
8	2	1994-03	REC0586697	
9.9	2	1985-88	REC0586697	
9.9	2	1993	REC0586798	
9.9	2	1994-95	REC0586798	
9.9 MAN.	2	1996-05	REC0586798	
9.9 ELEC.	2	1995-03	REC0586798	
10	2	1994	REC0586798	
14	2	1988	REC0586697	
15	2	1983-84	REC0582452	
15	2	1988	REC0586697	
15	2	1994	REC0586798	
15	2	1995-00	REC0586798	
15 ELEC.	2	1996-97	REC0586798	
15 (4T / Strokes)	2	1996-00		REC32800-95D01
20	2	1982-84	REC0582452	
20	2	1985-88	REC0586697	
20	2	1993-00	REC5001344	
25	2	1982-84	REC0582452	
25	2	1985-88	REC0586697	
25	2	1993-05	REC5001344	
25	3	1994-95		REC0763763
28	2	1985-88	REC0586697	
28	2	1993-98	REC5001344	
30	2	1984	REC0582452	
30	2	1985-88	REC0586697	
30	2	1993-05	REC5001344	
35	2	1982-84	REC0582452	
35	2	1985-88	REC0586697	
35	2	1992-93		REC0763763
35	2	1993-97	REC5001344	
35	2	1993-95		REC0763763
35	2	1996-97		REC0763763
40	2	1985-88	REC0586697	
40	2	1992		REC0763763
40	2	1993	REC5001344	
40	2	1993-95		REC0763763
40	2	1996-97	REC5001344	
40	2	1996-97		REC0763763
40 MAN.	2	2000-05	REC5001344	
40 ELEC.	2	2000-05		REC0763763
45	2	1986-90	REC0586697	
48	2	1987-88	REC0586697	
48	2	1994-96	REC5001344	
50 ELEC.	2	1979-83	REC0582452	
50	2	1979-83	REC0582452	
50	2	1985-88	REC0586697	
50 TE-S	2	1992		REC0763763
50	2	1993-95		REC0763763
50 MAN.	2	1993-95	REC5001344	
50	3	1996-98		REC0763763
50 MAN.	2	1997-99	REC5001344	
50 ELEC ST	2	1997-99		REC0763763
50 MAN.	2	1998-99	REC5001344	
55	2	1979-82	REC0582452	
55	2	1988	REC0586697	
55 COM	2	1983-84	REC0582901	
55 COM	2	1986-87	REC0586697	
60	2	1985	REC0586697	
60	3	1989-91	REC0583748	
60	3	1992	REC0583748	REC0763763
60	3	1993-01		REC0763763
65 COM	3	1986-88	REC0583320	
65 COM	3	1989-95	REC0583748	
65 COM ELEC	3	1993-94		REC0763763
65 COM VRO	3	1995	REC0583748	
65 COM	3	1996-00		REC0763763
70	3	1989-91	REC0583748	



	CYL	CAJA NEGRA POWER PACK	STARTOR	TRIGGER
70	3	1992	REC0583748	REC0763763
70	3	1993-01		REC0763763
85 TJL	4	1991-95	REC0584028	REC0763767
85 TTLW/TRIM	4	1994		REC0763767
85 TTL	4	1995	REC0584028	REC0763767
88	4	1988		REC0763767
88	4	1989-93	REC0584028	REC0763767
88	4	1994		REC0763767
88	4	1994-96	REC0584028	REC0763767
90	4	1989-93	REC0584028	REC0763767
90	4	1994-95		REC0763767
90 20 / 25IN	4	1996-97	REC0584028	REC0763767
100	4	1990-93	REC0584028	REC0763767
100	4	1994		REC0763767
100 COM	4	1989-97		REC0763767
100	4	1989	REC0584028	REC0763767
112 20, 25 IN	4	1994-96	REC0584028	REC0763767
115	4	1990-93	REC0584028	REC0763767
115	4	1994		REC0763767
115	4	1995-96	REC0584028	REC0763767
115 20,25 IN	4	1997	REC0584028	REC0763767
120 Looper	4	1988-90		REC0763769
120 10 Amp.	4	1992-94		REC0763769
125	4	1991-94		REC0763769
125 COM ELEC.	4	1989-95		REC0763769
130	4	1995-00		REC0763769
135	4	2001		REC0763769
140 Looper	4	1988-95		REC0763769
150 SL/ST	6	1989-90		REC0763764
150 ST	6	1990		REC0763764
150 SL/ST	6	1991		REC0763764
150	6	1992-06		REC0763759
155 COM	6	1989-92		REC0763764
175	6	1989-90		REC0763764
175GL/EK/EL/NX	6	1991-06		REC0763759
175	6	1992-98		REC0763759
185	6	1990-92		REC0763765
200	6	1988-92		REC0763765
225	6	1988-92		REC0763765
225	6	1993-00		REC0763779
250	8	1993-95		REC0763779
250	8	1997		REC0763779
300	8	1993-95		REC0763765
1.6L	4	1988-90		REC0763767
3.0L	6	1988-90		REC0763765
4.0L	8	1989-90		REC0763765

# TRIM, TILT & POWER TRIM



## MOTOR TRIM COMPLETO

REF	OEM				2T STROKES	4T STROKES
REC0584107	387277					
	582048					
	582155	3, 4, 6 Cyl (1981+)	3	3	✓	
	584107					
	582047					
	777784					





REF	OEM				2T STROKES	4T STROKES
REC0393988	391264					
	393259					
	393988	3, 4, 6 & 8 Cyl (1981+)	3	2	✓	
	394176					
	983019					



REF	OEM				2T STROKES	4T STROKES
REC5005831	5005822					
	5005831	J/E 15- 90	4	2	✓	
	5005875	HP (2004+)				
	5006479					





REF	OEM				2T STROKES	4T STROKES
REC0433226	433226	40, 48, 50 HP (1989+)	4	2	✓	





## COMPLETE TRIM ASSEMBLY

REF	OEM				2T STROKES	4T STROKES
REC38100-87J00	5031482	E40 / E50 (1999-06)	4	2		✓





REF	OEM				2T STROKES	4T STROKES
REC5031482	5032670	E40 / J40 / BJ40				
	5036081	E50				
	5032670	J50 / BJ50 (2001-04)	4	2		✓
	5031482	J/BJ 40, 50 (1999-06)				



REF	OEM				2T STROKES	4T STROKES
REC38100-96J00	5033838	J60 / 70 / 90 / 115 / 140				
	5034526	/ 200 / 225				
	5034627	BJ60 / 70 / 90 / 115 /	4	2		✓
	5035113	140 / 220 / 225				
	5035513	(2003-06)				







REF	OEM				2T STROKES	4T STROKES
REC5005376	434495	60, 70, 90, 115, 150, 175,				
	434496	200, 225 HP (1991+)				
	438529	120 - 140 HP (1991-94)	4	2		✓
	5005374	50 HP (3 cyl)				
	438531	60 JP V4 - 130 HP				



REF	OEM				2T STROKES	4T STROKES
REC5006319	5006319 5005838 5005817	E75, E90, E115, E130 (2004+) J40, J50 (2005) E-TEC	4	2	✓	





REF	OEM				2T STROKES	4T STROKES
REC5005254	437801 435532 439937 5005254 438786	75-250 HP (1998+) Heavy Duty, J Suffix 25, 40, 48, 50 HP (1992+) Hollow hex. shaft.	4	2	✓	





SENSOR DE TRIM

TRIM SENSOR

REF	OEM		2T STROKES	4T STROKES
REC34801-93J03	5035099 5036277	J, BJ200HP J, BJ225 HP		✓



REF	OEM		2T STROKES	4T STROKES
REC34801-99E04	J, BJ40 J, BJ50 J, BJ60 J, BJ70 5036054 5031474 5031116 J30 J, BJ90 J, BJ115 J, BJ140			✓



RELÉ DE TRIM

TRIM RELAY

REF	OEM		2T STROKES	4T STROKES
REC38410-93J12	5036701 5034606	40- 300 HP		✓



INSTALACIÓN ELÉCTRICA

WIRING HARNESS

KIT CONVERSIÓN  
Sustituye de 2 a 3 cables.

CONVERSION KIT  
Converts 3-wire Tilt and Trim motors to 2-Wire design

REF	OEM
REC84-819514T26	84-819514T26
REC84-819514T26	84-826075A2
	84-826802A4



TAPON PISTÓN TRIM

PLUG PISTON TRIM

REF	OEM	
REC48630-94900	5030870	J70



REF	OEM	
REC48630-92J00	5033935	J, BJ140 HP



# SISTEMA DE GOBIERNO



# STEERING SYSTEM

## MANDOS DE CONTROL

## ENGINE CONTROLS



### MANDO LATERAL

### SIDE CONTROL

REF	OEM	TRIM		
REC5006180	5006180	✓	✓	BRP 1996+

REF	OEM	TRIM		
REC5006181	5006181	✓	✓	BRP 1974+



REF	OEM	TRIM		
REC5006561	5006561	✓	✓	BRP 1996+





MANDO PARA CONSOLA

CONSOLE CONTROL

REF	OEM	TRIM		
REC5006182	5006182	✓		BRP 1996+
REC5006184	5006184	✓		BRP 1996+



REF	OEM	TRIM		
REC5006186	5006186	✓	✓	BRP 1996+



# INTERRUPTORES Y CABLES

# SWITCHES & CABLES

## INTERRUPTOR TRIM

## TRIM SWITCH

REF	OEM	
REC5006358	5006358	REC5006180 REC5006358 REC5006561
REC5007485	5007485	REC5006182 REC5006186
REC764666	764666	REC5006184



## ARNÉS



## HARNESS

REF	OEM	
REC176339	176339	12 FT
REC176340	176340	15 FT
REC176341	176341	20 FT
REC176342	176342	28 FT



EXTENSIÓN DE ARNÉS

HARNESS EXTENSION

REF	OEM		
REC176333	176333	5 FT	
REC176334	176334	10 FT	1996+
REC176335	176335	20 FT	



REC176333



REC176334  
REC176335

ARNÉS ADAPTADOR  
ELECTRÓNICO CDI

HARNESS EXTENSION, CDI

REF	OEM		
REC423-6349	176349	18 FT	Adapta motores 1996-16 a mandos de 1976-95 Adapts 1996-16 Engines to 1976-95 Controls



INTERRUPTOR MANDO

CONTROL SWITCH

REF	OEM
REC0176408	176408

REF	OEM
REC5007497	5007497



# SISTEMA DE REFRIGERACIÓN

# COOLING SYSTEM

## TERMOSTATO

## THERMOSTAT

### TERMOSTATO

REF	OEM		°C
REC6F5-12411-03	434841 5005440	6-55 HP, V4, V6 Crossflow	61°



REF	OEM		°C
REC435491	435491	V4, 90-115 HP (1995+) V6, 150-175 HP (1991+)	61°



REF	OEM		°C
REC878904	436195	9.9, 15, 40, 48, 50 HP 3 Cyl, V4	61°



REF	OEM		°C
REC437090	437090	V6 OFFSHORE Acero Inox. Flujo bajo. Stainless Steel. Lower flow.	56°



REF	OEM		2T STROKES	4T STROKES	°C
REC17670-94J01	5036226	J/BJ25		✓	60°



REF	OEM		2T STROKES	4T STROKES	°C
REC17670-91J01	5033385	2, 4, 5 hp		✓	50°



### THERMOSTAT

REF	OEM		2T STROKES	4T STROKES	°C
REC17670-93962	5030742 5031175	J/BJ 70-140 HP		✓	50°



REF	OEM		2T STROKES	4T STROKES	°C
REC17670-94402	5031758	10 - 70 HP		✓	60°



REF	OEM		2T STROKES	4T STROKES	°C
REC17670-87J00	50317562	40 - 70 HP		✓	72°



REF	OEM		2T STROKES	4T STROKES	°C
REC17670-90J10	5033722	J/BJ 90 - 225 HP		✓	71°



REF	OEM		2T STROKES	4T STROKES	°C
REC67F-12411-01	5033721	J/BJ140		✓	60°



REF	OEM
REC394411	0394411 394411

Vernatherm 65 HP (Year: 1971-90)  
Vernatherm 85 HP (Year: 1971-90)  
Vernatherm 100 HP (Year: 1971-90)  
Vernatherm 115 HP (Year: 1971-90)  
Vernatherm 135 HP (Year: 1971-90)



REF	OEM
REC396987	0396987 396987



**JUNTAS TERMOSTATO** **THERMOSTATO GASKETS**

REF	OEM		GOMA RUBBER	CORCHO CORK
REC0329319	329319	2 Cyl, Crossflow 8 - 30 HP	✓	
REC3852120	313416	3 CYL		✓
REC27-62386001	310058	2 Cyl, Crossflow 90° V6 Crossflow	✓	
REC321932	0321932 321932			✓
REC339044	0339044 339044		✓	





**RETÉN** **RETAINER**

REF	OEM
REC321120	0321120 321120 5006373





**CUBIERTAS TERMOSTATO** **THERMOSTATO COVER**

REF	OEM	
REC338632	338632	60° V4, V6



**JUNTAS TAPA DE REFRIGERACIÓN** **GASKET, EXHAUST INNER COVER**



REF	OEM	
REC336947	336947	5, 6, 8, 10, 15 HP (1991-01)



REF	OEM	
REC329830	329830	2, 3 Cyl Loopcharged 90° V4 Loopcharged



**NIPLE** **NIPPLE**

REF	OEM		
REC321886	321886	3/8	9.9 - 15 HP(1978-95) 20 - 35 HP (1978-80) 3 Cyl, V4 (-1978), V6 (1978-92) 40 - 60 HP, 2 Cyl (1978-91) V6 (1987-90) Loopcharged V8 (1986-91) Con dirección hidráulica. With Power Steering.

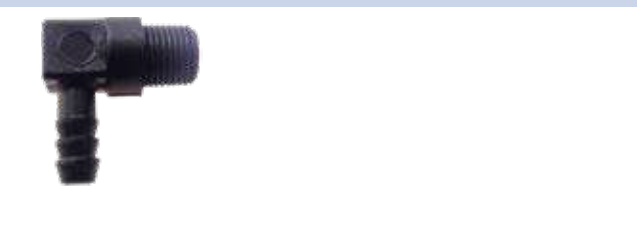

**KIT TAPÓN**



**PLUG WATER FLUSH**

REF	OEM			OEM
REC17913-93J00	5035054	J/BJ 25 - 225 HP	REC17914-93J00	5035055



**GUÍA DE TERMOSTATO**

**THERMOSTAT GUIDE**

		TERMOSTATO THERMOSTAT			TERMOSTATO THERMOSTAT			TERMOSTATO THERMOSTAT
5	1965-68, 86	REC6F5-12411-03	40	1960-69	REC6F5-12411-03	100	1979-80	REC6F5-12411-03
5.5	1959-64	REC6F5-12411-03	45	1989-92	REC6F5-12411-03	100	1990-95	REC6F5-12411-03
6	1965-79, 86	REC6F5-12411-03	50	1971, 75, 79, 81, 86	REC6F5-12411-03	100 Comm	1984-95	REC6F5-12411-03
7.5	1980-86	REC6F5-12411-03	55	1976-92	REC6F5-12411-03	110	1985-89	REC6F5-12411-03
8	1986	REC6F5-12411-03	60	1980-86	REC6F5-12411-03	112	1994-95	REC6F5-12411-03
9.5	1964-73	REC6F5-12411-03	60,60 TTL	1993	REC878904	115	1978-95	REC6F5-12411-03
9.9	1974-86	REC6F5-12411-03	65	1993	REC878904	140	1978-85	REC6F5-12411-03
10	1959-63	REC6F5-12411-03	65Jet	1994-95	REC6F5-12411-03	150	1978-91	REC6F5-12411-03
15	1974-86	REC6F5-12411-03	70,70 TTL	1993	REC878904	155	1984-91	REC6F5-12411-03
18	1959-73	REC6F5-12411-03	80Jet	1994-95	REC6F5-12411-03	175	1977-91	REC6F5-12411-03
20	1981-94	REC6F5-12411-03	85	1978-80	REC6F5-12411-03	185	1984-85	REC6F5-12411-03
25	1969-94	REC6F5-12411-03	85	1993-95	REC6F5-12411-03	200	1977-83	REC6F5-12411-03
28	1989-94	REC6F5-12411-03	88	1987-95	REC6F5-12411-03	235	1978-85	REC6F5-12411-03
30	1986-94	REC6F5-12411-03	90	1983-95	REC6F5-12411-03			
35	1959-76, 94	REC6F5-12411-03	90 Jet	1994	REC6F5-12411-03			

**GUÍA DE IMPULSORES**

**IMPELLER GUIDE**

REF	OEM	A	B	C	CHAVETA KEY	REF	OEM	A	B	C	CHAVETA KEY
REC0767407	433935	11,28	34	17,56		REC777214	396809	16,04	70	22,3	
REC386084	386084	12,75	38,6	17,6	REC300611	REC432941	432941	19,13	91,30	25,40	REC334897
REC395289	395289	16	51	19		REC434424	434424	11	69	12,8	REC300611
REC765431	382547	19,25	91,5	25,4		REC389576	389576	11,2	38,4	17,9	REC300611
REC775518	375638	12,7	69	12,8		REC763735	436137				
REC396725	396725	19,13	91,5	25,4	REC334897	REC763735	387361	11,2	38,4	17,9	
REC777213	377230	16,04	69,8	22,1		REC390286	390286	17,5	51,5	19	
REC385072	385072	19,15	89	31,9		REC17461-98503	5030188	10,15	41	14	REC09420-03002
REC777212	389642	22,32	89	31,9		REC17461-93903	5033112	13,2	42	22	REC17462-93990
REC777129	389589	16,04	69,20	22,25	REC300611	REC17461-96312	5031417	17,1	67,5	16,18	REC09420-04006
REC5001593	435821 5001593	22,41	89	31,9	REC331107	REC17461-87E12	5030723	22,2	78,3	35,1	
						REC17461-90J01	5033542	24,3	86	31,7	REC09420-05009

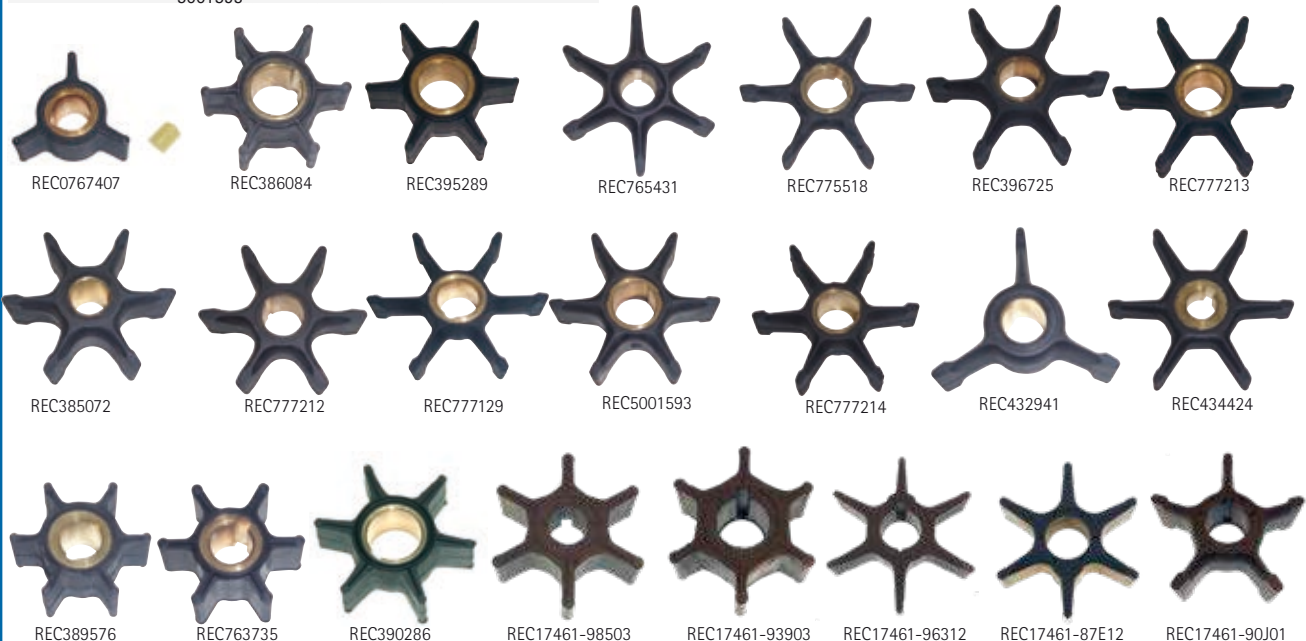
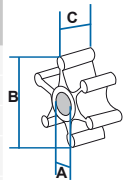

**CHAVETA**

**KEY**

REF	OEM	2T STROKES	4T STROKES	Icon	Material	Image
REC334897	334897	✓			Plástico Plastic	

REF	OEM	Icon	2T STROKES	4T STROKES	Icon	Material	Image
REC09420-03005	5033113				✓	INOX / SS	

REF	OEM	Icon	2T STROKES	4T STROKES	Material	Image
REC09420-04006	5031281		25, 30, 40, 50 HP	✓		

REF	OEM	2T STROKES	4T STROKES	Material	Image
REC300611	300611	✓		INOX / SS	

REF	OEM	Icon	2T STROKES	4T STROKES	Material	Image
REC09420-03002	5030137		4, 5, 6 HP	✓		

REF	OEM	Icon	2T STROKES	4T STROKES	Material	Image
REC17462-93990	5033113		10, 15 HP	✓		

REF	OEM	Icon	2T STROKES	4T STROKES	Material	Image
REC09420-05009	5034842 5033632 5084842		90, 115, 140 HP 200, 225 HP	✓		

REF	OEM	Material	Image
REC331107	331107		

REF	OEM	Material	Image
REC308928	0308928 308928		

REF	OEM	2T STROKES	4T STROKES	Icon	Material	Image
REC331901	0331901 331901 0344470			✓	Plástico Plastic	
REC344470	330619 344470					

**RETENES**

**SEAL**

**RETENES**

**GEARCASE SEAL**

REF	OEM	EJE SHAFT	CALIBRE BORE
REC342786	332205	0.7500	1.2500
REC332261	332261	0.6250	1.3750
REC911685	911685	2.0000	2.5000
REC3853655	916058	0.5000	0.9062
REC3852548	3852548	1.3750	2.1875
REC321895	321895	1.5625	1.9219
REC321928	321928	0.6250	1.3750
REC324639	324639	0.4375	0.9375
REC327031	327031	0.4375	0.8750
REC329922	329922	0.8125	1.3750
REC329923	329923	0.8750	1.3750
REC330137	330137	1.1250	1.6250
REC26-419533	313992	1.1875	1.8750
REC318972	318972	0.5000	0.8750
REC26-76868	320862	1.1875	1.6875
REC26-69188	321453	0.8750	1.2500
REC321459	321459	0.6250	1.1250
REC321466	321466	0.7500	1.1250
REC321467	321467	1.0000	1.3750
REC321480	321480	0.5000	1.2500
REC321481	334950	1.2500	1.6875
REC342786	342786	0.7500	1.1875



GUÍA RETENES

GEARCASE SEAL APPLICATION

		EJE HÉLICE PROP SHAFT	UN.	EJE COLA DRIVE SHAFT	UN.
1.5, 2, 2.5, 3	1958-68		1	REC327031	1
1.5, 2	1968-90	REC327031	1	REC327031	1
2.5, 4	1973-80	REC327031	1	REC327031	2
2.5	1987	REC324639	2	REC327031	2
2.5, 4	1981-95		1	REC327031	2
3 Weedless	1958-68	REC327031	1		1
4	1981-90	REC324639	2		1
4	1984, 1986-95		1	REC324639	2
4.5, 7.5	1980-87		1	REC324639	1
5, 6, 8	1980-87		1	REC324639	2
9.9	1974-83	REC321481	1	REC321480	1
9.9	1984-95	REC321481	1	REC321480	1
10	1989	REC321459	1	REC321459	1
14	1988-90	REC321459	1	REC321459	1
15	1974-83	REC321481	2	REC321480	1
15	1984-95	REC321481	2	REC321480	1
20	1983		1	REC321459	1
20	1984	REC318972	1		1
20	1985-86	REC321459	1		1
20	1985-86	REC26-69188	1	REC321928	1
20	1987-95	REC26-69188	1	REC321928	1
25	1983		1	REC332261	1
25	1984	REC321459	1	REC321459	1
25	1985-86	REC26-69188	1	REC321928	2
25	1987-95	REC26-69188	1	REC321928	1
25 C	1983	REC321459	1	REC321459	1
25 C	1984-90	REC321459	1	REC321459	1
28	1987-90	REC321459	1	REC321459	1
30	1984-86	REC26-69188	1	REC321928	1
30	1987-95	REC26-69188	1	REC321928 (INNER)	1
35	1976	REC26-69188	1	REC321459	2
35	1977-86	REC26-69188	2	REC321928	2
35	1987-90	REC26-69188	2	REC321928 (INNER)	1
40	1974-76		1	REC321481	1
40 C	1981-86		1	REC321481	2
40	1984-85	REC321467	2	REC321466	2
40 (AR, AE, AT)	1988	REC330137	1	REC321459	1
40	1986-89	REC321467	2	REC342786	1
45 C	1985	REC330137	2	REC321459	1
45 C	1986	REC330137	2	REC342786	1
45 C	1987	REC330137	2	REC321459	1
45 C	1988-94	REC330137	2	REC321459	1
45 C	1995	REC330137	2	REC342786	1
48	1988-95	REC321467	2	REC321466	1
50 (Manual)	1971-74	REC330137	2	REC321459	2
50	1975	REC321467	2	REC321466	1
50	1979	REC330137	2	REC321459	2
50	1980	REC321467	2	REC321466	1
50/60 (Pull Start)	1981-83	REC330137	2	REC321459	1
50/60 (Electric)	1981-83	REC321467	2	REC321466	1
50/60	1984-85	REC321467	2	REC321466	1
50/60 corto   Small	1986-87	REC321467	2	REC342786	1
50/60 largo   large	1986-87	REC330137	2	REC342786	1
50/60	1988-89	REC330137	2	REC321466	1
50	1990-95	REC321467	2	REC342786	1
55	1968-69		2	REC321466	2
55	1976-77	REC321467	2	REC321466	2
55	1978	REC321466	1	REC321466	2
55	1979-83	REC330137	2	REC321459	1
55 (Electric)	1980-83		2	REC321466	2
55 C	1984	REC330137	2	REC321459	1
55 C	1985	REC330137	2		1
55 C	1986	REC330137	2	REC342786	1
55 C	1987-94	REC330137	2	REC321466	1
55 C	1995	REC330137	2	REC342786	1
60	1970		1	REC321466	2
60 (3-Cyl.)	1971	REC330137	2	REC321466	2
60 (Pull Start)	1980-83	REC330137	2	REC321459	2
60 (Electric)	1980-83	REC330137	2	REC321466	2
60	1970		1	REC321466	2

		EJE HÉLICE PROP SHAFT	UN.	EJE COLA DRIVE SHAFT	UN.
60 SST	1989	REC321467	2	REC342786	1
				REC321466	1
60 SST	1990	REC321467	2	REC342786	1
				REC321466	1
60 (3-Cyl.)	1987-95	REC330137	2	REC342786	1
				REC321466	1
65 (3-Cyl.)	1972-73	REC330137	2	REC321466	2
65 C	1984-85	REC330137	2	REC321466	2
65 C	1986-89	REC330137	2	REC342786	1
				REC321466	1
	1974-85	REC330137	2	REC321466	2
70 (L)	1986-95	REC330137	2	REC342786	1
				REC321466	1
70 (S)	1977-85	REC321467	2	REC321466	2
	1975-84	REC330137	2	REC321466	2
75 (L)	1986-87	REC330137	2	REC342786	1
				REC321466	1
75 (S)	1975-84	REC321467	2	REC321466	2
85	1969-70		2	REC321466	2
85	1971-72	REC330137	2	REC321466	2
85	1973-80	REC330137	2	REC26-69188	2
				REC329922	1
88	1987-94	REC330137	2	REC329922	1
90	1981-83	REC330137	2	REC26-69188	2
				REC329922	1
90	1984-94	REC330137	2	REC329922	1
90 Seadrive	1985-90	REC330137	2	REC329922	1
				REC329922	1
100	1971-72	REC330137	2	REC321466	2
100	1979-80	REC330137	2	REC26-69188	2
				REC329922	1
100 C	1984-90	REC26-76868	2	REC329922	1
				REC329922	1
110	1986-88	REC330137	2	REC329922	1
				REC321466	2
115	1969-70		2	REC321466	2
115	1973-83	REC330137	2	REC26-69188	2
				REC329922	1
115	1984-85	REC330137	2	REC329922	1
				REC329922	1
115	1990-94	REC330137	2	REC329922	1
				REC329922	1
120	1985	REC26-76868	2	REC329922	1
				REC329922	1
120	1986-88	REC330137	2	REC329922	1
				REC329922	1
120	1989	REC26-76868	2	REC329922	1
				REC329922	1
120	1990-94	REC330137	2	REC329922	1
				REC329922	1
125	1971-72	REC330137	2	REC321466	2
				REC329922	1
125 C	1989	REC26-76868	2	REC329922	1
				REC329922	1
125 C (ESX)	1989	REC330137	2	REC329922	1
135	1973-76	REC330137	2	REC26-69188	2
140	1977-83	REC330137	2	REC26-69188	2
140	1984	REC330137	2	REC26-69188	2
				REC329922	1
140	1985	REC26-76868	2	REC329922	1
				REC329922	1
140	1986-94	REC330137	2	REC329922	1
				REC329922	1
140 TX	1989	REC26-76868	1	REC329922	1
				REC26-69188	2
150	1978-83	REC26-76868	2	REC329922	1
				REC329922	1
150	1984	REC26-76868	2	REC329922	1
				REC329922	1
155 C	1984-85	REC26-76868	2	REC329922	1
				REC329922	1
155 C	1986-90	REC26-76868	2	REC329922	1
				REC329922	1
175	1977-85	REC26-76868	2	REC26-69188	2
				REC329922	1
175	1986-90	REC26-76868	2	REC329922	1
				REC329922	1
185	1984-85	REC26-43035	2	REC329922	1
				REC329922	1
185	1990	REC26-76868	2	REC329922	1
				REC329922	1
200	1976-83	REC26-76868	2	REC26-69188	2
				REC329922	1
200	1984-85	REC26-76868	2	REC329922	1
				REC329922	1
200, 225	1986-90	REC26-76868	2	REC329922	1
				REC329922	1
235	1978-83	REC26-76868	2	REC26-69188	2
				REC329922	1
235	1984-85	REC26-76868	2	REC329922	1
				REC329922	1
275	1985-88	REC26-76868	2	REC329922	1
				REC329922	1
3.6L, 300	1985-90	REC26-76868	2	REC329922	1

AROS TÓRICOS

REF	OEM	Ø INT. (")	ANCHO WIDTH
REC25-48171	202893	0.370	0.065
REC25-33145	302337	2.025	0.135
REC125017	302540	1.000	0.135
REC302588	302588	1.735	0.135
REC3852045	303067 329381	0.360	0.100
REC25-62702	303191	0.301	0.070
REC303347	303347	0.445	0.090
REC25-35027	303360	1.060	0.135
REC305242	305242	0.300	0.135
REC308876	308876	2.235	0.100



O-RING

REF	OEM	Ø INT. (")	ANCHO WIDTH
REC310414	310414	3.625	0.135
REC25-30613	310585 310967	0.740	0.100
REC967344	313446	3.315	0.135
REC338518	313893 338518	2.550	0.100
REC318372	318372	0.320	0.155
REC0319662	319662	1.799	0.103
REC0554545	554545	1.120	0.100
REC908194	908194	4.000	0.100
REC25-25439	3852565	0.862	0.103



BOMBA DE AGUA

WATER PUMP

CUERPO BOMBA DE AGUA

HOUSING, WATER PUMP

REF	OEM		2T STROKES	4T STROKES
REC17411-93901	5033107	J10 / J15 (2002-06)		✓



REF	OEM		2T STROKES	4T STROKES
REC17411-94421	5031990	E25 / E30 J25 / J30 (2002-07)		✓



REF	OEM		2T STROKES	4T STROKES
REC389577	389577	4 - 8 HP	✓	✓



REF	OEM		2T STROKES	4T STROKES
REC393632	393632	20, 25, 35 HP		✓

Con casquillo de bronce. Escape a través de la hélice.  
W/ brass bushing. w/ Thru-Prop Exhaust.



REF	OEM	
REC384087	384087	2 Cyl. Loopcharged



REF	OEM	
REC983298	0983298 983298	100 - 260 (1962-85) COBRA



REF	OEM
REC330560	0330560 330560



JUNTA BASE DE BOMBA

WATER PUMP, GASKET BASE

REF	OEM		2T STROKES	4T STROKES
REC17472-97J00	5037432	JZR4		✓



REF	OEM		2T STROKES	4T STROKES
REC17472-87E10	5030725	J/BJ 90, 115, 140 HP		✓



REF	OEM		2T STROKES	4T STROKES
REC17472-96303	5036681 BJ 5031419 J25, 30 J/BJ 40-50 HP			✓





JUNTA TÓRICA  
BOMBA DE AGUA

WATER PUMP, O-RING

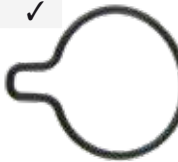
REF	OEM		2T STROKES	4T STROKES
REC17417-92J00	5037175	J/BJ 90, 115, 140 HP	✓	✓



REF	OEM		2T STROKES	4T STROKES
REC17416-95J00	5036901	J/BJ 25	✓	✓





REF	OEM		2T STROKES	4T STROKES
REC17416-93J00	5035039	J/BJ 200, 225 HP	✓	✓





CASQUILLO INOX

SS SLINGER

REF	OEM		2T STROKES	4T STROKES
REC324641	324641	4-8 HP	✓	✓





REF	OEM		2T STROKES	4T STROKES
REC338486	338486	V4, V6 & V8	✓	✓





REF	OEM		2T STROKES	4T STROKES
REC17413-95J00	5036900	J/BJ 25 HP	✓	✓





REF	OEM		2T STROKES	4T STROKES
REC17413-92J01	50367173	J/BJ 90, 115, 140 HP	✓	✓





REF	OEM		2T STROKES	4T STROKES
REC56130-94413-0EP	5032802	J/BJ 40, 50 HP	✓	✓



REF	OEM		2 Cyl. Loopcharged
REC320775	320775 +, 320776		



REF	OEM	
REC328751	328751	18 HP 2 Cyl., 35 HP 2 Cyl., Crossflow 3 Cyl



REF	OEM
REC320776	320776



CASQUILLO

SLINGER

REF	OEM
REC315837	0315837 315837



REF	OEM
REC912157	912157



GRUESO TUBO

TUBE GROMMET

REF	OEM
REC320943	0320943 320943



REF	OEM
REC321008	0321008 321008



REF	OEM
REC305762	0305762 0320936 0396355 305762



PLACA IMPULSOR

IMPELLER PLATE

REF	OEM	2T STROKES	4T STROKES
REC17471-97J00	5037431	J2 HP	✓



REF	OEM	2T STROKES	4T STROKES
REC17471-94401	5031418	E25, E30, E40 J25, J30, J40, J50 BJ40, BJ50 (1999-07)	✓



REF	OEM	2T STROKES	4T STROKES
REC17471-98601	5031196 5030189	J5 HP	✓



REF	OEM	2T STROKES	4T STROKES
REC17471-92J00	5034651 5037170 5030724	J/BJ 140, 90, 115	✓



REF	OEM	2T STROKES	4T STROKES
REC17471-93902	5033114	J10 / J15 (2002-07)	✓



REF	OEM	2T STROKES	4T STROKES
REC17471-92J02	5035041	J/BJ 225, 200 HP	✓



REF	OEM	2T STROKES	4T STROKES
REC17471-95J01	5036902	J/BJ 25 HP	✓



REF	OEM
REC338485	321188 338485 435027



REF	OEM
REC320981	0320981 320981



REF	OEM
REC320981	0320981 320981



CIRCLIP,  
BOMBA DE AGUA

CLIP

REF	OEM	
REC09380-15001	5033027	J10, 15 HP



PLACA DE LA BOMBA

PUMP PLATE

REF	OEM
REC303339	802208 0303339



JUNTAS BOMBA

WATER PUMP GASKETS

REF	OEM		2T STROKES	4T STROKES
REC17472-98611	5030190	E5 / J5 (1998)	✓	



REF	OEM		2T STROKES	4T STROKES
REC55122-94400	5031535	J40 / E40 / BJ40 J50 / E50 / BJ50 (1999-06)		✓



REF	OEM		2T STROKES	4T STROKES
REC17472-91J00	5033381	J14 / J5 / J6 (2003-07)		✓



REF	OEM		2T STROKES	4T STROKES
REC17472-93J00	5035042	J200 / J225 BJ200 / BJ225 (2004-06)		✓



REF	OEM		2T STROKES	4T STROKES
REC17452-93910	5033110	J10 / J15 (2002-07)		✓



REF	OEM		2T STROKES	4T STROKES
REC17472-93911	5035603	J10 / J15 (2004-07)		✓



DIAFRAGMA

DIAPHRAGM

REF	OEM	
REC435957	321692	2 Cyl, 3 Cyl V4 Loopcharged



**KITS DE REPARACIÓN  
BOMBA DE AGUA**

**WATER PUMP  
SERVICE KITS**

REF	OEM	STROKES	2T	4T
REC17400-98661	5034323	J4 / J5 / J6 (2005-07)	✓	✓

REF	OEM	STROKES	2T	4T
REC394711	394711	9.9, 15 HP (1974+) (1994+)	✓	✓

REF	OEM	STROKES	2T	4T
REC17400-98652	5030352	E4 / E5 J4 / J5 (1998-04)	✓	✓

REF	OEM	STROKES	2T	4T
REC17400-93951	5033106	J10 / J15 (2002-06)		✓

REF	OEM	STROKES	2T	4T
REC17400-94J00	5037545	J10, 15 HP		✓

REF	OEM	STROKES	2T	4T
REC17400-95J02	5036908	J/BJ 25 HP		✓

REF	OEM	STROKES	2T	4T
REC439077	0390770 0439077 390770 439077	2 Cyl. (1984-94), 3 Cyl. Loopcharged		

REF	OEM	STROKES	2T	4T
REC395270	0395270 395270	18 HP 2-Cyl. (1979-98), 25 HP 2-Cyl. (1979-98), 28 HP 2-Cyl. (1979-98)		

REF	OEM	STROKES	2T	4T
REC393630	393630	20-35 HP 2 Cyl. (1980-05)	✓	

Crossflow con escape a través de la hélice y cola de una pieza  
Crossflow with thru-prop exhaust and one-piece gearcase.

REF	OEM	STROKES	2T	4T
REC25700-95D01	5032167 5036040	E25 / J25 / E30 / J30 (2000-07)		✓

REF	OEM		2T STROKES	4T STROKES
REC432955	432955		✓	

65, 70 Et 75 HP 3 Cyl. (1986-01)

Loopcharged con cola larga. Bomba de agua grande con chaveta de impulsor de plástico.  
Loopcharged large gearcase. Large water pump with plastic wedge key impeller.

REF	OEM		2T STROKES	4T STROKES
REC17400-92J00	5037176			✓

J/BJ 90, 115, 140 HP

REF	OEM		2T STROKES	4T STROKES
REC5001594	5001594		✓	

V4/V6/V8

V4/V6/V8 con eje 20" (1979-06) Chaveta impulsor de plástico  
V4/V6/V8 with 20" shaft (1979-06) Plastic wedge key impeller.

REF	OEM		2T STROKES	4T STROKES
REC17400-90J20	5033541			✓

J90 / J115 / J140  
BJ90 / BJ118 / BJ140  
(2003-06)

REF	OEM		2T STROKES	4T STROKES
REC5001595	5001595		✓	

V4/V6/V8 (1979-06)

Con ejes de 25 y 30". Es el mismo kit que el REC5001594 pero con un agujero en el cuerpo de la bomba para refrigeración extra. Chaveta impulsor de plástico.  
With 25" and 30" shaft. Same water pump kit as REC5001594 except with a spray hole in pump housing for extra cooling of the long shaft exhaust housings.  
Plastic wedge key impeller.

REF	OEM		2T STROKES	4T STROKES
REC17400-93J01	5035036			✓

J200 / J225  
BJ200 / BJ225 (2004-06)

REF	OEM		2T STROKES	4T STROKES
REC17400-96403	5031744			✓

E40 / J40  
E50 / J50 (2000-02)

REF	OEM		2T STROKES	4T STROKES
REC17400-87E04	5031731			✓

E70 (1999-00)





TORNILLO BOMBA AGUA

SCREW

REF	OEM	
REC302325	0302325	
	0319126	
	302325	
	302873	
	324960	
REC331980	0331980	
	324430	
	331980	

## GUÍA BOMBAS DE AGUA

## WATER PUMP GUIDE

2T STROKES	4T STROKES	EJE SHAFT			KIT COMPLETO FULL KIT	2T STROKES	4T STROKES	EJE SHAFT			KIT COMPLETO FULL KIT
<b>1.5 HP - 15 HP</b>						120		20"	1985-94	REC338486	REC5001594
3,4		1991-96	REC324641			120		25"	1985-94	REC338486	REC5001595
4 (90)		1981-90	REC324641			130		20"	1995-98	REC338486	REC5001594
4 Deluxe		1985-88	REC324641	REC389577		130		25"	1995-98	REC338486	REC5001595
4 Deluxe		1989-96	REC324641			135		20"	2000-06	REC338486	REC5001594
4.5		1980-84	REC324641	REC389577		135		25"	2000-06	REC338486	REC5001595
5		1986-90	REC324641	REC389577		140		1977-78	REC338486		
5	✓	-1998	REC324641	REC389577		140		1979-84	REC338486		REC5001594
6		1984-96	REC324641	REC389577		140		20"	1985-94	REC338486	REC5001594
6	✓	-1998	REC324641	REC389577		140		25"	1985-94	REC338486	REC5001595
7.5		1980-83	REC324641	REC389577		<b>V6</b>					
8		1984-96	REC324641	REC389577		150		1978	REC338486		
8	✓	-1995			REC394711	150		1979-92	REC338486		REC5001594
9.9	✓	1974-96			REC394711	150		20"	1993-06	REC338486	REC5001594
9.9	✓	1995-01			REC394711	150		25"	1993-06	REC338486	REC5001595
15	✓	1974-96			REC394711	175		1977-78	REC338486		
15	✓	1995-01			REC394711	175		1979-92	REC338486		REC5001594
<b>18 - 40 HP 2 Cyl. Crossflow (a través de hélice   Thru-Prop)</b>						175		20"	1993-06	REC338486	REC5001594
20		1985-98		REC393632	REC393630	175		25"	1993-06	REC338486	REC5001595
25		1985-05		REC393632	REC393630	185		1984-92	REC338486		REC5001594
35		1980-96		REC393632	REC393630	185		20"	1993-94	REC338486	REC5001594
<b>3 Cyl.</b>						185		25"	1993-94	REC338486	REC5001595
60		1989-01			REC432955	200		1976-78	REC338486		
60	✓	1998+			REC432955	200		1979-92	REC338486		REC5001594
65		1979-01			REC432955	200		20"	1993-06	REC338486	REC5001594
70		1979-94			REC432955	200		25"	1993-06	REC338486	REC5001595
70	✓	1998+			REC432955	200		30"	1993-06	REC338486	REC5001595
75		1979-88			REC432955	225		1986-92	REC338486		REC5001594
<b>V4</b>						225		20"	1993-06	REC338486	REC5001594
85		25" 1977	REC338486			225		25"	1993-06	REC338486	REC5001595
85		1978	REC338486			235		30"	1978	REC338486	
85		1979-80	REC338486		REC5001594	235		1979-85	REC338486		REC5001594
90		1981-94	REC338486		REC5001594	250		20"	2006	REC338486	REC5001594
90		20" 1995-03	REC338486		REC5001594	250		25"	2006	REC338486	REC5001595
90		25" 1995-03	REC338486		REC5001595	<b>V8</b>					
100		1979-80	REC338486			250		1991-92	REC338486		REC5001594
100		1984-97	REC338486		REC5001594	250		20"	1993-98	REC338486	REC5001594
100		20" 1998-05	REC338486		REC5001594	250		25"	1993-98	REC338486	REC5001595
100		25" 1998-05	REC338486		REC5001595	250		30"	1993-98	REC338486	REC5001595
105		1998-01	REC338486		REC5001595	275		1985-88	REC338486		REC5001594
115		25" 1977	REC338486			300		1985-92	REC338486		REC5001594
115		1978	REC338486			300		20"	1993-95	REC338486	REC5001594
115		1979-94	REC338486		REC5001594	300		25"	1993-95	REC338486	REC5001594
115		20" 1995-06	REC338486		REC5001594	300		30"	1993-95	REC338486	REC5001595
115		25" 1995-06	REC338486		REC5001595						

## TORNILLO DRENAJE

## DRAIN SCREW

REF	OEM	
REC309243	0309243 309243	
REC324334	0324334 324334	



# ANODOS

# ANODES



## ÁNODO



## ANODE

REF	OEM	 (kg)	
ZN REC432397	432397	0,08	
AL REC432397AL		0,04	

REF	OEM	 (kg)	
ZN REC392462	392462	0,71	
AL REC392462AL		0,13	



REF	OEM	 (kg)	
ZN REC433458	433458	0,33	
AL REC433458AL		0,13	



REF	OEM	 (kg)	
ZN REC173029	173029	0,07	
AL REC173029AL		0,03	



REF	OEM	 (kg)	
ZN REC5030267	5030267	0,10	
AL REC5030267A		0,04	



REF	OEM	 (kg)	
ZN REC355964	355964	0,24	
AL REC355964AL		0,12	

REF	OEM	 (kg)	
ZN REC5009220	5009220	0,54	
AL REC5009220AL		0,23	



REF	OEM	 (kg)	
ZN REC357507	357507		
AL REC357507AL			

REF	OEM	 (kg)	
ZN REC398873	398873	0,14	
AL REC398873AL		0,60	

REF	OEM	 (kg)	
ZN REC389999	389999	0,19	
AL REC389999AL		0,09	

REF	OEM	 (kg)	
ZN REC392123	392123	0,82	
AL REC392123AL		0,13	

REF	OEM	 (kg)	
ZN REC5007582	5007582	0,18	

REF	OEM	 (kg)	
ZN REC338635	338635	0,04	
AL REC338635AL		0,01	

REF	OEM	 (kg)	
ZN REC338742	338742	0,43	
AL REC338742AL		0,27	

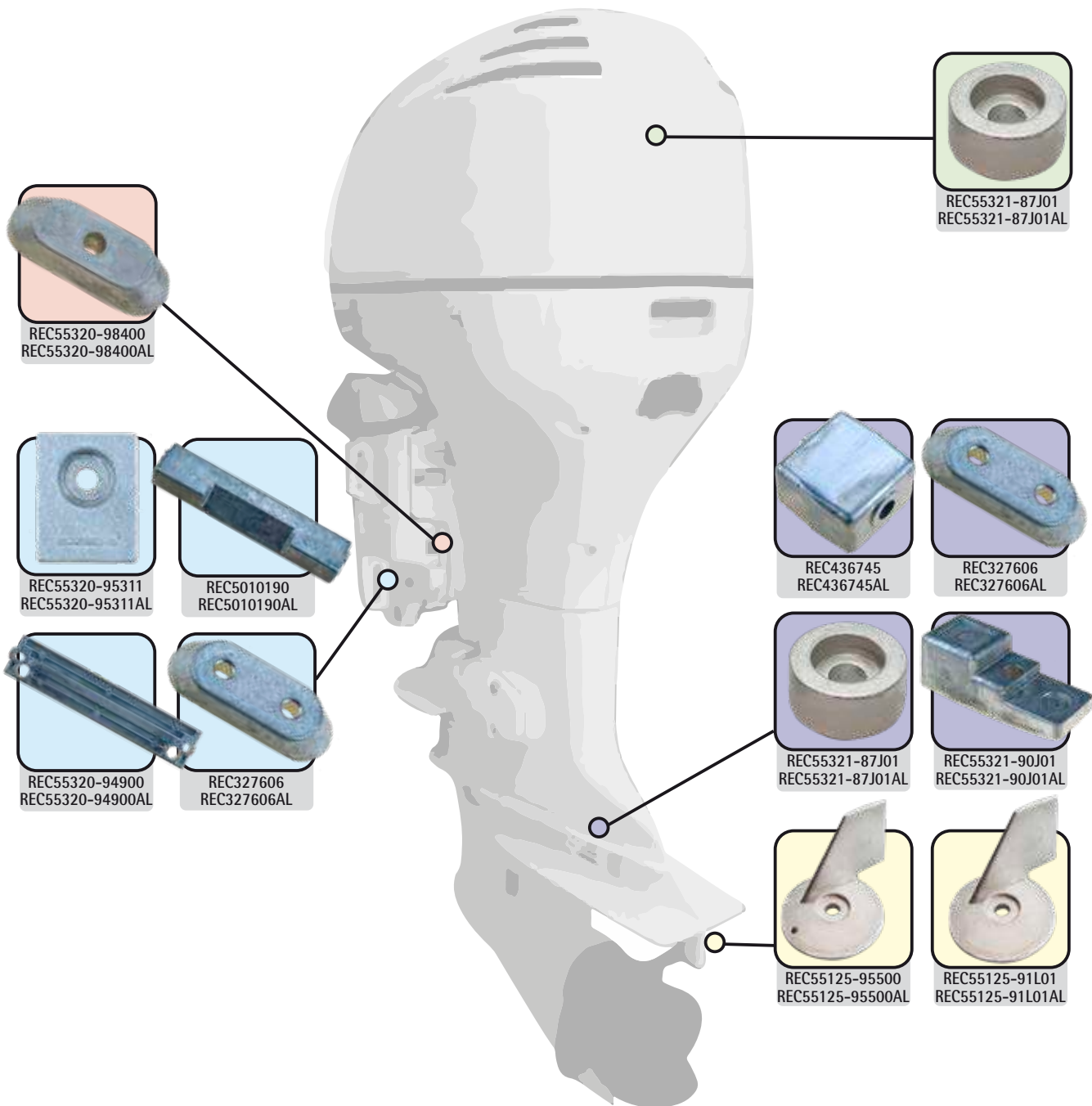

	MOTOR ENGINE	SOPORTE BRACKET	TRIM	COLA GEAR CASE	TRIM TAB
40HP +				REC436745 REC436745AL	
60 To 300HP (V4 & V6)		REC5010190 REC5010190AL			
1.2 TO 175HP		REC327606 REC327606AL		REC327606 REC327606AL	
40/50/70HP					REC55125-95500 REC55125-95500AL
5HP			REC55320-98400 REC55320-98400AL		
5 TO 225HP		REC55320-95311 REC55320-95311AL			
4/5/6HP				REC55321-87J01 REC55321-87J01AL	
40 TO 250HP	REC55321-87J01 REC55321-87J01AL				
60 TO 225HP		REC55320-94900 REC55320-94900AL			
25/30HP					REC55125-91L01 REC55125-91L01AL
60/70/90/115HP				REC55321-90J01 REC55321-90J01AL	

KITS

REF	
AL	RECKITOMC50-75AL
MG	RECKITOMC50-75M
ZN	RECKITOMC50-75ZN



REF	
AL	RECKITOMCV4-V6AL
MG	RECKITOMCV4-V6M
ZN	RECKITOMCV4-V6ZN



JUNTA TÓRICA

O-RING

REF	OEM	ÁNODO ANODE
REC09280-22019	5035305	55321-87J00



JUNTA TAPA DEL ÁNODO

GASKET, ANODE COVER

REF	OEM
REC11265-87E10	5030623



TORNILLO INOX

SS SCREW

REF	OEM	ÁNODO ANODE
PAGB/T5783-M6X14	5036691	55321-87J00



REF	OEM	ÁNODO ANODE	
REC09116-06094	5030034	55321-93J00	6 X 15
	5030035		
	5030036		
REC09116-06121	5030391	55321-94900	6 X 25
	5032502		



REF	OEM
REC306643	0306643 306643



REF	OEM
REC328725	0328725 328725



# PARTES DEL MOTOR

# ENGINE PARTS

DESPIECE MOTOR  
4 TIEMPOS

ENGINE PARTS  
4 STROKES

4T J/BJ 40, 50 HP  
STROKES

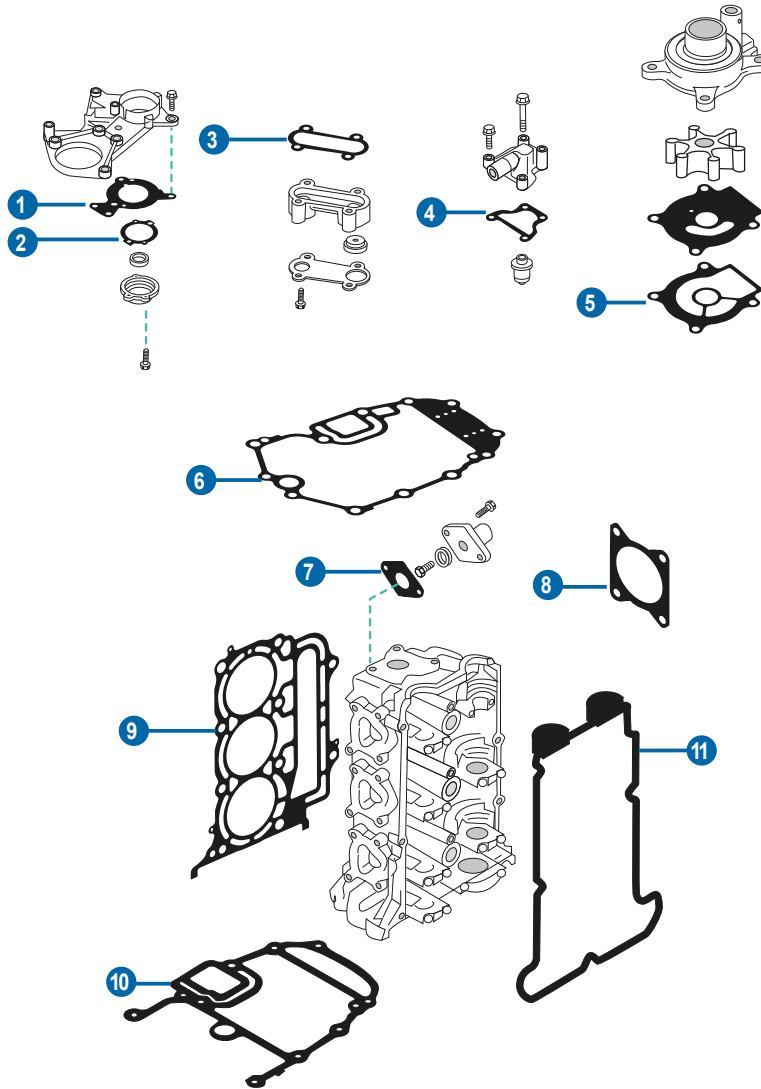

	REF	OEM		
1	REC11413-87J00	5031304	RETÉN SUPERIOR	SEAL UPPER
2	REC11433-87J00	5031306	JUNTA DEL RETÉN SUPERIOR	SEAL UPPER, GASKET
3	REC17616-87J00	5031426	JUNTA DE LA VÁLVULA DE PRESIÓN	PRESURE VALVE, GASKET
4	REC17685-87D10	5031430	JUNTA TAPA DE TERMOSTATO	THERMOSTAT COVER GASKET
5	REC17472-96303	5036681	JUNTA DE LA BOMBA DE AGUA	WATER PUMP, GASKET
6	REC11489-87J00	5031307	JUNTA DEL CÁRTER	OIL PAN, GASKET
7	REC11265-87E10	5030623	JUNTA TAPA DEL ÁNODO	GASKET, COVER ANODE
8	REC13421-87J00	5031390	JUNTA DEL CUERPO DE MARIPOSA	THRPOTTLE BODY GASKET
9	REC11141-87J02	5031293	JUNTA DE CULATA	CYLINDER HEAD, GASKET
10	REC51211-87J00	5031523	JUNTA BASE MOTOR	GASKET ENGINE
11	REC11189-87J00	5031297	JUNTA TAPA DE BALANCÍN	GASKET CYLINDER COVER

**JUNTAS DE MOTOR  
4 TIEMPOS**

**ENGINE GASKET  
4 STROKES**

**4T**  
STROKES

**JUNTAS DE CULATA**

**CYLINDER HEAD GASKET**

REF	OEM	
REC11141-97J02	5037490	2 HP



REF	OEM	
REC11141-87J02	5031293 5034353	J/BJ 40, 50 HP

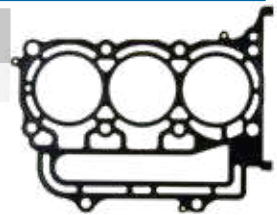

REF	OEM	
REC11141-91JL0	5033342	J4, 5, 6 HP



REF	OEM	
REC11141-90J01	5033639	90 & 115 HP

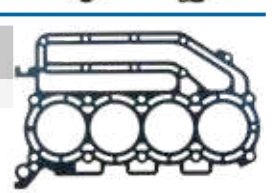

REF	OEM	
REC11141-95J00	5036802	25 HP



REF	OEM	
REC11141-92J01	5034644	140 HP

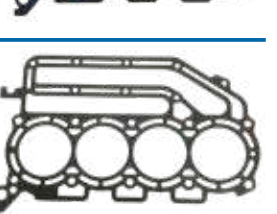

REF	OEM	
REC11141-93E20	5033046	9.9 & 15 HP



REF	OEM	
REC11142-93J10	5035971	200 & 225 HP PORT
REC11141-93J10	5036629	200 & 225 HP STB



**KITS  
JUNTAS DE CULATA**

**CYLINDER HEAD GASKET  
KIT**

**4T**  
STROKES

REF	OEM	
REC11400-87804	5034354 5036714 5031302	BJ, J40, J50HP

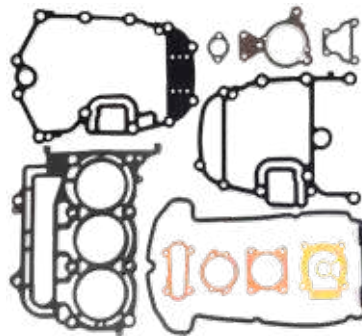

**JUNTA TAPA DE BALANCINES**

**GASKET, CYLINDER COVER**

**4T**  
STROKES

REF	OEM	
REC11189-87J00	5031297	J/BJ 40, 50 HP



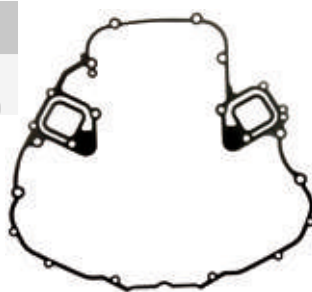

**4T**  
STROKES**JUNTAS BASE DE MOTOR****CYLINDER GASKET**

REF	OEM	
REC51211-93J00	5035138	J/BJ200 J/BJ225 (2004-06)

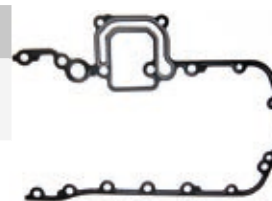

REF	OEM	
REC51211-90J10	5034757	J/BJ90 J/BJ115 J/BJ140 (2004-06)



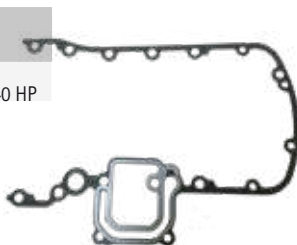

REF	OEM	
REC51211-90J2	5037205	J, BJ 90, 115, 140 HP

Motores modernos  
New engines

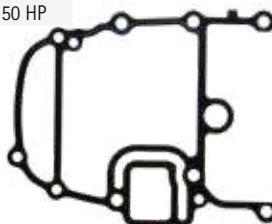

REF	OEM	
REC51211-87J00	5031523	J, BJ40, BJ50 HP

**4T**  
STROKES**JUNTA TAPA DE TERMOSTATO****GASKET, THERMOSTAT COVER**

REF	OEM	
REC17685-87D10	5031430	J/BJ 40, 50 HP

**4T**  
STROKES**JUNTA VÁLVULA DE PRESIÓN****GASKET, PRESSURE VALVE**

REF	OEM	
REC17616-87J00	5031426	J/BJ 40, 50 HP

**4T**  
STROKES**JUNTA RETÉN SUPERIOR****GASKET, UPPER SEAL**

REF	OEM	
REC11413-87J00	5031304 5032428	J/BJ 40, 50 HP



REF	OEM	
REC11433-87J00	5031306	J/BJ 40, 50 HP

**JUNTA TAPA SELECTOR****COVER SELECTOR GASKET**

REF	OEM
REC314082	0314082 314082



JUNTAS CUERPO DE MARIPOSA

GASKET,  
THROTTLE BODY

REF	OEM	
REC13421-87J00	5031390	J/BJ 40, 50 HP

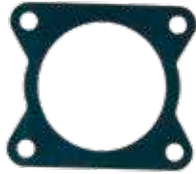

CIGÜEÑAL

CRANKSHAFT

BIELAS

CONNECTING ROD

REF	OEM	
REC394462	394462	40 HP (1999-01) 50 HP (1995-98) 60 HP (1989-01) 70 HP (1986-01)



REF	OEM	
REC395861	395861	30 HP (1999-01) 40 HP (1985-02) 45 HP (1986-87, 1990-97) 48 HP (1987-96) 50 HP (1985-02) 55 HP (1985-96, 1999-01) 60 HP (1985)



RETENES

OIL SEALS

REF	OEM	
REC398051	398051	20, 35 HP (1976-05)



REF	OEM	
REC328603	328603	20, 35 HP CROSSFLOW (1985-05)



GUÍA RETENES

CRANKSHAFT GUIDE

		1	2
18	1957	REC321467	1
40	1974-76	REC321895	1
40 C	1981-86	REC321895	1
40	1984-85	REC321895	1
40 (AR,AE,AT)	1988	REC321895	1
40	1986-89	REC321895	1
45 C	1985-95	REC321895	1
48	1988-95	REC321895	1
50	1971-80	REC321895	1
50/60	1981-89	REC321895	1
50	1990-95	REC321895	1
55	1968-69	REC321895	1
55, 55 C	1976-85	REC321895	1
55 C	1986-95	REC321895	1
60	1970	REC321895	1
60 (3-Cyl.)	1971	REC321895	1
60	1980-83	REC321895	1
60 SST	1989	REC321895	1
60 SST	1990	REC321895	1
60 (3-Cyl.)	1987-95	REC321895	1
65 (Manual)	1968	REC321895	1
65 (3-Cyl.)	1972-73	REC321895	1
65 C	1984-89	REC321895	1
70 (Large)	1974-85	REC321895	1

		1	2
70 (Large)	1986-95	REC321895	1
70 (Small)	1977-85	REC321895	1
75 (Large)	1975-87	REC321895	1
75 (Small)	1975-84	REC321895	1
85	1969-72	REC321895	1
85	1973-80	REC321895	2
90	1981-83	REC321895	2
90	1984-94	REC329923	1
90 Seadrive	1985-90	REC321895	2
100	1971-72	REC321895	1
100	1979-80	REC321895	2
110	1986-88	REC321895	2
115	1969-83	REC321895	1
115	1984-85	REC321895	2
125	1971-72	REC321895	1
125 C (ESX)	1989	REC329923	1
135	1973-76	REC321895	2
140	1977-84	REC321895	2
155 C	1984-85	REC321895	2
175	1977-85	REC321895	2
185	1984-85	REC321895	2
200	1976-83	REC321895	2
235	1978-85	REC321895	2

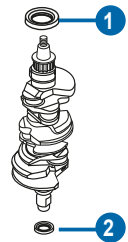

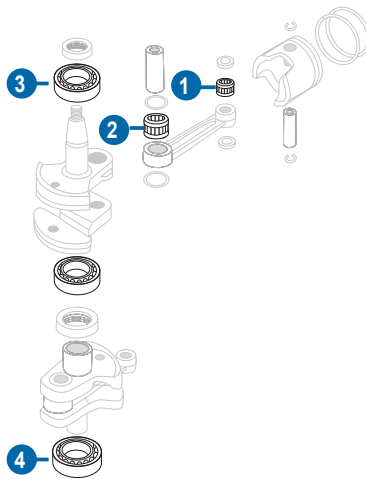



## 1 COJINETES PIE DE BIELA

## CONNECTING ROD BEARING, SMALL END

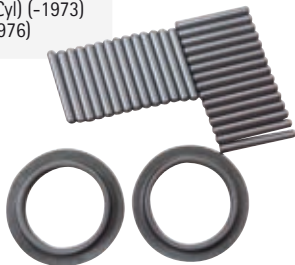
REF	OEM	
REC395627	395627	20 - 35 HP (1981-95) 45 - 60 (2 Cyl) (1977-95) V4 Crossflow (3 Cyl) (-1973) V6 Crossflow (-1976) V4, V6 60°



REF	OEM	
REC434844	434844	V4, V6, V8 90° LoopedCharged (1985+)



## 2 COJINETES CABEZA DE BIELA

## CONNECTING ROD BEARING, BIG END

REF	OEM	
REC31-17514A2	437088	20 - 35 HP (1976-95) 46 - 60 HP (2 Cyl) (1971-94) 3 Cyl (1968-93) V4 (1961-73)    Ø 1.1825 - 30 mm



REF	OEM	
REC878763	396041	V4, V6, V8 90° LoopedCharged (1985-95)    Ø 1.500



REF	OEM
REC388344	388344



## 3 COJINETES SUPERIORES

## UPPER BEARING

REF	OEM	
REC398529	398529	45 - 60 HP (Modernos   Late models) 2 Et 3 Cyl



## 4 COJINETES INFERIORES

## LOWER BEARING

REF	OEM	
REC377139	377139	3 Cyl (1968-94)



## GUÍA COJINETES

## GUIDE BEARING

		1	2	3	4
9.9	1974-83	REC395627			
9.9	1984-97	REC395627			
10	1981	REC395627			
14 COM	1989-91	REC395627			
15	1974-83	REC395627			
15	1984-97	REC395627			
15 COM	1994	REC395627			
18	1970-73	REC395627			
18 JET	1996-97	REC395627	REC388344		
20	1981-84	REC395627	REC388344		
20	1985-97		REC388344		
25	1977	REC395627	REC388344		
25	1978-80	REC395627	REC388344		
25	1981-84		REC388344		
25 (NO mod. D)	1985-97		REC388344		
25 COM	1982-84		REC388344		
25 COM	1985-97	REC395627	REC388344		
28	1987-97	REC395627	REC388344		
30	1984		REC388344		
30	1985-97		REC388344		
33	1970		REC388344		
35	1976-80	REC395627	REC388344		
35	1981-84	REC395627	REC388344		
35	1985-97	REC395627	REC388344		
40	1971-73	REC395627	REC388344		
40	1974-76 1983	REC395627	REC388344		REC377139
40	1984-86	REC395627	REC388344		REC377139
40	1987-97	REC395627	REC388344	REC398529	REC377139
40 COM	1982-83	REC395627	REC388344		REC377139
40 COM	1984-85	REC395627	REC388344		REC377139
40 COM	1989-90	REC395627	REC388344	REC398529	REC377139
40 COM	1994	REC395627	REC388344	REC398529	
40 COM	1995-00	REC395627		REC398529	
45 COM	1985-86 1987-94	REC395627	REC388344		REC377139
45 COM	1995-97	REC395627		REC398529	
45 SS	1987-90	REC395627	REC388344		REC377139
48	1987	REC395627	REC388344		REC377139
48	1988-96	REC395627	REC388344	REC398529	REC377139
50	1979-83	REC395627	REC388344		REC377139
50	1984-86	REC395627	REC388344		REC377139
50 (2 Cyl)	1987-00	REC395627	REC388344	REC398529	REC377139
50 (3 Cyl)	1995-00	REC395627		REC398529	REC377139
55	1976-81		REC388344		REC377139
55 COM	1982	REC395627	REC388344		REC377139
55 COM	1983-86	REC395627	REC388344		REC377139
55 COM	1987-94	REC395627	REC388344	REC398529	REC377139
55 COM	1995-00	REC395627		REC398529	
60	1980-83		REC388344		REC377139
60	1984-85 1986-90	REC395627	REC388344		REC377139
60	1991-93	REC395627	REC388344	REC398529	REC377139
60	1994-01	REC395627		REC398529	REC377139
SST-60	1989-90		REC388344		REC377139
65	1972-73	REC395627	REC388344		REC377139
65 COM	1984	REC395627	REC388344		REC377139
65 COM	1985-90	REC395627	REC388344		REC377139

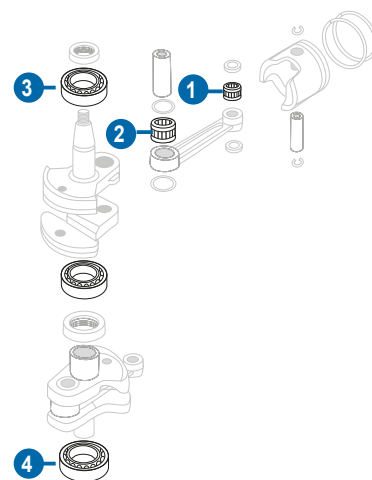

		1	2	3	4
65 COM	1991-93		REC388344	REC398529	
65 COM	1994-01	REC395627		REC398529	
70	1974-75 1976-84	REC395627	REC388344		REC377139
70	1985-90	REC395627	REC388344		REC377139
70	1991-93	REC395627	REC388344	REC398529	REC377139
70	1994-97	REC395627		REC398529	REC377139
75	1975		REC388344		REC377139
75	1976-84	REC395627	REC388344		REC377139
75	1985-88	REC395627	REC388344		REC377139
80 JET	1992-98	REC395627			
85	1968-72	REC395627	REC388344		REC377139
85	1973	REC395627	REC388344		
85	1974-78	REC395627			
85	1979-80 1991-95	REC395627			
88	1987-96	REC395627			
90 (60° V)	1995-03	REC395627			
90 JET	1994-95	REC434844			
100	1990-94	REC434844			
100 COM	1984-05	REC434844			
110	1986-89	REC434844			
115	1994-96	REC395627			
115	1974-78	REC395627			
115	1979-85	REC395627			
115 (90° V)	1990-06	REC434844			
115 (60° V)	1995-06	REC395627			
120	1985-94		REC878763		
125	1971-72	REC395627	REC388344		REC377139
125 COM	1989-95	REC395627	REC878763		
125 ESX	1991-94		REC878763		
130	1994-00	REC395627	REC878763		
135	1974-76	REC434844			
140	1977-78	REC395627			
140	1979-84	REC434844			
140	1985-94	REC434844	REC878763		
150	1978-91	REC434844			
150 (60° V)	1991-06	REC434844			
150 COM (60° V)	1993-95	REC395627			
155 COM	1984-92	REC434844			
175	1977-91	REC434844			
175 (60° V)	1991-97	REC434844			
185	1984-85	REC434844			
185	1990-94	REC434844	REC878763		
200	1986-06		REC878763		
200 COM	1990, 1994		REC878763		
225	1986-06		REC878763		
250	1991-95 1997		REC878763		
275	1985-88		REC878763		
3.6L	1985-87		REC878763		
300	1988-95		REC878763		



# PISTONES

# PISTONS

4T  
STROKES

STD (3.600")		STD 030 (3.630")		
REF	OEM	REF	OEM	
 REC5006728	5006728	REC5006730	5006730	75, 90, 115, 150, 175 HP 60° (2000+)





## SERIE FITCH

## KITS

## SETS

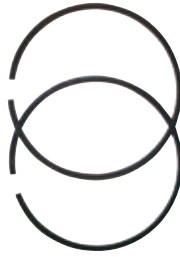

REF	OEM	
REC431870	431870	
		V4 120 HP 90° (1988-94) V4 140 HP 90° (1988-94) V6 200 HP (1988-92) V6 225 HP (1988-92) V8 275 HP (1991-98) V8 300 HP (1988-95) OCEAN PRO/RUNNER 90° 200 HP / 225 HP (1993-01) Con carburadores With carburators
REC436254	436254	3.685"
REC390509	390509	3.625"
		175 HP (1986-91) 235 HP (1980-85) V4 85 HP (1979-80) 88 HP (1987-93) 90 HP (1981-93) 100 HP (1984-94) 110 HP (1986-90) 115 HP (1973-85) 135 HP (1974-76) 140 HP (1977-84) 150 HP (1978-91) 175 HP (1977-85) 185 HP (1984-85) 200 HP (1976-83) 235 HP (1978-79) (2 Cyl)
REC394930	394930	3.500"
REC396377	396377	3.000"
		20 HP (1981-83) 25 HP (1986-94) 30 HP (1984-94)

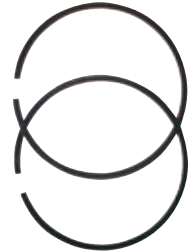

STD (2.188")		
REF	OEM	
 REC386918	386279	(2 Cyl) 9.9 HP (1981-92) 15 HP (1981-92)

## CROSSFLOW



STD (3.187")		
KIT REF	OEM	
REC435546	5006655	(2 Cyl) 40 HP (1984-94) 45 HP (1994) 48 HP (1987-94) 50 HP (1981-94) 55 HP (1994) 60 HP (1980-85)
 REC391170	391170	

## LOOPCHARGED



## JUNTAS DE MOTOR 2 TIEMPOS

## ENGINE GASKET 2 STROKES

2T  
STROKES

## JUNTAS DE CULATA

## CYLINDER HEAD GASKET

REF	OEM
REC313782	313782



REF	OEM
REC330818	330818



REF	OEM
REC329419	329419



REF	OEM
REC335359	335359 327795



REF	OEM
REC318358	318358



REF	OEM
REC338222	338222



REF	OEM
REC329103	329103



REF	OEM
REC203130	203130

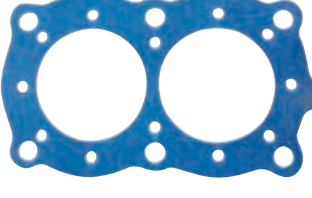

REF	OEM
REC802307	332010



REF	OEM
REC329836	329836



REF	OEM
REC802288	325273



**KITS  
JUNTAS DE CULATA**

**CYLINDER HEAD GASKET  
KIT**

REF	OEM	
REC802113	394546	9.9 - 15 HP (1984-92)

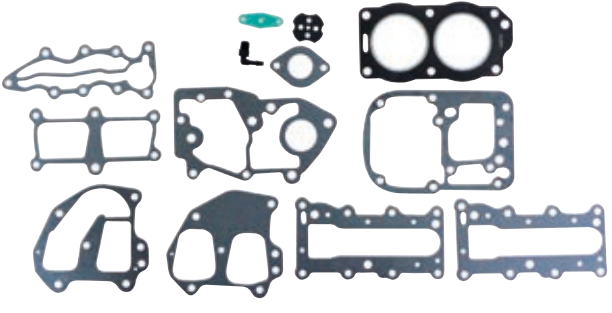

REF	OEM	
REC39390	398047 438904	60 - 70 HP (3 cyl) (1986-01)

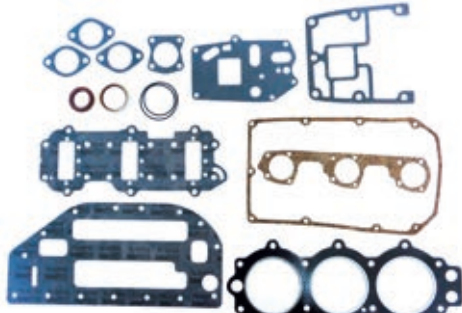

REF	OEM	
REC802133	433941 392567 392615	20 - 30 HP Crossflow (1996-99)



2T  
STROKES

**GUÍA  
JUNTAS DE CULATA**



			cyl	KIT	
2 Colt, Junior					REC313782
4					REC203130
2.5, 3, 4, 4.5, Ultra, Excel 4					REC802307
5, 5.5, 6					REC329103
6					REC802288
9.9, 15			2	REC802113	REC330818
9.9, 15			2		REC338222
20, 25, 28, 30			2	REC802133	
20, 25, 28, 30, 35 (521 cc)					REC329419
35			2	REC802133	
40, 45, 48, 50, 55, 60 (737 cc)					REC335359
50			3	REC39390	

**CYLINDER HEAD GASKET  
GUIDE**

			cyl	KIT	
60			-1989	3	REC39390
65			-1987	3	REC39390
70			-1986	3	REC39390
70 (814 cc)			1989-01	3	REC329836
70 (913 cc)			1986-01	3	REC329836
115, 135			1973		REC318358
<b>V4 CROSSFLOW</b>					
85, 88, 90, 100, 110, 115			1978-94		REC318358
115, 135, 140			1973-78	REC318358	REC318358
140			1977-84		REC318358

2T  
STROKES

**JUNTAS BASE DE MOTOR**

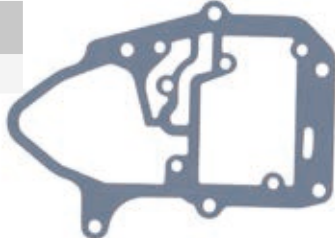
REF	OEM		
REC324717	324717		9.9 - 15 HP (1972-85)
			
REC325721	325721		9.9 - 15 HP (1986+)
			
REC0330621	330621		25, 35 HP (1979+)
			

**CYLINDER GASKET**

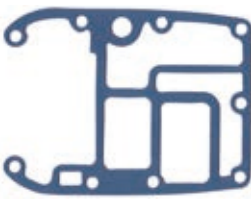
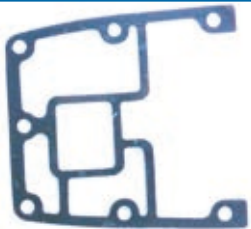
REF	OEM		
REC351018	351018		2 Cyl Loopcharged
			
REC329828	329828		3 cyl, 60, 70 HP
			

**JUNTA TAPA BYPASS**

REF	OEM		
REC307133	0307133 307133		90° V4
			

**BYPASS COVER GASKET**

**GUÍA  
CORREAS DE DISTRIBUCIÓN**

		REF	OEM
J10/J15 HP	69	REC12761-93E0	5033070
J/BJ 60, 70 HP	89	REC12761-72F00	5030660

**GUIDE  
TIMING BELT**



# SISTEMA DE ESCAPE Y ADMISION

# EXHAUST & INTAKE SYSTEM

## SISTEMA DE ESCAPE

## EXHAUST SYSTEM

### JUNTAS ESCAPE

REF	OEM	
REC802243	313065	5, 5.5, 6 HP

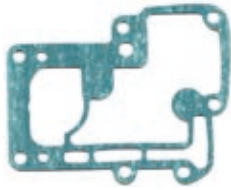

REF	OEM	
REC318925	318925	9.9, 15 HP



REF	OEM	
REC0324323	3234323	25, 35 HP

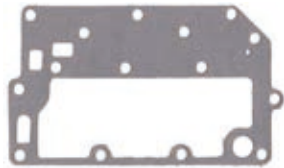

### GASKETS, EXHAUST

REF	OEM	
REC0326264	326264	2 Cyl Crossflow

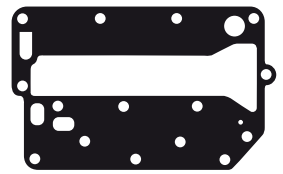

REF	OEM	
REC343863	343863	3 Cyl 60 - 70 HP



REF	OEM	
REC336308	336308	3 Cyl, 60, 70, HP (1986+)



### RETENES CUERPO DE ESCAPE

REF	OEM	
REC320936	320936	V4 - V6



REF	OEM	
REC324937	0324937 324937 5000309	40 HP, 75 HP



### SEALS - HOUSING EXHAUST

REF	OEM	
REC320961	320961	V4 - V6

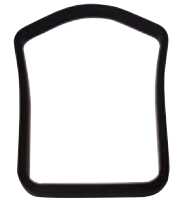

### JUNTAS DE CARTER

REF	OEM	
REC11489-90J00	5033649	J/BJ90 J/BJ115 J/BJ140 (2003-06)

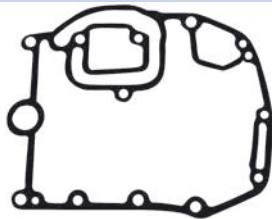



REF	OEM	
REC11489-87J00	5031307	J/BJ 40, 50HP

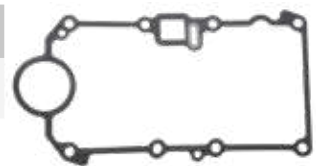

### OIL PAN GASKET

REF	OEM	
REC11489-93E11	5034462	J10 J15 (2004-07)



REF	OEM	
REC11489-93J00	5034878	J/BJ200 J/BJ225 (2004-06)

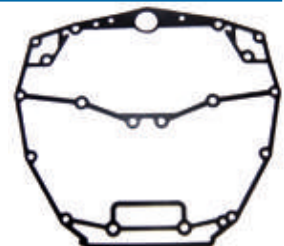

4T  
STROKES

SISTEMA DE ADMISIÓN

INTAKE SYSTEM

JUNTAS TAPA PASO AGUA BLOQUE

POWERHEAD WATER PASSAGE COVER GASKETS

REF	OEM	
REC327674	327674	25, 35 HP



REF	OEM	
REC329920	329920	9.9, 15 HP



JUNTAS TAPA TRANSFERENCIA BABOR MOTORES CROSSFLOW

CROSSFLOW ENGINE POWERHEAD TRANSFER PORT GASKET

REF	OEM	
REC319332	319332	9.9, 15 HP



REF	OEM	
REC0319661	319661	25, 35 HP

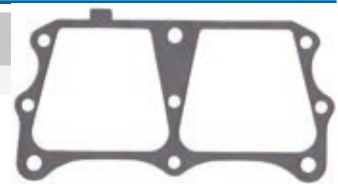

REF	OEM	
REC307133	0307133 307133	90° V4



JUNTAS DE CARBURADOR A COLECTOR ADMISIÓN

CARBURETOR TO INTAKE MANIFOLD GASKETS

REF	OEM	
REC325092	325092	20 - 75 (1980+)



REF	OEM	
REC326926	326926	3 Cyl



REF	OEM	
REC318932	318932	6 - 30 (1975+)



REF	OEM	
REC327707	327707	V4 / V6



JUNTAS BASE LENGÜETA

REED PLATE GASKETS

REF	OEM	
REC318924	318924	9.9, 15 HP



REF	OEM	
REC325260	325260	9.9, 15 HP



REF	OEM	
REC0321479	321479	25, 35 HP



REF	OEM	
REC0326260	326260	25, 35 HP



JUNTAS COLECTOR

GASKET, COLLECTOR

REF	OEM	
REC13119-93J00	5034959	J/BJ 200 J/BJ 225 (2004-06)





JUNTAS SILENCIADOR

REF	OEM		
REC321497	321497	40 - 60 HP	

REF	OEM		
REC333008	333008	3 Cyl	

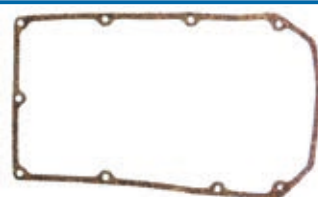
AIR SILENCER GALLERY

REF	OEM		
REC321794	3214794	3 Cyl	

REF	OEM		
REC323338	323338	25, 35 HP	

RETENES DE ACEITE

RETÉN DE ACEITE

REF	OEM		
REC09282-10008	5030107	E5 / J5 J4 / J6 (1998-07)	

REF	OEM		
REC09282-12010	5033011	J10 J15 (2002-07)	

REF	OEM		
REC09282-15008	5036938	J/BJ25 (2006-07)	

REF	OEM		
REC09282-17005	5031264	E40 / J40 / BJ40 E50 / J50 / BJ50 (1999-06)	

REF	OEM		
REC09283-10003	5030109	E5 / J5 (1998-01)	

REF	OEM		
REC09283-10009	5033339	J4 / J5 / J6 (2003-07)	

REF	OEM		
REC09289-20009	5031893	E25 / J25 / BJ25 E30 / J30 / BJ30 (2000-07)	

OIL SEALS

OIL SEAL

REF	OEM		
REC09282-12008	5030108	E5 / J5 J4 / J6 (1998-07)	

REF	OEM		
REC09282-17009	5031266	E25 / J 25 E40 / J40 E50 / J50 E30 / J50 (1999-07)	

REF	OEM		
REC09283-20018	5030110	E5 / J5 (1998-01)	

REF	OEM		
REC09283-20045	5030111	E5 / J5 (1998-01)	

REF	OEM		
REC09283-25076	5033481	J4 / J5 / J5 (2003-06)	

REF	OEM		
REC09289-17006	5033015	J10 J15 (2002-07)	

REF	OEM		
REC09289-22007	5031270	E40 / J40 / BJ40 E50 / J50 / BJ50 (1999-06)	

JUNTA TAPÓN DE DRENAJE

REF	OEM		
REC09168-10022	5030071	4 -140 HP	10 x 17 x 1.5 mm

O-RING DRAIN CAP



# UNIDADES DE TRANSMISIÓN UNIT DRIVES & COMPONENTS

## COLA

## GEARCASE ASSY

### 2 & 3 CYL. LOOPCHARGED

#### Cola pequeña estilo "antiguo" (1975-88)

Altura: 15-1/2"

Final de la aleta de cavitación afilado. Seis agujeros sobre la aleta de cavitación. Tomas internas de agua (cuatro agujeros). Sin tubo corredera.

#### Small Gearcase "Old" Style

(1975-88)

15-1/2" tall.

Pointed at the trailing end of the cavitation plate. Six holes above the cavitation plate. Internal water intake screens (four holes). No speedo pitot.

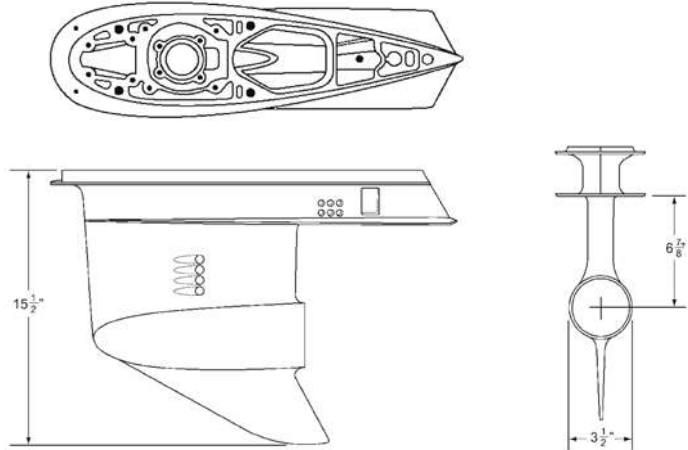

#### Cola pequeña estilo "moderno" (1989-05)

Altura: 15-3/5"

Final de la aleta de cavitación afilado. Seis agujeros sobre la aleta de cavitación. Tomas externas de agua. Con tubo corredera.

#### Small Gearcase "New" Style

(1989-05)

15-3/5" tall.

Pointed at the trailing end of the cavitation plate. Six holes above the cavitation plate. External water intake screens. Includes speedo pitot.

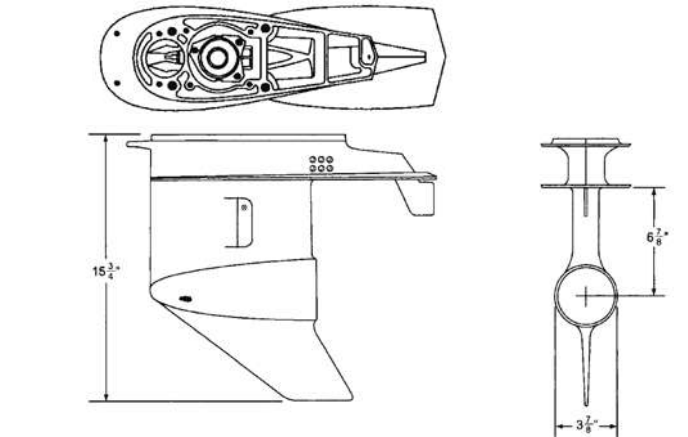

#### Cola larga (1975-06)

Altura: 17-7/16"

Final de la aleta de cavitación afilado. Seis agujeros sobre la aleta de cavitación. Tomas internas de agua (tres agujeros). Sin tubo corredera.

#### Large Gearcase (1975-06)

17-7/16" tall.

Pointed at the trailing end of the cavitation plate. Six holes above the cavitation plate. Internal water intake screens (three holes). No speedo pitot.

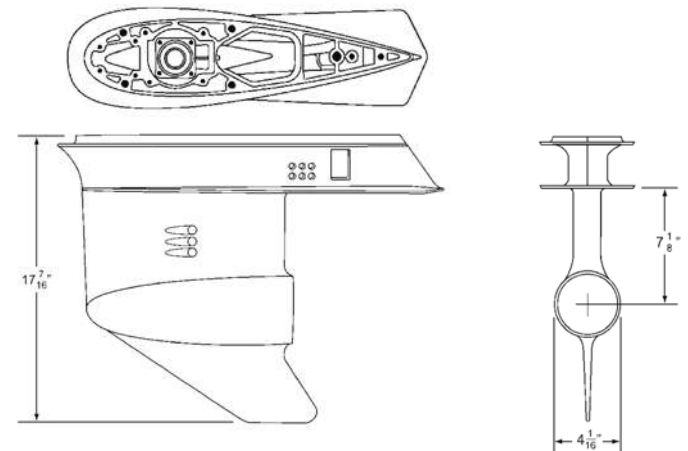

**V4 90°**

**Cola pequeña (1978-98)**

Altura: 18-3/16"  
 Final de la aleta de cavitación afilado  
 Seis agujeros sobre la aleta de cavitación  
 Tomas internas de agua (cuatro agujeros)  
 Sin tubo corredera

**Small Gearcase (1978-98)**

18-3/16" tall.  
 Pointed at the trailing end of the cavitation plate.  
 Six holes above the cavitation plate.  
 Internal water intake screens (four holes).  
 No pitot.

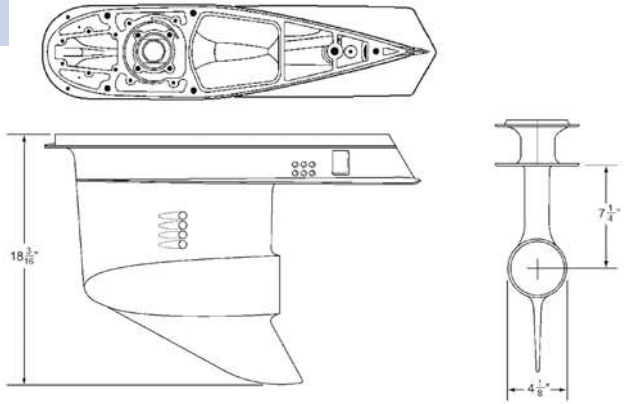

**V4 60°**

**Cola pequeña (1995-06)**

Altura: 19-1/16"  
 Final de la aleta de cavitación plano  
 Dos ranuras sobre la aleta de cavitación  
 Tomas externas de agua.

**Small Gearcase (1995-06)**

19-1/16" tall.  
 Flat at the trailing end of the cavitation plate.  
 Two slots above the cavitation plate.  
 External water intake screens.

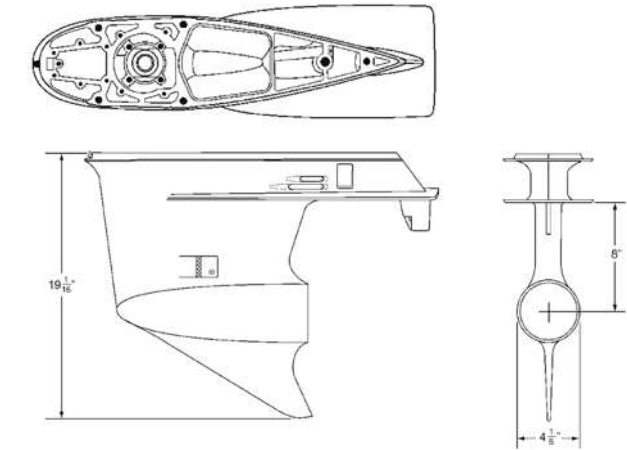

**V4 / V6**

**Cola larga "O" (1979-06)**

Altura: 19-3/16"  
 Final de la aleta de cavitación afilado  
 Dos ranuras sobre la aleta de cavitación  
 Tomas externas de agua

**Large Gearcase "O" type (1979-06)**

19-3/16" tall.  
 Pointed at the trailing end of the cavitation plate.  
 Two slots above the cavitation plate.  
 External water intake screens.

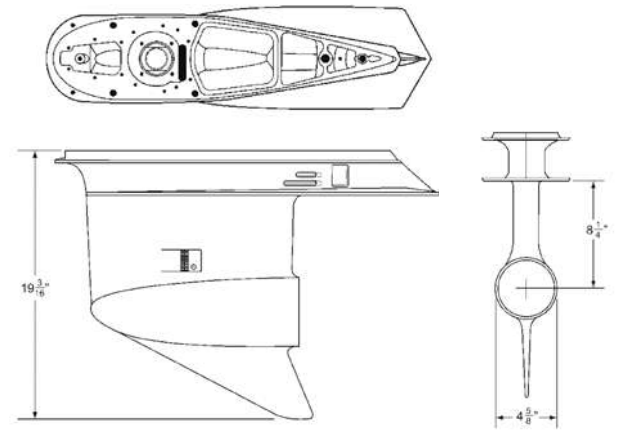

**Cola larga "M" (2002-06)**

Altura: 19-3/16"  
 Final de la aleta de cavitación plano  
 Tres ranuras sobre la aleta de cavitación  
 Tomas externas de agua  
 Con tubo corredera

**Large Gearcase "M" type (2002-06)**

19-3/16" tall.  
 Flat at the trailing end of the cavitation plate.  
 Three slots above the cavitation plate.  
 External water intake screens.  
 Includes speedo pitot.

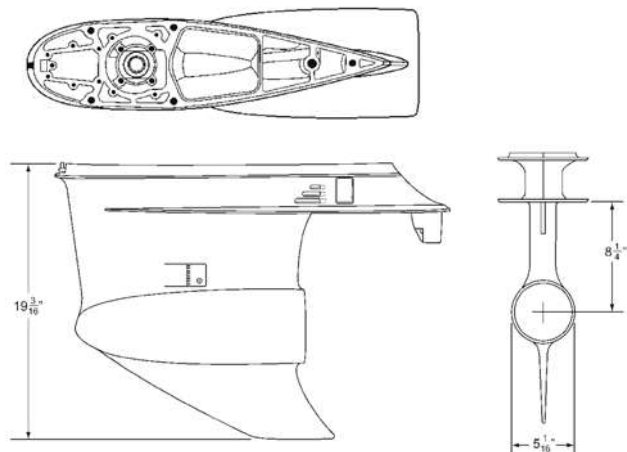

# DESPIECE COLAS 4 TIEMPOS

# GEAR CASE PARTS 4 STROKES

**4T** J4, J5, J6 HP  
STROKES

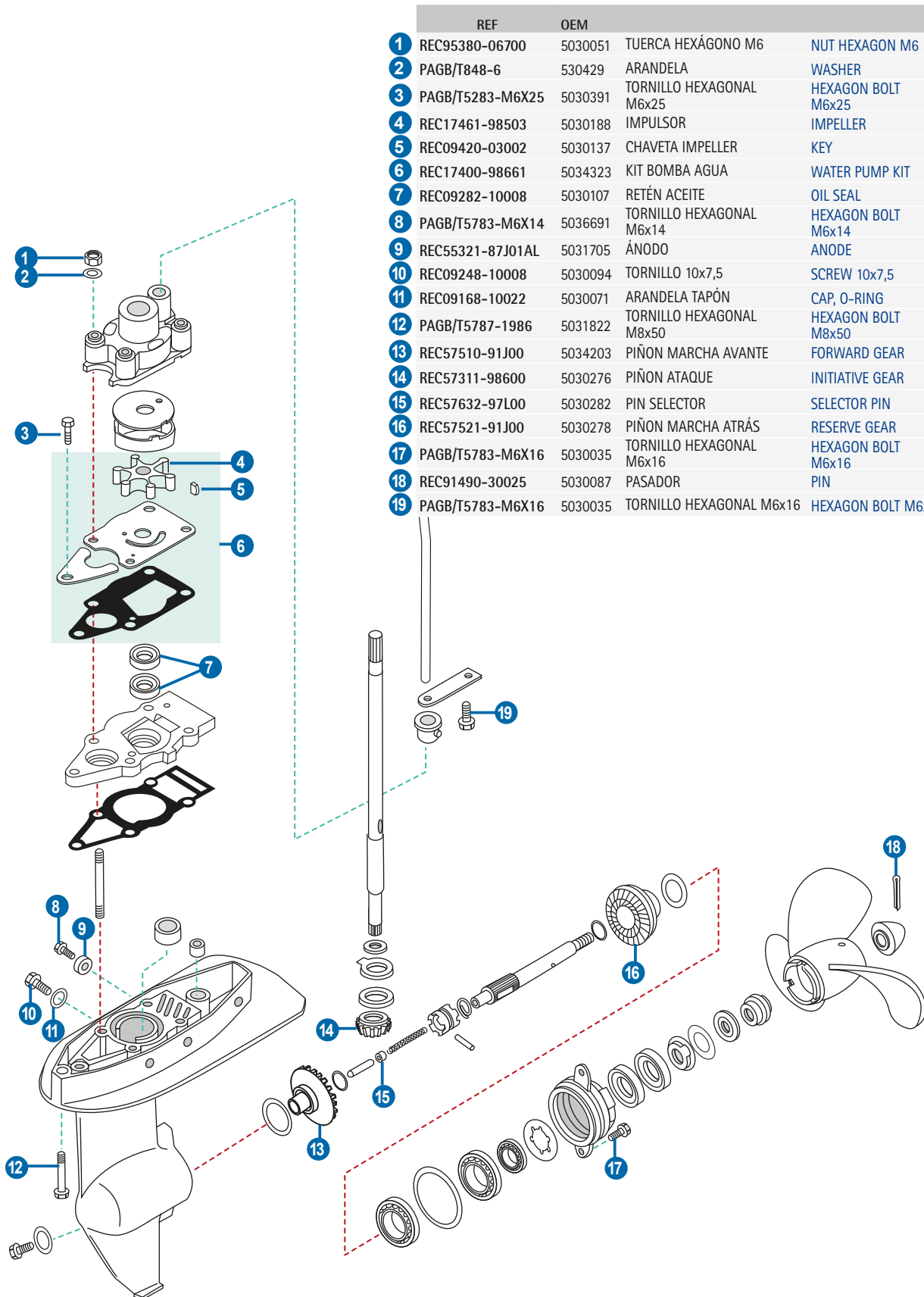

	REF	OEM		
1	REC95380-06700	5030051	TUERCA HEXÁGONO M6	NUT HEXAGON M6
2	PAGB/T848-6	530429	ARANDELA	WASHER
3	PAGB/T5283-M6X25	5030391	TORNILLO HEXAGONAL M6x25	HEXAGON BOLT M6x25
4	REC17461-98503	5030188	IMPULSOR	IMPELLER
5	REC09420-03002	5030137	CHAVETA IMPELLER	KEY
6	REC17400-98661	5034323	KIT BOMBA AGUA	WATER PUMP KIT
7	REC09282-10008	5030107	RETÉN ACEITE	OIL SEAL
8	PAGB/T5783-M6X14	5036691	TORNILLO HEXAGONAL M6x14	HEXAGON BOLT M6x14
9	REC55321-87J01AL	5031705	ÁNODO	ANODE
10	REC09248-10008	5030094	TORNILLO 10x7,5	SCREW 10x7,5
11	REC09168-10022	5030071	ARANDELA TAPÓN	CAP, O-RING
12	PAGB/T5787-1986	5031822	TORNILLO HEXAGONAL M8x50	HEXAGON BOLT M8x50
13	REC57510-91J00	5034203	PIÑÓN MARCHA AVANTE	FORWARD GEAR
14	REC57311-98600	5030276	PIÑÓN ATAQUE	INITIATIVE GEAR
15	REC57632-97L00	5030282	PIN SELECTOR	SELECTOR PIN
16	REC57521-91J00	5030278	PIÑÓN MARCHA ATRÁS	RESERVE GEAR
17	PAGB/T5783-M6X16	5030035	TORNILLO HEXAGONAL M6x16	HEXAGON BOLT M6x16
18	REC91490-30025	5030087	PASADOR	PIN
19	PAGB/T5783-M6X16	5030035	TORNILLO HEXAGONAL M6x16	HEXAGON BOLT M6x16

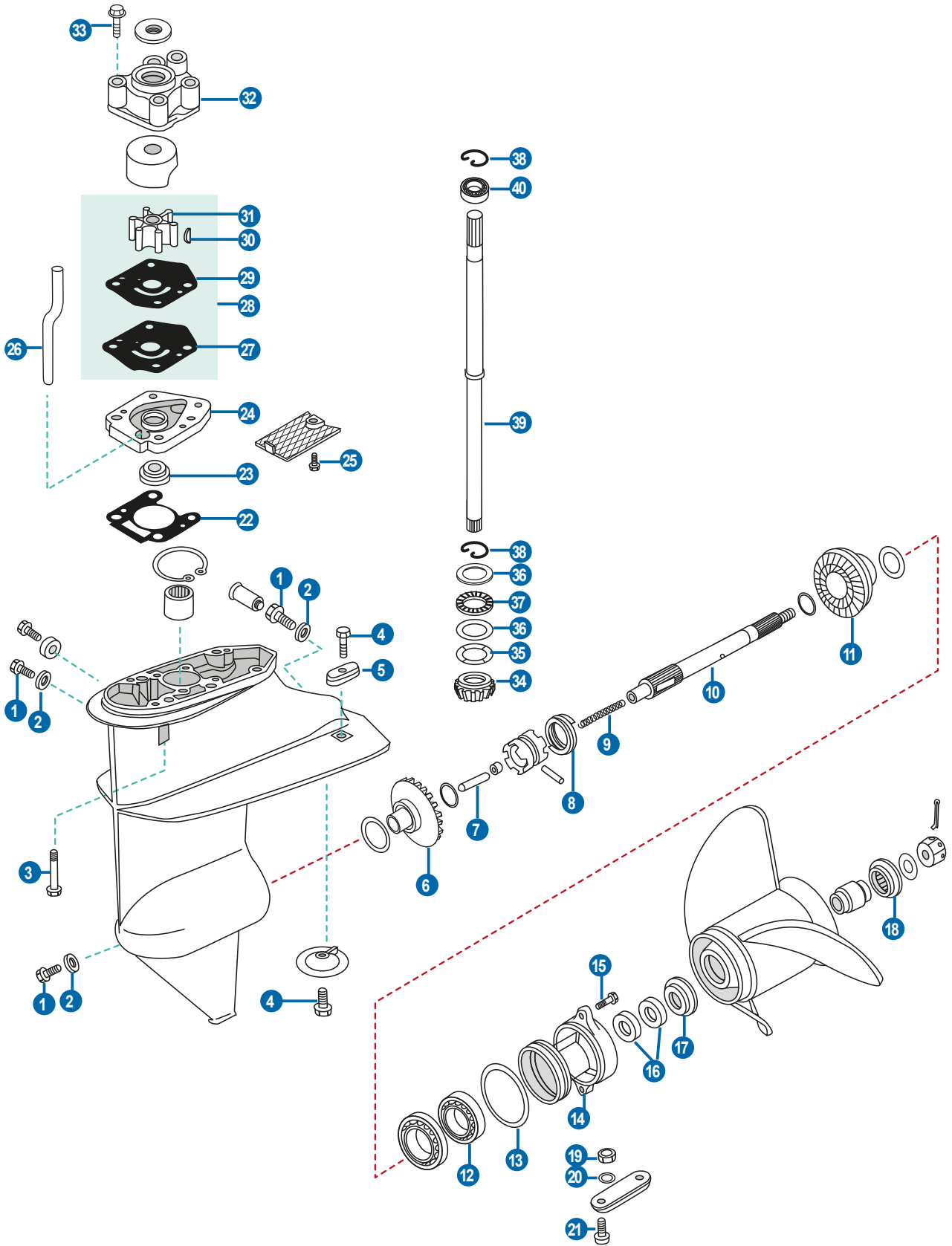

	REF	OEM		
1	REC09248-10008	5030094	TORNILLO 10x7,5	SCREW 10x7,5
2	REC09168-10022	5030071	ARANDELA TAPÓN	CAP, O-RING
3	PAGB/T5783-M8X30	5031216	TORNILLO M8X30	BOLT M8X30
4	REC09116-06094	5030034	TORNILLO 6x15	SCREW 6x15
5	REC55320-98400AL	5033167	ÁNODO	ANODE
6	REC57510-93910	5033191	PIÑÓN MARCHA AVANTE	FORWARD GEAR
7	REC57631-93901	5033196	VARILLA SELECTOR	ROD PUSH
8	REC09440-32008	5033037	MUELLE	CLUTCH
9	REC09440-05027	5033034	MUELLE SELECTOR	SELECTOR SPRING
10	REC57610-93901	5033193	EJE HELICE	PROPELLER SHAFT
11	REC57521-93910	5033192	PIÑÓN MARCHA ATRÁS	REVERSER GEAR
12	REC08110-60050	5033303	RODAMIENTO	BEARING
13	REC09280-57002	5033010	ARO TORICO	O-RING
14	REC56120-93900	5032743	DIÁBOLO	CARRIER
15	PAGB/T5787-M6X20	50030396	TORNILLO	BOLT, FLANGE
16	REC09289-17006	5033015	RETÉN ACEITE	OIL SEAL
17	REC57632-94J00	5033197	SEPARADOR HÉLICE	PROPELLER WASHER
18	REC57633-93901	5033198	SEPARADOR	SPACER
19	REC95380-06700	5030051	TUERCA HEXÁGONAL M6	HEXAGON NUT M6
20	PAGB/T93-6	5030068	ARANDELA MUELLE 6	SPRING WASHER 6
21	PAGB/T820-M6X20	5032945	TORNILLO M6x20	SCREW M6x20
22	REC17452-93910	5033110	JUNTA COLA	DRIVE GASKET
23	REC09289-12003	5033014	RETÉN	OIL SEAL
24	REC17450-93921	5033109	CARCASA BOMBA AGUA	PUMP BASE
25	PAGB/T818-M6X10	5030409	TORNILLO M6x10	BOLT M6x10
26	REC17453-93901	5033111	TUBO VACIADO DE AGUA	WATER TUBE
27	REC17472-93911	5035603	JUNTA BOMBA AGUA	WATER PUMP GASKET
28	REC17400-93951	5033106	KIT BOMBA AGUA	WATER PUMP SERVICE KIT
29	REC17471-93902	5033114	BASE BOMBA AGUA	WATER PUMP PLATE
30	REC17462-93990	5033113	CHAVETA	KEY
31	REC17461-93903	5033112	IMPULSOR	IMPELLER
32	REC17411-93901	5033107	CUERPO BOMBA AGUA	HOUSING WATER PUMP
33	PAGB/T5783-M8X55	5032766	TORNILLO HEXAGONAL M8x55	BOLT HEXAGON M8x55
34	REC57311-93910	5033190	PIÑÓN ATAQUE	INITIATIVE GEAR
35	REC09160-20041	5032985	GRUESO 1.00	SHIM 1.00
	REC09160-20042	5032967	GRUESO 1.10	SHIM 1.10
	REC09160-20043	5032968	GRUESO 1.20	SHIM 1.20
	REC09160-20044	5032969	GRUESO 1.30	SHIM 1.30
36	REC09160-21009	5032970	ARANDELA PIÑÓN	WASHER GEAR
37	REC09263-20L04	5033003	RODAMIENTO	BEARING
38	REC09380-15001	5033027	CIRCLIP	CLIP
39	REC57100-93902	5033188	EJE VERTICAL	DRIVE SHAFT
40	REC08110-60020	5033299	RODAMIENTO	BEARING



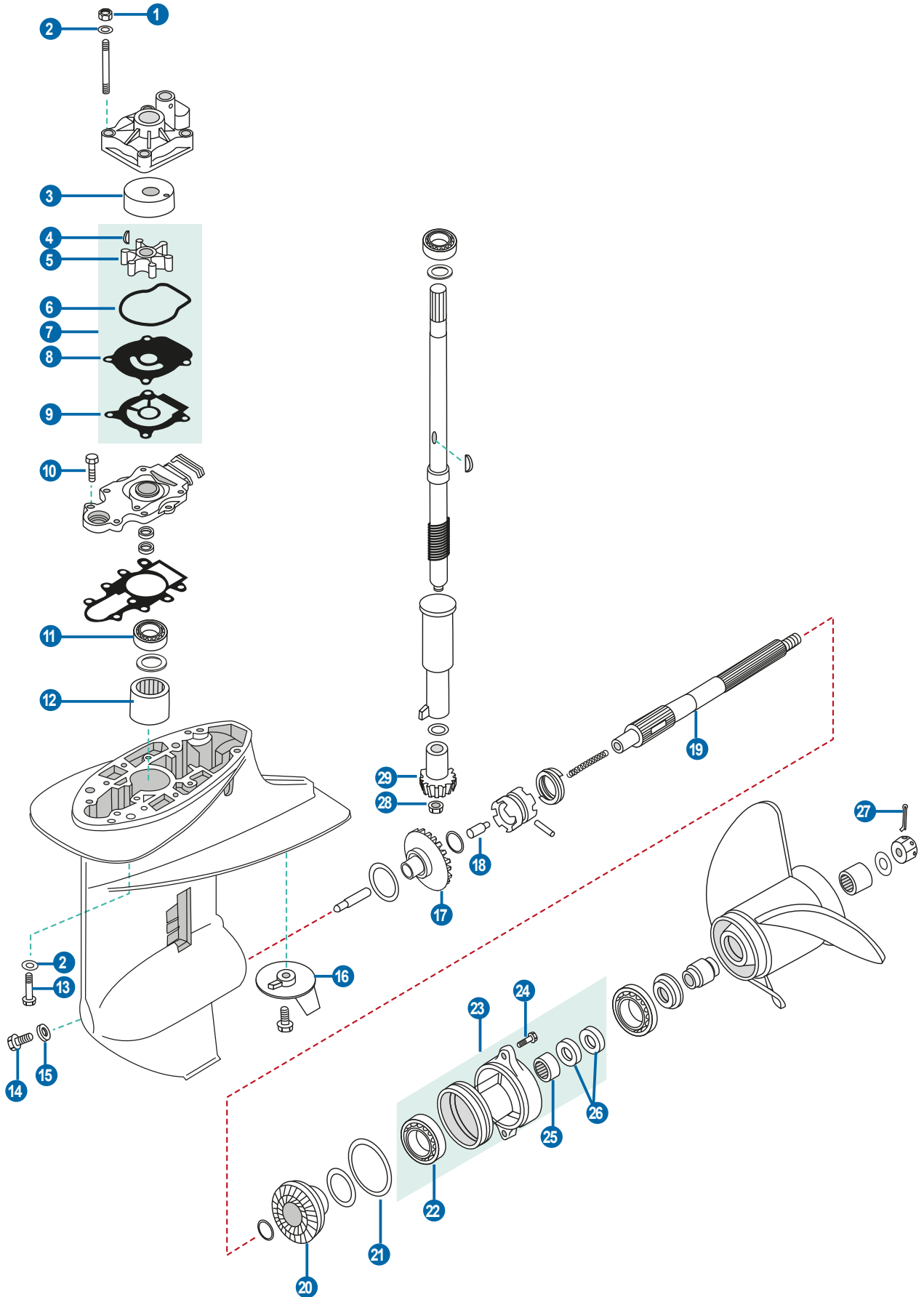

	REF	OEM		
1	REC95380-06700	5030051	TUERCA HEXÁGONO M6	NUT HEXAGON M6
2	PAGB/T848-6	5030429	ARANDELA	WASHER
3	REC17413-95J00	5036900	CASQUILLO INOX	SLEEVE WATER PUMP
4	REC09420-04006	5031281	CHAVETA	KEY
5	REC17461-96312	5031417	IMPULSOR	IMPELLER
6	REC17416-95J00	5036901	ARO TÓRICO	O-RING
7	REC17400-95J02	5036908	KIT BOMBA DE AGUA	WATER PUMP KIT
8	REC17471-95J01	5036902	TAPA DEL IMPULSOR	OUTER PLATE CARTRIDGE
9	REC17472-96303	5036681	JUNTA DE LA BOMBA DE AGUA	WATER PUMP, GASKET
10	REC09116-06094	5030034	TORNILLO 6x15	SCREW 6x15
11	REC09265-17002	5031885	RODAMIENTO	BEARING
12	REC09263-20046	5031883	RODAMIENTO	BEARING
13	PAGB/T5787-M6X30	5030394	TORNILLO M6x30	BOLT M6x30
14	REC09248-10008	5030094	TORNILLO 10x7,5	SCREW 10x7,5
15	REC09168-10022	5030071	ARANDELA TAPÓN	CAP, O-RING
16	REC55125-91L01AL	5032091	ÁNODO	ANODE
17	REC57510-89J00	5032689	PIÑÓN MARCHA AVANTE	POSITIVE GEAR
18	REC09209-08016	5031880	VARILLA PRESION ACEITE	ROD PUSH
19	REC57610-96311	5032101	EJE HELICE	PROPELLER SHAFT
20	REC57521-89J00	5032100	PIÑÓN MARCHA ATRÁS	REVERSER GEAR
21	REC09280-75001	5031263	ARO TÓRICO	O-RING
22	REC08113-60060	5032295	RODAMIENTO	BEARING
23	REC56120-96332-0EP	5034711	DIÁBOLO	CARRIER
24	REC09116-06121	5030391	TORNILLO	BOLT
25	REC09263-20047	5031884	RODAMIENTO	BEARING
26	REC09289-20009	5031893	RETÉN ACEITE	OIL SEAL
27	REC91490-30025	5030087	PIN BLOQUEADOR	COTTER PIN
28	REC90179-08M06	5031827	TUERCA DE PIÑÓN M8X1	NUT, PINION M8X1
29	REC57311-96320	5032098	PIÑÓN ATAQUE	INITIATIVE GEAR

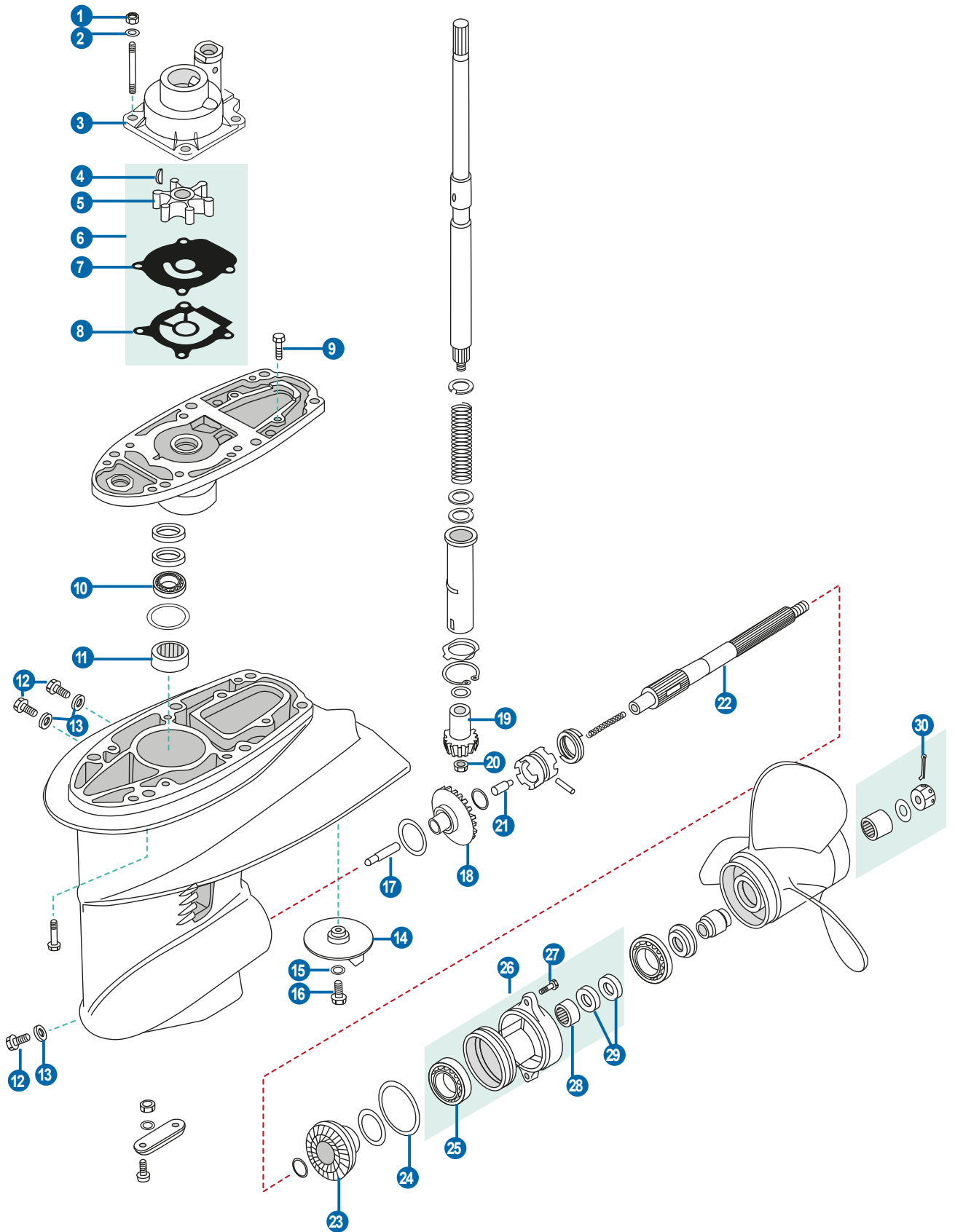

	REF	OEM		
1	PAGB/T6184-2000	5030051	TUERCA M6	NUT M6
2	PAGB/T848-6	5030068	ARANDELA	WASHER
3	REC17411-94421	5031990	CUERPO BOMBA AGUA	HOUSING WATER PUMP
4	REC09420-04006	5031281	CHAVETA	KEY
5	REC17461-96312	5031417	IMPULSOR	IMPELLER
6	REC17400-96403	5031744	KIT BOMBA DE AGUA	WATER PUMP KIT
7	REC17471-94401	5031418	BASE BOMBA AGUA	PLATE, WATER PUMP
8	REC17472-96303	5036681	JUNTA DE LA BOMBA DE AGUA	WATER PUMP, GASKET
9	PAGB/T5787-M6X20	5030037	TORNILLO	BOLT, FLANGE
10	REC09265-17002	5031885	RODAMIENTO	BEARING
11	REC09263-20046	5031883	RODAMIENTO	BEARING
12	REC09248-10008	5030094	TORNILLO 10x7,5	SCREW 10x7,5
13	REC09168-10022	5030071	ARANDELA TAPÓN	CAP, O-RING
14	REC55125-91L01AL	5032191	ÁNODO	ANODE
15	PAGB/T97.1-8		ARANDELA 8	WASHER 8
16	PAGB/T5783-M8X16	5031215	TORNILLO M8x16	BOLT M8x16
17	REC57631-96301	5032103	VARILLA PRESION ACEITE	ROD PUSH
18	REC57510-89J00	5032698	PIÑÓN MARCHA AVANTE	POSITIVE GEAR
19	REC57311-96320	5032098	PIÑÓN ATAQUE	INITIATIVE GEAR
20	REC90179-08M06	5031827	TUERCA DE PIÑÓN M8X1	NUT, PINION M8X1
21	REC09209-08016	5031880	VARILLA PRESION ACEITE	ROD PUSH
22	REC57610-96311	5032101	EJE HELICE	PROPELLER SHAFT
23	REC57521-89J00	5032100	PIÑÓN MARCHA ATRÁS	REVERSER GEAR
24	REC925093	5031890	ARO TORICO SUPERIOR	O-RING UPPER
25	REC08113-60060	5032295	RODAMIENTO	BEARING
26	REC56120-96332-0EP	5034711	DIÁBOLO	CARRIER
27	REC09116-06121	5030391	TORNILLO	BOLT
28	REC09263-20047	5031884	RODAMIENTO	BEARING
29	REC09289-20009	5031893	RETÉN ACEITE	OIL SEAL
30	REC91490-30025	5030087	PIN BLOQUEADOR	COTTER PIN

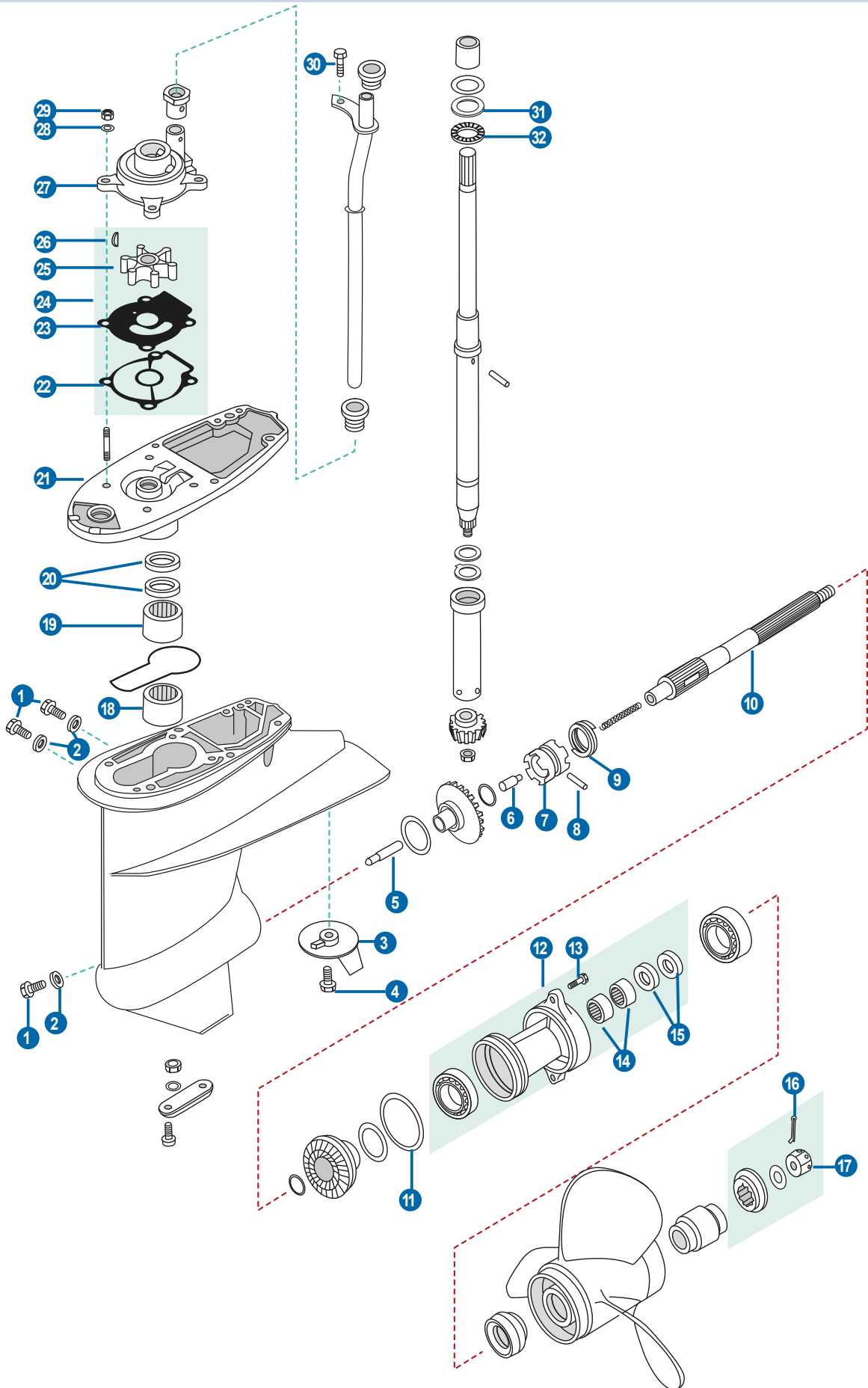

	REF	OEM		
1	REC09248-10008	5030094	TORNILLO 10x7,5	SCREW 10x7,5
2	REC09168-10022	5030071	ARANDELA TAPÓN	CAP, O-RING
3	REC55125-95500AL	5031536	ÁNODO	ANODE
4	PAGB/T5783-M8X16	5031215	TORNILLO M8x16	BOLT M8x16
5	REC57631-95303	5031549	VARILLA PRESION ACEITE	ROD PUSH
6	REC57634-88L00	5031251	PIN SELECTOR	CLUTCH PIN
7	REC57621-94403	5036059	SELECTOR	SELETORE
8	REC09202-04002	5030084	PIN HELICE	PROPELLER PIN
9	REC09440-40002	5031286	MUELLE SELECTOR	SPRING CLUTCH
10	REC57610-94402	5031546	EJE HELICE	PROPELLER SHAFT
11	REC09280-75001	5031263	ARO TÓRICO	O-RING
12	REC56120-94321-OEP	5032801	DIÁBOLO	CARRIER
13	PAGB/T5783-M8X30	5031216	TORNILLO M8x30	BOLT M8x30
14	REC09263-22020	5031255	RODAMIENTO	BEARING
15	REC09289-22007	5031270	RETÉN ACEITE	OIL SEAL
16	REC91490-30025	5030087	PIN BLOQUEADOR	COTTER PIN
17	REC90171-18M04	5030422	TUERCA	NUT
18	REC09263-22L03	5031256	RODAMIENTO	BEARING
19	REC09263-25025	5031257	RODAMIENTO	BEARING
20	REC09282-17005	5031264	RETÉN ACEITE	OIL SEAL
21	REC56130-94413-OEP	5032802	DIÁBOLO	CARRIER
22	REC17472-96303	5036681	JUNTA DE LA BOMBA DE AGUA	WATER PUMP, GASKET
23	REC17471-94401	5031418	BASE BOMBA AGUA	PLATE, WATER PUMP
24	REC17400-96403	5031744	KIT BOMBA DE AGUA	WATER PUMP KIT
25	REC17461-96312	5031417	IMPULSOR	IMPELLER
26	REC09420-04006	5031281	CHAVETA	KEY
27	REC17411-94421	5031990	CUERPO BOMBA AGUA	HOUSING WATER PUMP
28	PAGB/T93-6	5030068	ARANDELA 6	WASHER 6
29	REC95380-06700	5030051	TUERCA HEXÁGONO M6	NUT HEXAGON M6
30	REC09116-06094	5030034	TORNILLO 6x15	SCREW 6x15
31	REC09160-26015	5031232	ARANDELA PIÑÓN	WASHER GEAR
32	REC09263-25062	5031258	RODAMIENTO	BEARING



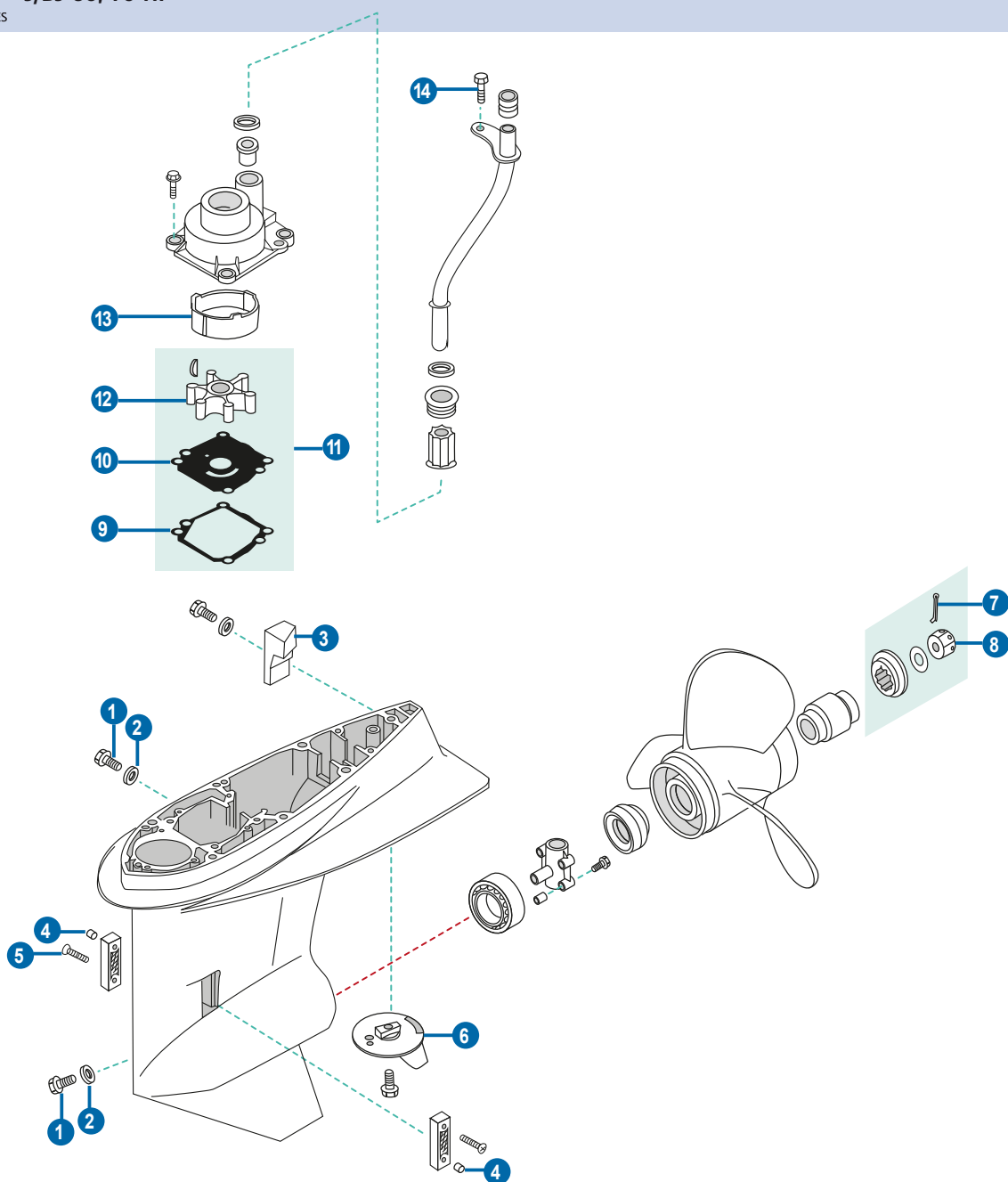

	REF	OEM		
1	REC09248-10008	5030094	TORNILLO 10x7,5	SCREW 10x7,5
2	REC09168-10022	5030071	ARANDELA TAPÓN	CAP, O-RING
3	REC55321-90J01AL	5032930	ÁNODO	ANODE
4	PAGB/T889.1-M4	5030415	TUERCA HEXAGONAL M4	NUT HEXAGON M4
5	PAGB/T818-M4X30	5030405	TORNILLO M4x30	SCREW PAN HEAD M4x30
6	REC55125-90J01AL	5032929	ÁNODO	ANODE
7	REC91490-30025	5030087	PIN BLOQUEADOR	COTTER PIN
8	REC90171-18M04	5030422	TUERCA	NUT
9	REC17472-87E10	5030725	JUNTA BOMBA AGUA	WATER PUMP GASKET
10	REC17471-92J00	5034651	PLACA BOMBA DE AGUA	PATE, WATER PUMP
11	REC17400-87E04	5031731	KIT REPARACION BOMBA AGUA	WATER PUMP KIT
12	REC17461-87E12	5030723	IMPULSOR	IMPELLER
13	REC17413-99E11		CASQUILLO INOX	INSERT CUP
14	PAGB/T5783-M6X16	5030038	TORNILLO HEXAGONAL M6x16	BOLT HEXAGON M6x16

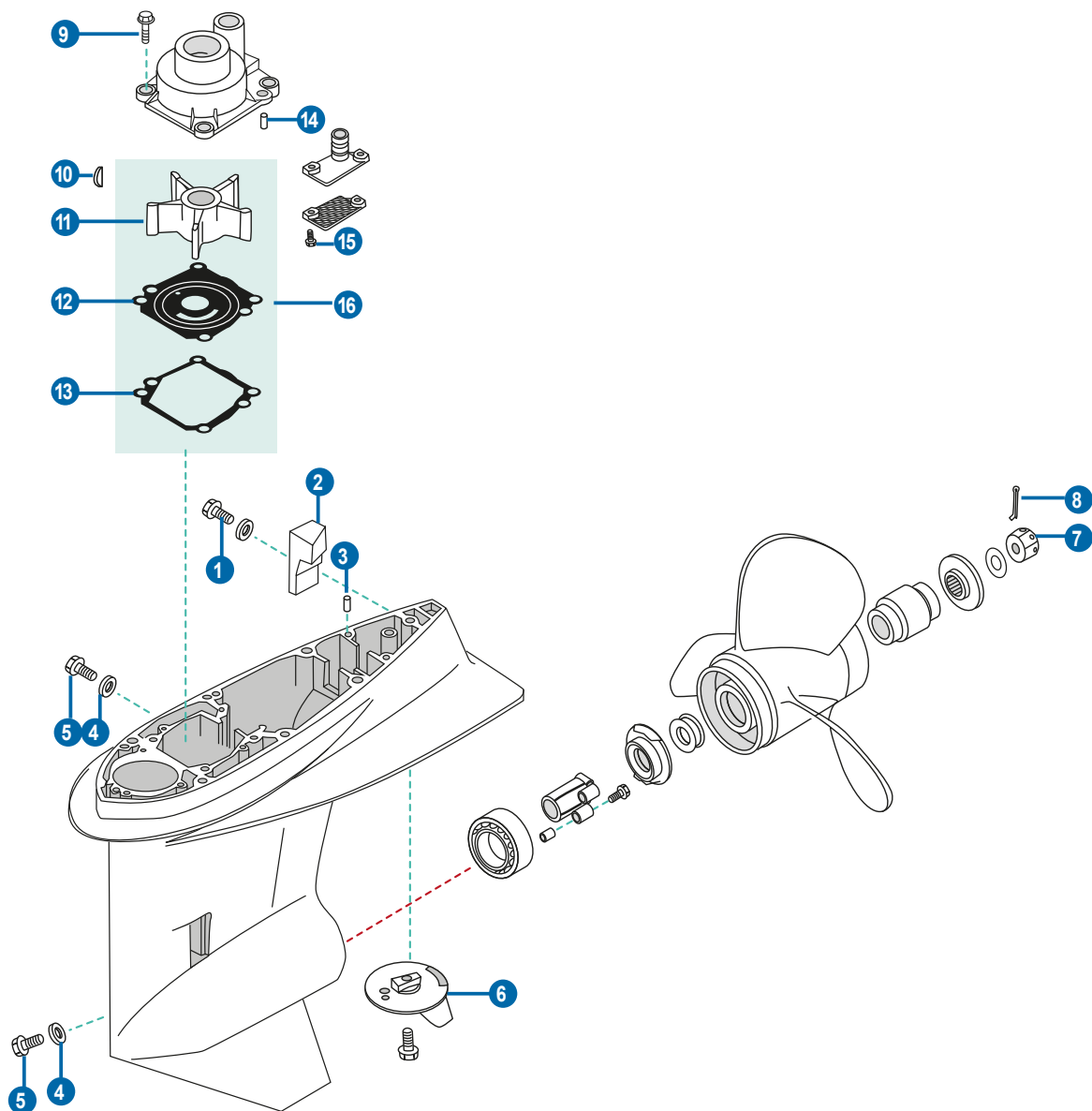

	REF	OEM		
1	PAGB/T5783-M6X12	5030338	TORNILLO M6x12	BOLT M6x12
2	REC55321-90J01AL	5032930	ÁNODO	ANODE
3	PAF25-00000014	5030511	PIN CENTRADOR F8x12	PIN, DOWEL F8x12
4	REC09168-10022	5030071	TORNILLO 10x7,5	SCREW 10x7,5
5	REC09248-10008	5030094	ARANDELA TAPÓN	CAP, O-RING
6	REC55125-90J01AL	5032929	ÁNODO	ANODE
7	REC90171-18M04	5030422	TUERCA	NUT
8	REC91490-30025	5030087	PIN BLOQUEADOR	COTTER PIN
9	PAGB/T5783-M8X25	5030398	PERNO M8X25	BOLT M8X25
10	REC09420-05009	5034842	CHAVETA	KEY
11	REC17461-90J01	5033542	IMPULSOR	IMPELLER
12	REC17471-92J00	5037170	TAPA DEL IMPULSOR	OUTER PLATE CARTRIDGE
13	REC17472-87E10	5030725	JUNTA BOMBA AGUA	WATER PUMP GASKET
14	REC93606-12019	5030508	PIN F6X12	PIN F6X12
15	PAGB/T8.8-2000	5030406	TORNILLO M5X12	SCREW, PAN HEAD M5X12
16	REC17400-90J20	5033541	KIT BOMBA DE AGUA	WATER PUMP KIT

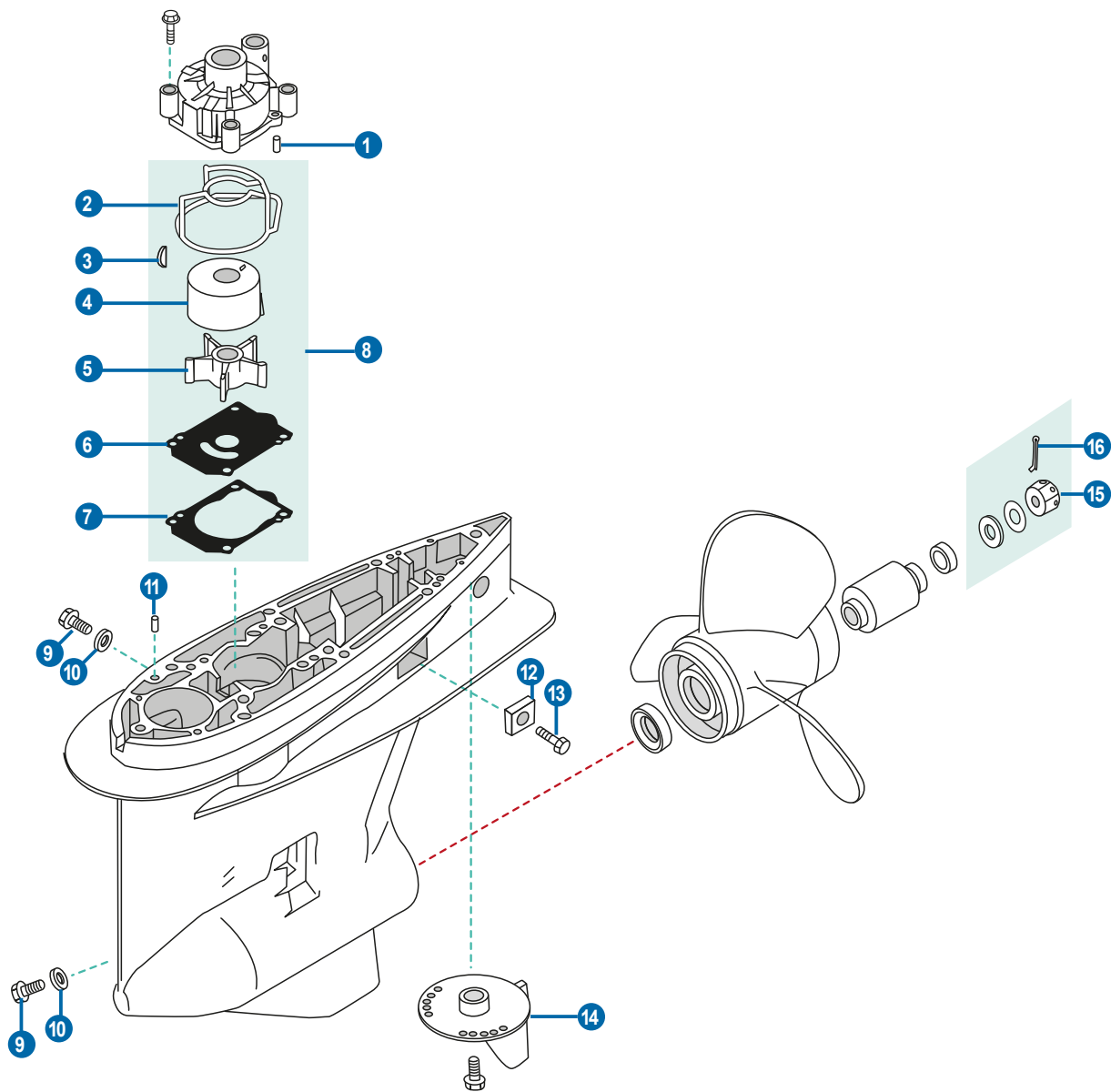

	REF	OEM		
1	REC93606-12019	5030508	PIN F6X12	PIN F6X12
2	REC17416-96J00	5035039	JUNTA TORICA	O-RING
3	REC09420-05009	5034842	CHAVETA	KEY
4	REC17413-96J01	5035038	CASQUILLO INOX	SLEEVE WATER PUMP
5	REC17461-90J01	5033542	IMPULSOR	IMPELLER
6	REC17471-92J02	5035041	TAPA DEL IMPULSOR	IMPELLER PLATE
7	REC17472-93J00	5035042	JUNTA	GASKET
8	REC17400-96J03	5035036	KIT BOMBA DE AGUA	WATER PUMP KIT
9	REC55128-93J10	5035151	TAPON DRENAJE COLA	WATER PLUG DRAIN
10	REC09168-10034	5034799	JUNTA	GASKET
11	PAF25-00000014	5030511	PIN CENTRADOR F8x12	PIN, DOWEL F8x12
12	REC55320-95311AL	5035786	ÁNODO	ANODE
13	REC09116-06094	5030034	TORNILLO 6x15	SCREW 6x15
14	REC55125-90J01AL	5035150	ÁNODO	ANODE
15	REC90171-18M04	5030422	TUERCA	NUT
16	REC91490-30025	5030087	PIN BLOQUEADOR	COTTER PIN

DESPIECE COLAS  
2 TIEMPOS

GEAR CASE PARTS  
2 STROKES

2T 4, 4.5, 5, 6, 7.5, 8 HP (1980+)  
STROKES

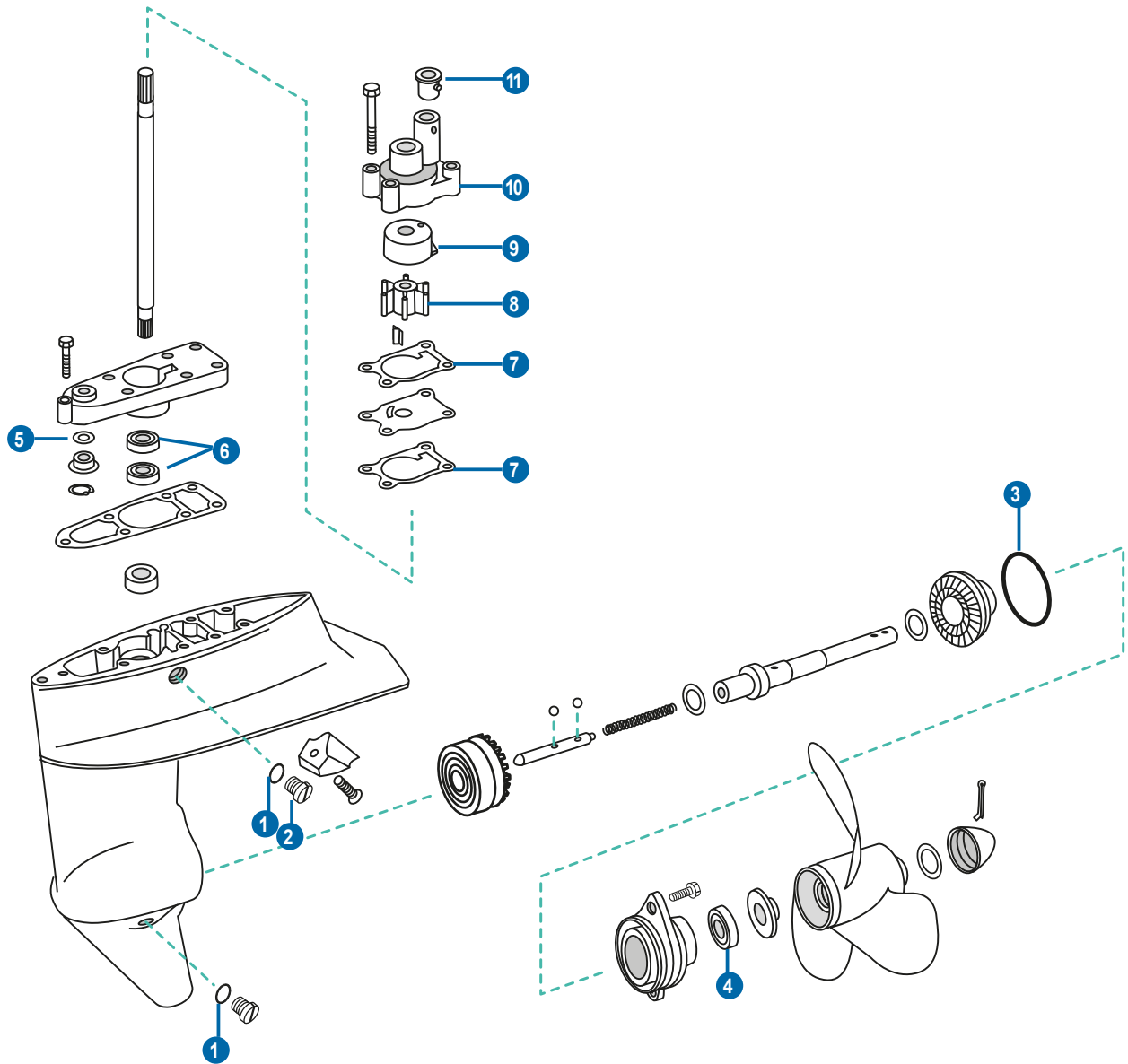

	REF	OEM		
1	REC12-191833	307552	JUNTA	GASKET
2	REC10-79953Q04	307551	JUEGO TORNILLOS	SCREW SET
3	REC322494	322494	JUNTA TORICA	O-RING
4	REC336493	336493	RETÉN ACEITE	OIL SEAL
5	REC305242	305242	JUNTA TORICA	O-RING
6	REC324639	324639	RETÉN ACEITE	OIL SEAL
7	REC325040	325040	JUNTA	GASKET
8	REC389576	436137	IMPULSOR	IMPELLER
9	REC324641	324641	TAPA BOMBA	PUMP CUP
10	REC389577	389577	CUERPO BOMBA	PUMP HOUSING
11	REC302497	302497	GRUESO 20"	GROMMET 20"

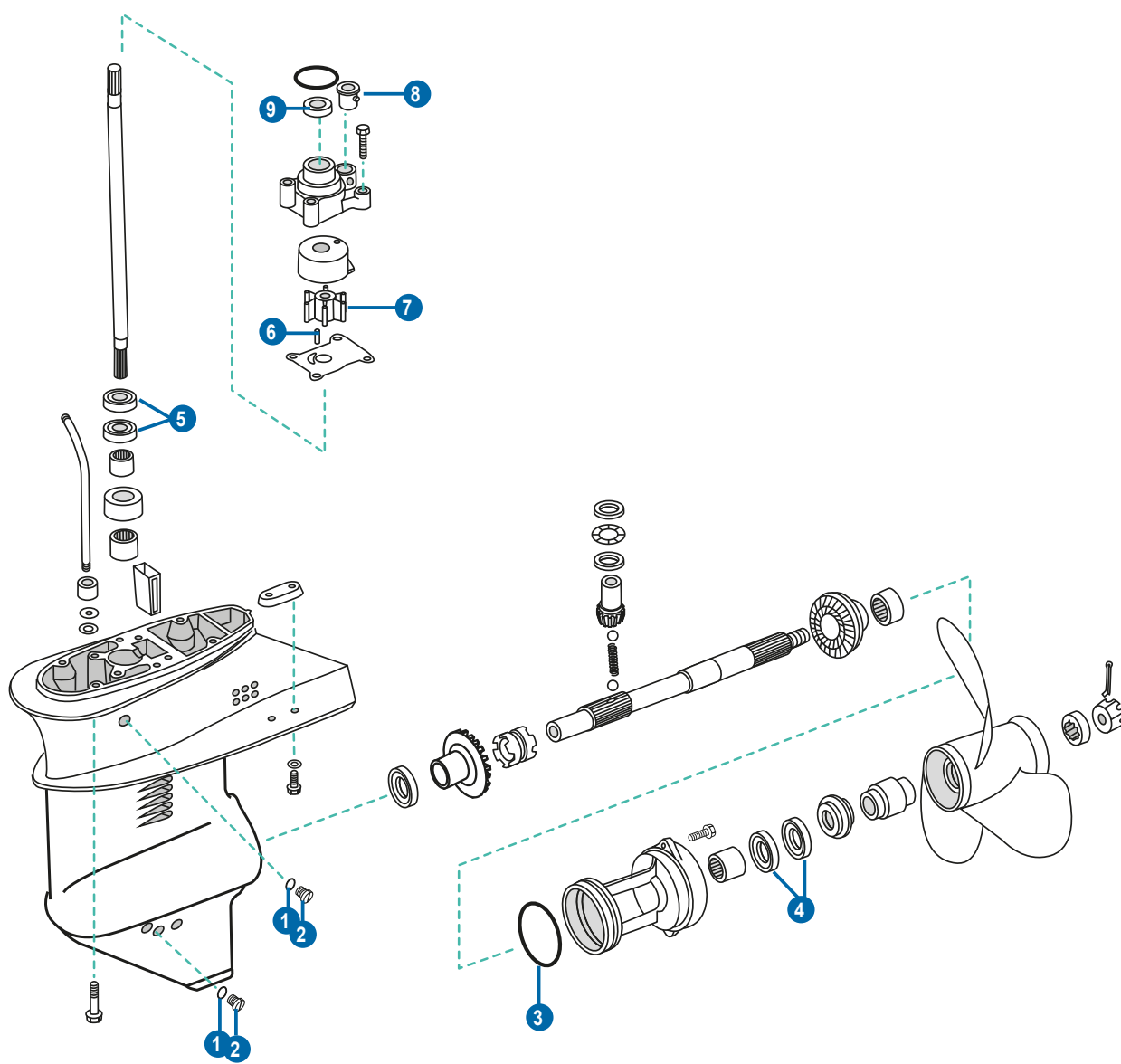

	REF	OEM		
1	REC12-191833	307552	JUNTA	GASKET
2	REC10-79953Q04	307551	JUEGO TORNILLO	SCREW SET
3	REC308627	308627	TÓRICA	O-RING
4	REC321481	321481	RETÉN ACEITE	OIL SEAL
5	REC321480	321480	RETÉN ACEITE	OIL SEAL
6	REC300611	300611	CHAVETA	KEY
7	REC386084	386084	IMPULSOR	IMPELLER
8	REC302497	302497	GRUESO	GROMMET
9	REC318972	318972	RETÉN ACEITE	OIL SEAL

**2T 25 - 28 HP 2 CYL CROSSFLOW (1978-97)**  
 STROKES ESCAPE POR ALETA DE CAVITACIÓN | THRU-CAVITATION PLATE EXHAUST

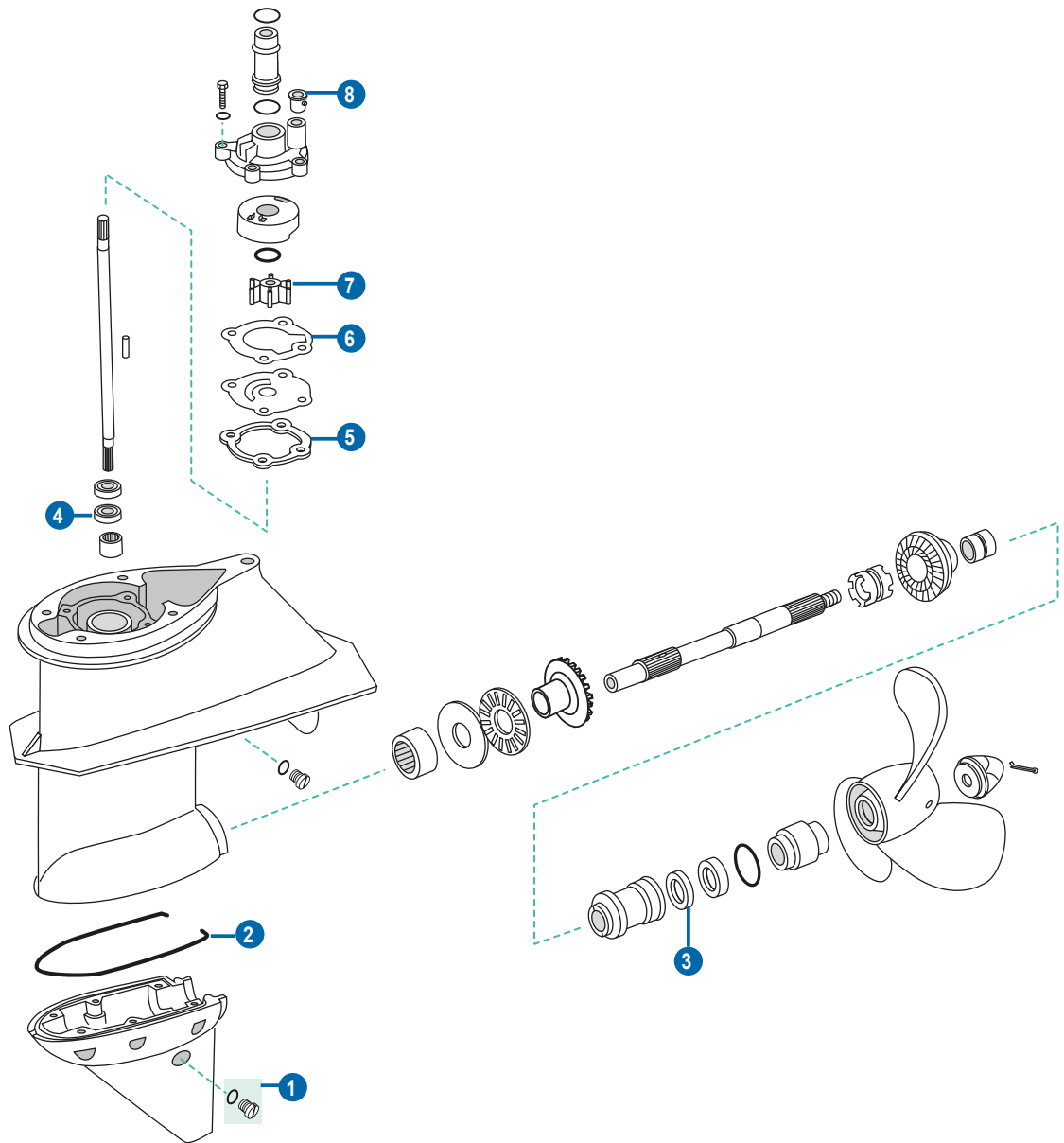

	REF	OEM		
1	REC10-79953Q04	307551	TORNILLO	SCREW
2	REC309004	309004	RETÉN	SEAL
3	REC321459	321459	RETÉN INTERIOR EJE HÉLICE	INNER PROP SHAFT SEAL
4	REC321459	321459	CIERRE INFERIOR EJE COLA	DRIVE SHAFT SEAL LOWER
5	REC324449	324449	JUNTA	GASKET
6	REC329390	329390	JUNTA	GASKET
7	REC395289	395289	IMPULSOR	IMPELLER
8	REC302497	302497	GRUESO	GROMMET

2T 20 - 35 HP 2 CYL CROSSFLOW (1980-05) • 25, 30, 35 HP 3 CYL LOOPCHARGED (1996-01)  
 STROKES ESCAPE POR HÉLICE | THRU-PROP EXHAUST

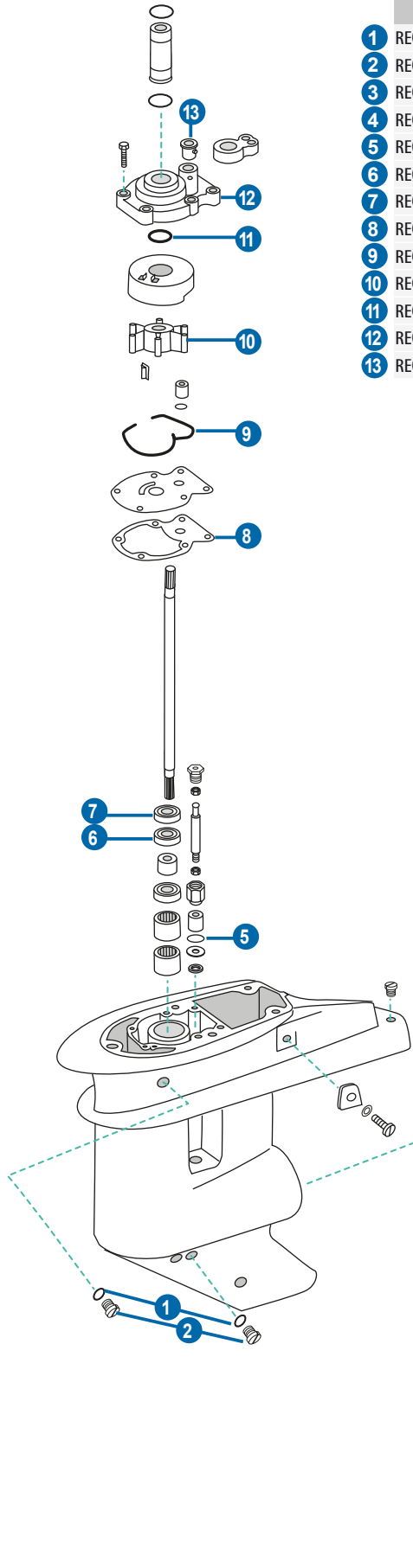

	REF	OEM		
1	REC3855081	311598	JUNTA	GASKET
2	REC10-79953Q04	307551	JUEGO TORNILLOS	SCREW SET
3	REC338518	338518	TÓRICA	O-RING
4	REC26-69188	321453	RETÉN ACEITE	OIL SEAL
5	REC303347	303347	TÓRICA	O-RING
6	REC321928	321928	RETÉN ACEITE	OIL SEAL
7	REC332261	332261	RETÉN ACEITE	OIL SEAL
8	REC325537	325537	JUNTA	GASKET
9	REC328753	328753	RETÉN	SEAL
10	REC395289	395289	IMPULSOR	IMPELLER
11	REC0554545	554545	TÓRICA	O-RING
12	REC393632	393632	CUERPO BOMBA 2 CIL.	PUMP HOUSING 2-CYL.
13	REC302497	302497	GRUESO PARA REC393632	GROMMET (FOR REC393632)

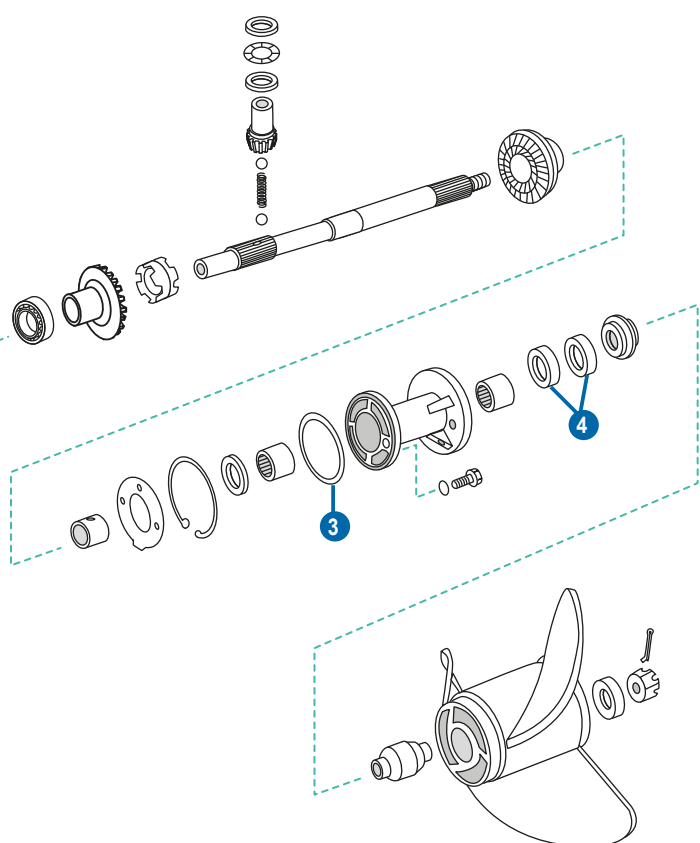
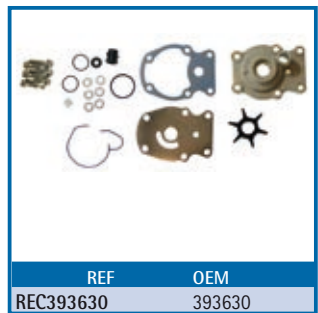
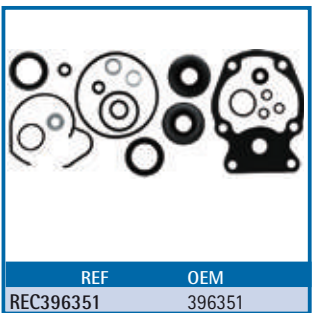

**2T 40 - 50 HP 2 CYL LOOPCHARGED (1989-05)**  
 STROKES COLA PEQUEÑA | SMALL GEARCASE

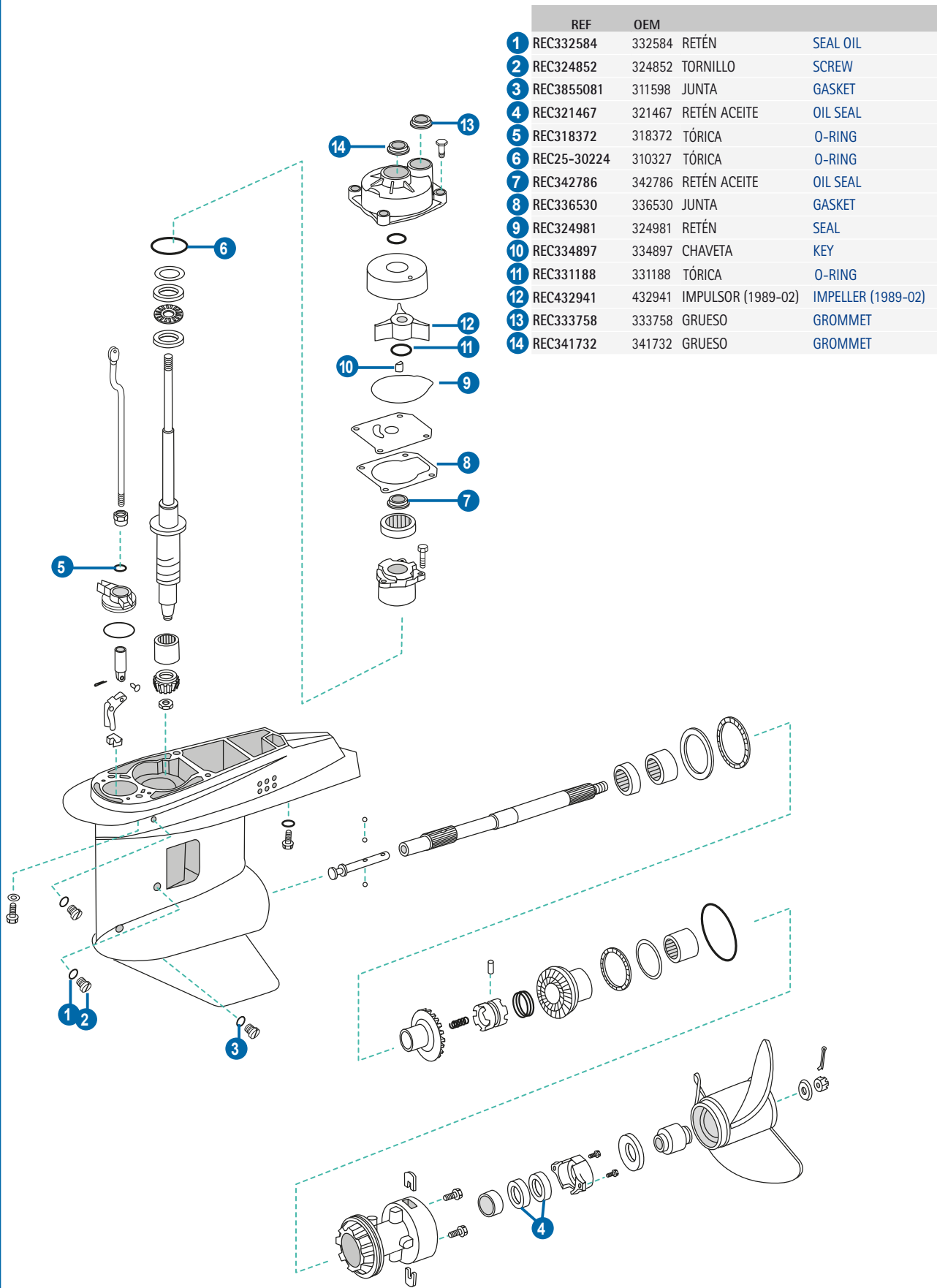

	REF	OEM		
1	REC332584	332584	RETÉN	SEAL OIL
2	REC324852	324852	TORNILLO	SCREW
3	REC3855081	311598	JUNTA	GASKET
4	REC321467	321467	RETÉN ACEITE	OIL SEAL
5	REC318372	318372	TÓRICA	O-RING
6	REC25-30224	310327	TÓRICA	O-RING
7	REC342786	342786	RETÉN ACEITE	OIL SEAL
8	REC336530	336530	JUNTA	GASKET
9	REC324981	324981	RETÉN	SEAL
10	REC334897	334897	CHAVETA	KEY
11	REC331188	331188	TÓRICA	O-RING
12	REC432941	432941	IMPULSOR (1989-02)	IMPELLER (1989-02)
13	REC333758	333758	GRUESO	GROMMET
14	REC341732	341732	GRUESO	GROMMET

2T 40 - 60 HP 2 CYL LOOPCHARGED (1975-88) • 60 - 75 HP 2 CYL LOOPCHARGED (1975-88)  
 STROKES COLA PEQUEÑA | SMALL GEARCASE

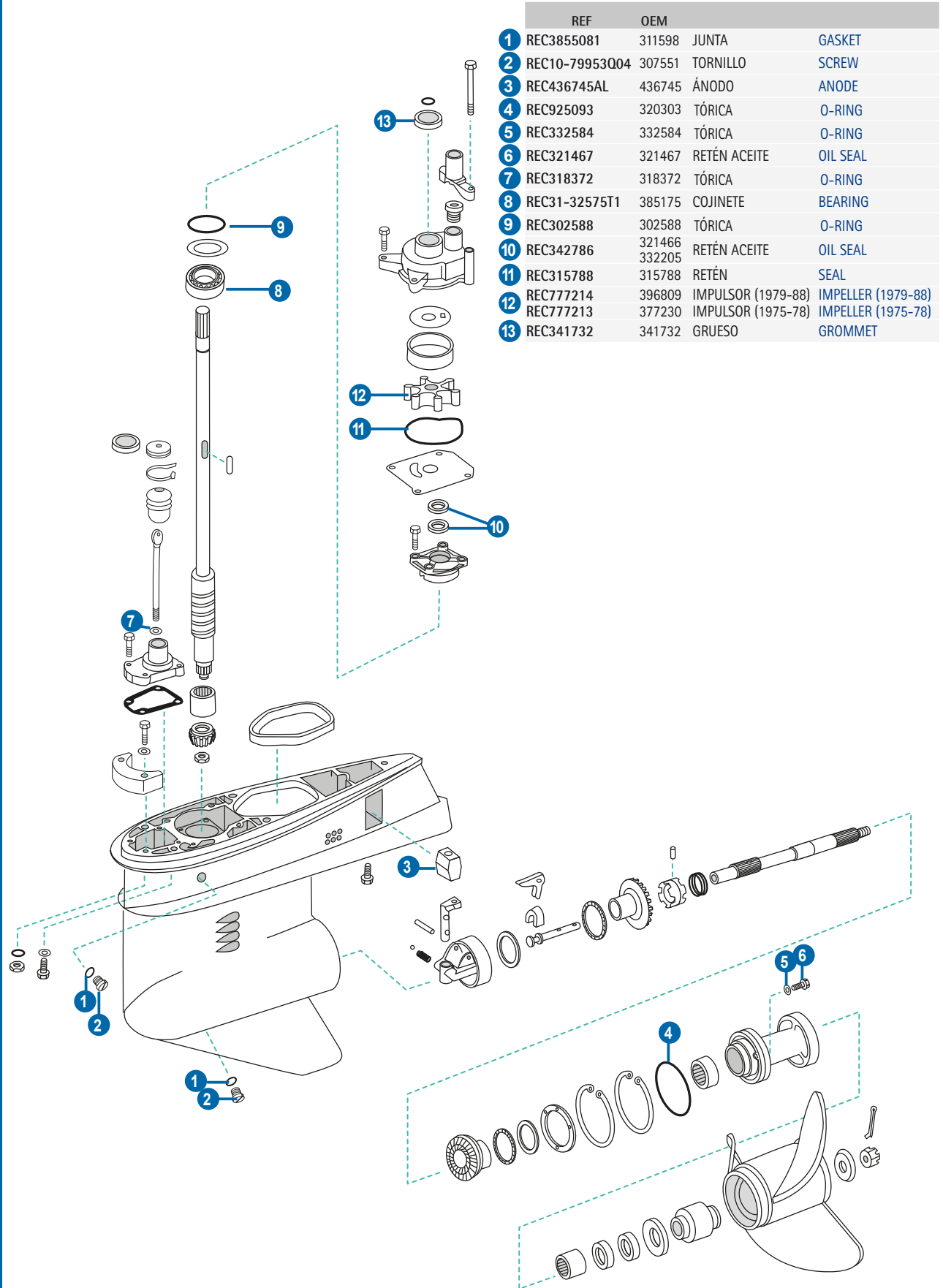

**2T 40 - 60 HP 2 CYL LOOPCHARGED (1975-06) • 60 - 75 HP 2 CYL LOOPCHARGED (1975-01)**  
 STROKES COLA LARGA | LARGE GEARCASE

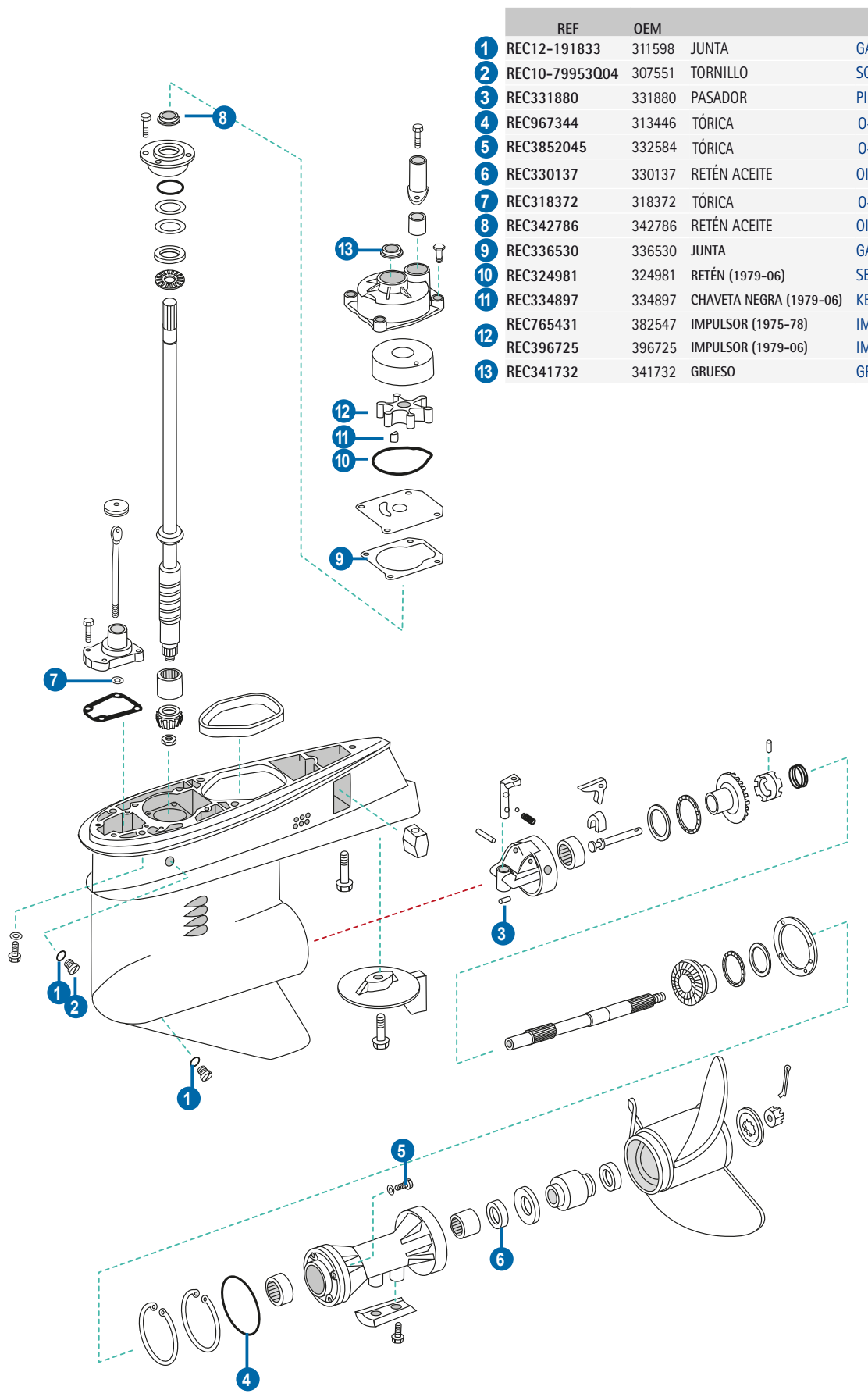

	REF	OEM		
1	REC12-191833	311598	JUNTA	GASKET
2	REC10-79953Q04	307551	TORNILLO	SCREW
3	REC331880	331880	PASADOR	PIN
4	REC967344	313446	TÓRICA	O-RING
5	REC3852045	332584	TÓRICA	O-RING
6	REC330137	330137	RETÉN ACEITE	OIL SEAL
7	REC318372	318372	TÓRICA	O-RING
8	REC342786	342786	RETÉN ACEITE	OIL SEAL
9	REC336530	336530	JUNTA	GASKET
10	REC324981	324981	RETÉN (1979-06)	SEAL (1979-06)
11	REC334897	334897	CHAVETA NEGRA (1979-06)	KEY, BLACK (1979-06)
12	REC765431	382547	IMPULSOR (1975-78)	IMPELLER (1975-78)
12	REC396725	396725	IMPULSOR (1979-06)	IMPELLER (1979-06)
13	REC341732	341732	GRUESO	GROMMET

JOHNSON EVINRUDE

2T V4 60° (1995-06) RATIO 2.00:1 (.50)  
STROKES

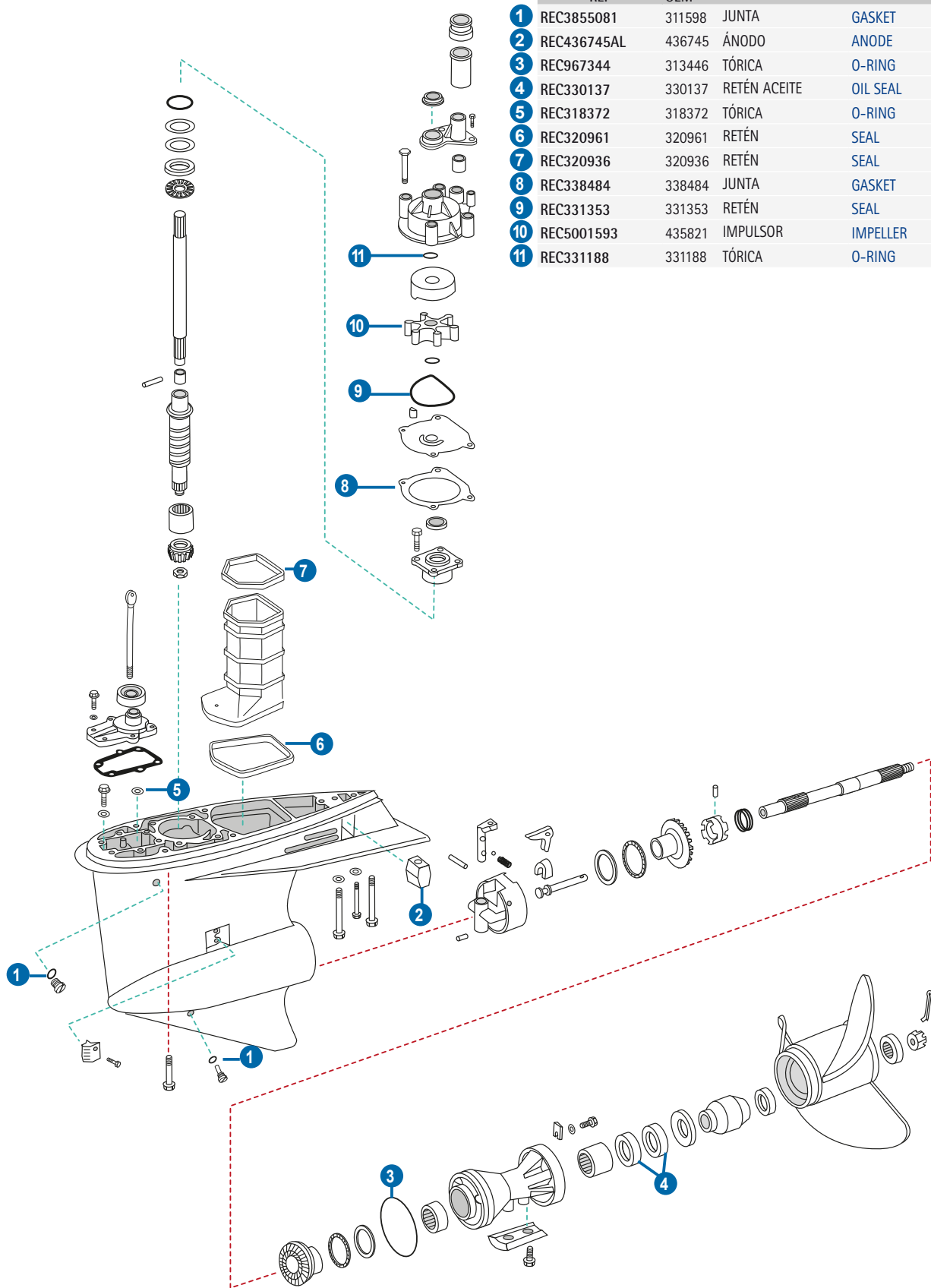

	REF	OEM	
1	REC3855081	311598	JUNTA GASKET
2	REC436745AL	436745	ÁNODO ANODE
3	REC967344	313446	TÓRICA O-RING
4	REC330137	330137	RETÉN ACEITE OIL SEAL
5	REC318372	318372	TÓRICA O-RING
6	REC320961	320961	RETÉN SEAL
7	REC320936	320936	RETÉN SEAL
8	REC338484	338484	JUNTA GASKET
9	REC331353	331353	RETÉN SEAL
10	REC5001593	435821	IMPULSOR IMPELLER
11	REC331188	331188	TÓRICA O-RING

2T  
STROKES

V4 / V6 "O" (1979-06) RATIO V4 2.25:1 (.44), V6 1.86:1 (.54)

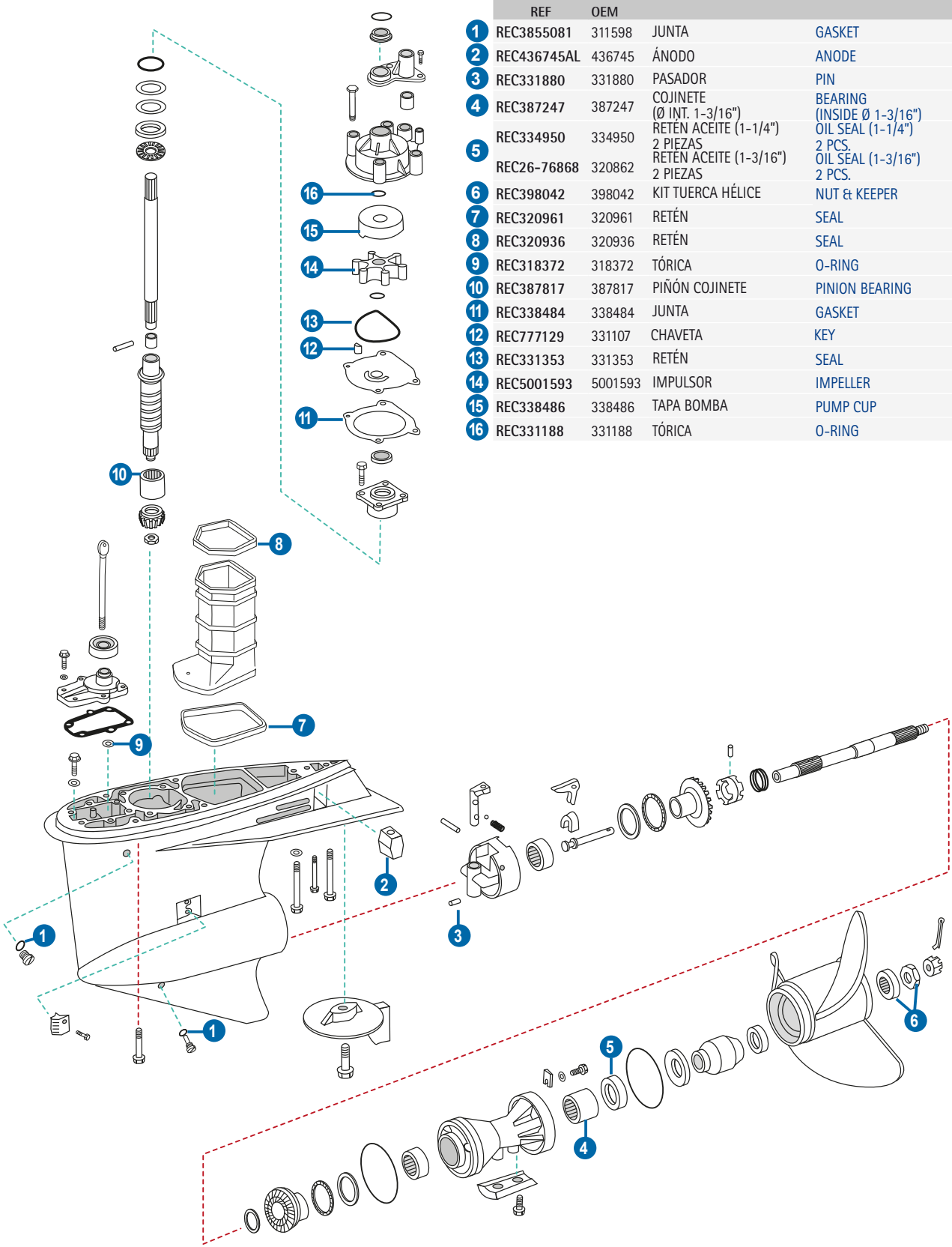

REF	OEM		
1	REC3855081 311598	JUNTA	GASKET
2	REC436745AL 436745	ÁNODO	ANODE
3	REC331880 331880	PASADOR	PIN
4	REC387247 387247	COJINETE (Ø INT. 1-3/16")	BEARING (INSIDE Ø 1-3/16")
5	REC334950 334950	RETÉN ACEITE (1-1/4")	OIL SEAL (1-1/4")
6	REC26-76868 320862	2 PIEZAS RETÉN ACEITE (1-3/16")	2 PCS. OIL SEAL (1-3/16")
7	REC398042 398042	KIT TUERCA HÉLICE	NUT & KEEPER
8	REC320961 320961	RETÉN	SEAL
9	REC320936 320936	RETÉN	SEAL
10	REC318372 318372	TÓRICA	O-RING
11	REC387817 387817	PIÑÓN COJINETE	PINION BEARING
12	REC338484 338484	JUNTA	GASKET
13	REC777129 331107	CHAVETA	KEY
14	REC331353 331353	RETÉN	SEAL
15	REC5001593 5001593	IMPULSOR	IMPELLER
16	REC338486 338486	TAPA BOMBA	PUMP CUP
17	REC331188 331188	TÓRICA	O-RING

JOHNSON EVINRUDE

RECMAR

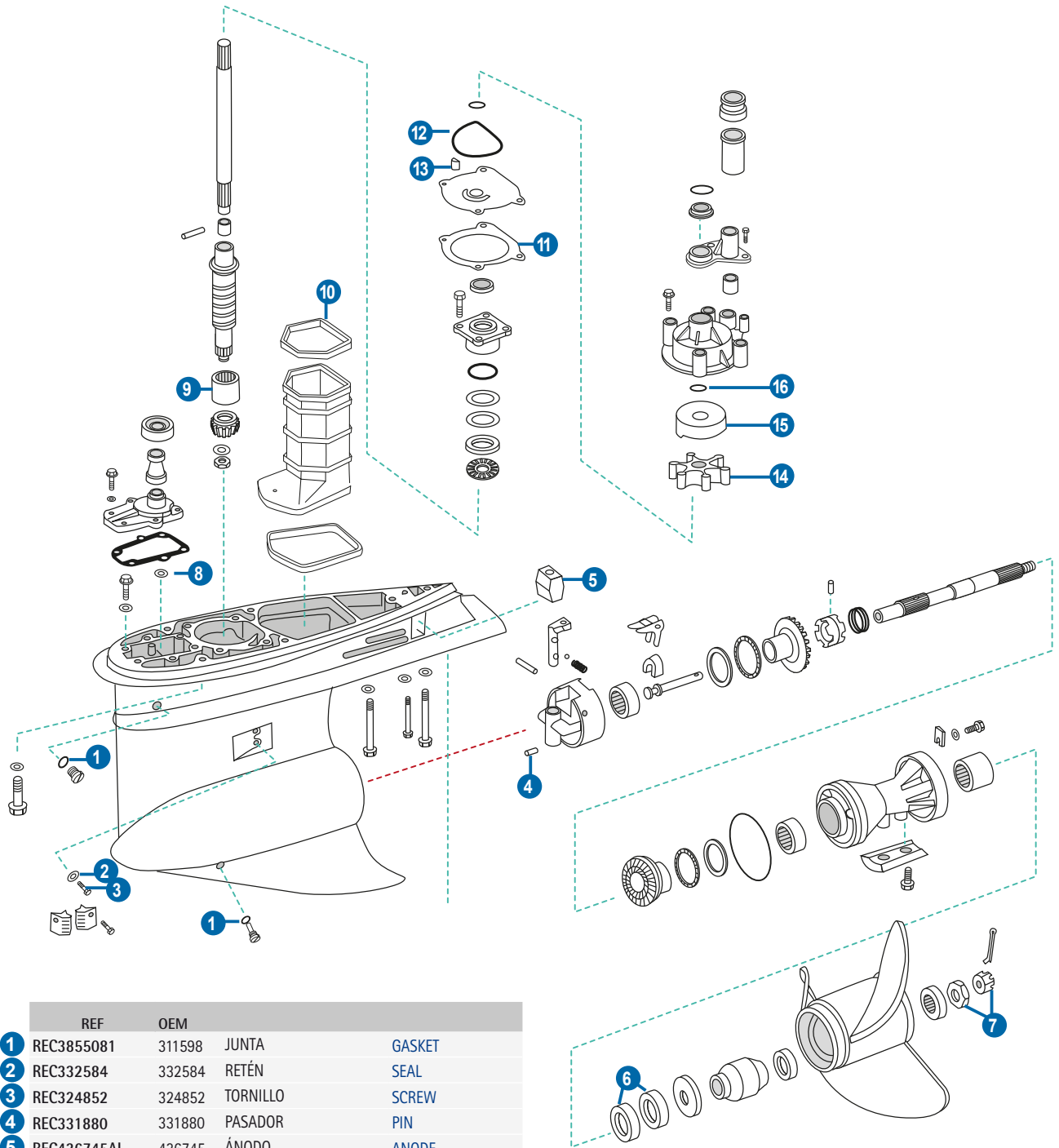

	REF	OEM		
1	REC3855081	311598	JUNTA	GASKET
2	REC332584	332584	RETÉN	SEAL
3	REC324852	324852	TORNILLO	SCREW
4	REC331880	331880	PASADOR	PIN
5	REC436745AL	436745	ÁNODO	ANODE
6	REC334950	334950	RETÉN ACEITE 2 PIEZAS	OIL SEAL - 2 PCS.
7	REC398042	398042	KIT TUERCA HÉLICE	NUT & KEEPER
8	REC318372	318372	TÓRICA	O-RING
9	REC387817	387817	COJINETE PIÑÓN	PINION BEARING
10	REC320936	320936	RETÉN	SEAL
11	REC338484	338484	JUNTA	GASKET
12	REC331353	331353	RETÉN	SEAL
13	REC331107	331107	CHAVETA	KEY
14	REC5001593	5001593	IMPULSOR	IMPELLER
15	REC338486	338486	TAPA BOMBA	PUMP CUP
16	REC331188	331188	TÓRICA	O-RING

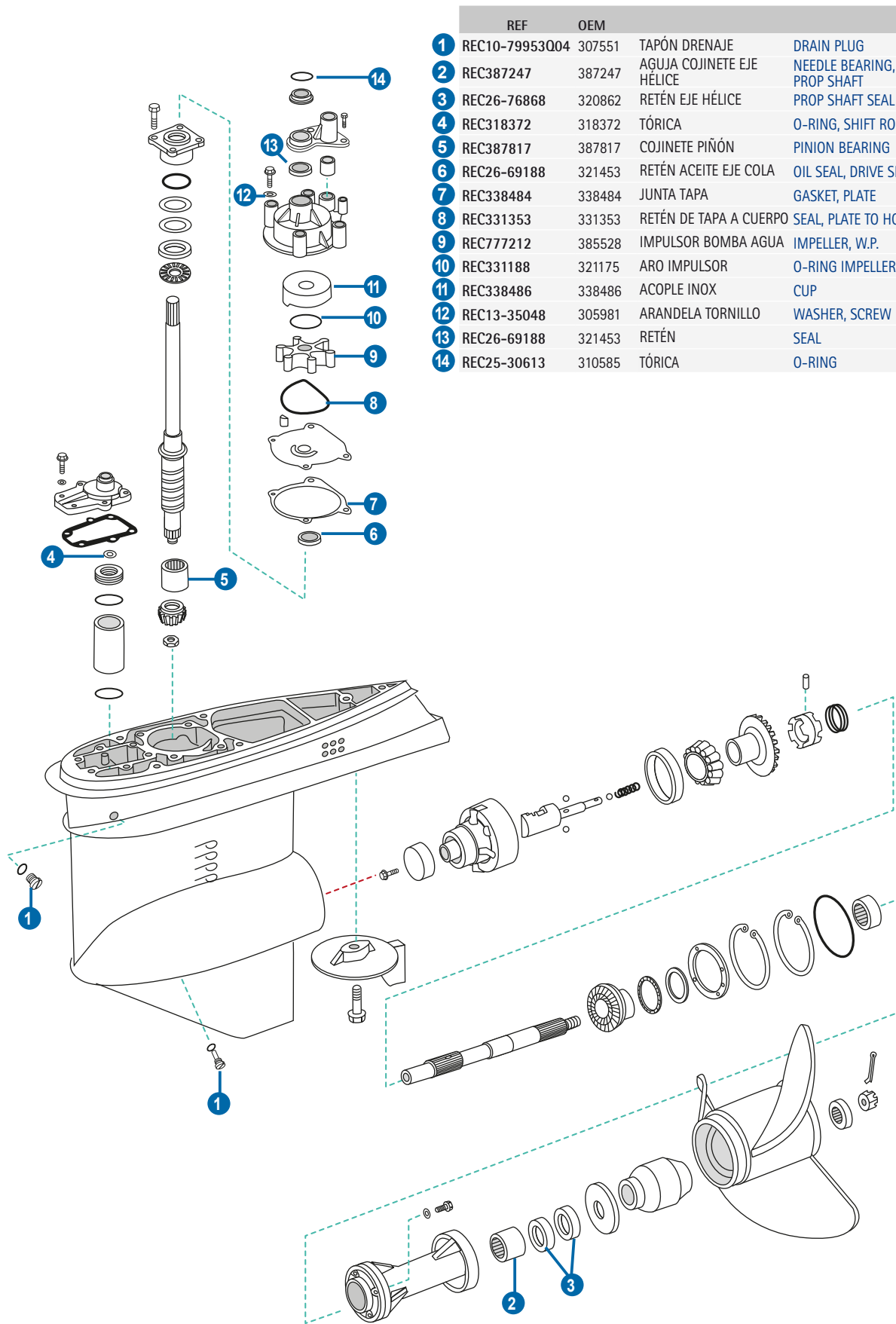



	REF	OEM		
1	REC10-79953Q04	307551	TAPÓN DRENAJE	DRAIN PLUG
2	REC387247	387247	AGUJA COJINETE EJE HÉLICE	NEEDLE BEARING, PROP SHAFT
3	REC26-76868	320862	RETÉN EJE HÉLICE	PROP SHAFT SEAL
4	REC318372	318372	TÓRICA	O-RING, SHIFT ROD
5	REC387817	387817	COJINETE PIÑÓN	PINION BEARING
6	REC26-69188	321453	RETÉN ACEITE EJE COLA	OIL SEAL, DRIVE SHAFT
7	REC338484	338484	JUNTA TAPA	GASKET, PLATE
8	REC331353	331353	RETÉN DE TAPA A CUERPO	SEAL, PLATE TO HOUSING
9	REC777212	385528	IMPULSOR BOMBA AGUA	IMPELLER, W.P.
10	REC331188	321175	ARO IMPULSOR	O-RING IMPELLER
11	REC338486	338486	ACOPLE INOX	CUP
12	REC13-35048	305981	ARANDELA TORNILLO	WASHER, SCREW
13	REC26-69188	321453	RETÉN	SEAL
14	REC25-30613	310585	TÓRICA	O-RING



# PIEZAS TRANSMISIÓN



# STERN DRIVE PARTS

## PIÑONES MARCHA AVANTE

## POSITIVE GEAR



REF	OEM	STROKES	STROKES	4T	2T	
REC57510-93910	5033191	J10 / J15 (2002-04)	✓			



REF	OEM	STROKES	STROKES	4T	2T	
REC57510-91J00	5034203 5030277 5031203	J 4, 5, 6 HP	✓			



REF	OEM	STROKES	STROKES	4T	2T	
REC57510-89J00	5032698 5032099 5036016	J/BJ 25, 30 HP	✓			



## PIÑONES MARCHA ATRÁS

## REVERSE GEAR

REF	OEM	STROKES	STROKES	4T	2T	
REC57521-96312	5032100	J/BJ 25, 30 HP	✓			



REF	OEM	STROKES	STROKES	4T	2T	
REC57521-93910	5033192	J10 / J15 (2002-04)	✓			



REF	OEM	STROKES	STROKES	4T	2T	
REC57521-91J00	5030278	J4, 5, 6 HP	✓			



REF	OEM	STROKES	STROKES	4T	2T	
REC57521-89J00	5032100	J/BJ 25, 30 HP	✓			



## PIÑONES ATAQUE

## INITIATIVE GEAR

REF	OEM	STROKES	STROKES	4T	2T	
REC57311-93910	5033190	J10 / J15 (2002-04)	✓			

REF	OEM	STROKES	STROKES	4T	2T	
REC57311-96311	5032098	BJ J25 / J30 (2000-07)	✓			

REF	OEM	STROKES	STROKES	4T	2T	
REC09263-20L04	5033003	J10 / J15 HP	✓			

REF	OEM	STROKES	STROKES	4T	2T	
REC57311-98600	5030276	J5 HP	✓			

## GRUESO PINONES ATAQUE



## SHIM INITIATIVE GEAR

REF	OEM	STROKES	STROKES	
REC09160-20044	5032969			0.7
REC09160-20041	5032985			1.0
REC09160-20042	5032967	J10 / J15 (2002-07)	✓	1.1
REC09160-20043	5032968			1.2



**ARANDELA  
PINONES ATAQUE**

**WASHER  
INITIATIVE GEAR**

REF	OEM		4T STROKES	2T STROKES	
REC09160-26015	5031232	E40 / J40 / BJ40 E50 / J50 / BJ50 (1999-06)	✓		26.2 x 42 x 4.0 mm
REC09160-21009	5032970	J10, J15 (2002-07)	✓		21 x 35 x 2.75 mm
REC09160-20027	5032966	J10, J15 (2002-07)	✓		



**SELECTOR**

**CLUTCHS DOGS**

REF	OEM		4T STROKES	2T STROKES
REC57621-91L10	5037515 5032102	J/BJ 25, 30 HP	✓	



REF	OEM		4T STROKES	2T STROKES
REC57621-94403	5036059 5031547	J40 / BJ40 J50 / BJ50 (2005-06)	✓	



**MUELLE PARA SELECTOR**



**SPRING CLUTCH**

REF	OEM	
REC09440-32008	5033037	J/BJ 10, 15 HP



REF	OEM	
REC09440-05027	5033034	J 10, 15 HP



REF	OEM		
REC09440-40002	5031286	REC57621-94403	J/BJ 40, 50 HP



**PIN**

**PIN**

REF	OEM	
REC57632-97L00	5030282	J4, 5, 6, 10, 15 HP



REF	OEM	
REC09202-05022	5031245	J/BJ 40, 50 HP



**PASADOR PARA SELECTOR**

**CLUTCH PIN**

REF	OEM	
REC57634-88L00	5031251	J/BJ 40, 50 HP



REF	OEM	
REC09209-08016	5031880	J/BJ 25, 30 HP



**VARILLA PARA SELECTOR**

**ROD PUSH**

REF	OEM	
REC57631-93901	5033196	J10, 15 HP



REF	OEM	
REC57631-95303	5031549	J/BJ 40, 50 HP
REC57631-96301	5032103	J/BJ 25, 30 HP



GUÍA COJINETES COLA

LOWER HOUSING BEARING GUIDE

	1	2	3
<b>2 CYL. LOOPCHARGED (1975-85) 40 - 60 HP</b>			
40	1984-85		
50	1975-85	REC31-32575T1	
55	1976-85		
60	1980-85		
<b>2 CYL. LOOPCHARGED (1986-05) 40 - 60 HP</b>			
40 Pequeño antiguo   Small Old	1986-88	REC31-32575T1	
50 Pequeño antiguo   Small Old	1986-88	REC31-32575T1	
55 Pequeño antiguo   Small Old	1986-88	REC31-32575T1	
60 Pequeño antiguo   Small Old	1986-88	REC31-32575T1	
<b>3 CYL. LOOPCHARGED (1973-01) 65 - 75 HP</b>			
70 Pequeño   Small	1974-01	REC31-32575T1	
75 Pequeño   Small	1979-85	REC31-32575T1	
<b>V4 (1984+)</b>			
80 "O"	1991-99	REC387817	
90 "O"	1984-90	REC387817	REC387247
90 "O"	1991-03	REC387817	
100 "O"	1984-90	REC387817	REC387247
100 "O"	1991-05	REC387817	
115 "O" Type	1984-90	REC387817	REC387247
115 "O" Type	1991	REC387817	
120 "O" Type	1985-90	REC387817	REC387247
120 "O" Type	1991-94	REC387817	
125 "O" Type	1989-90	REC387817	REC387247
125 "O" Type	1991-98	REC387817	
130 "O" Type	1995-00	REC387817	
135 "O" Type	2001	REC387817	
135 "M"	2002	REC387817	
140 "O"	1985-90	REC387817	REC387247
140 "O"	1991-94	REC387817	
<b>V6 (1979-90)</b>			
150	1979-90	REC387817	REC387247
<b>V6 (1991+)</b>			
150 "O"	1991	REC387817	

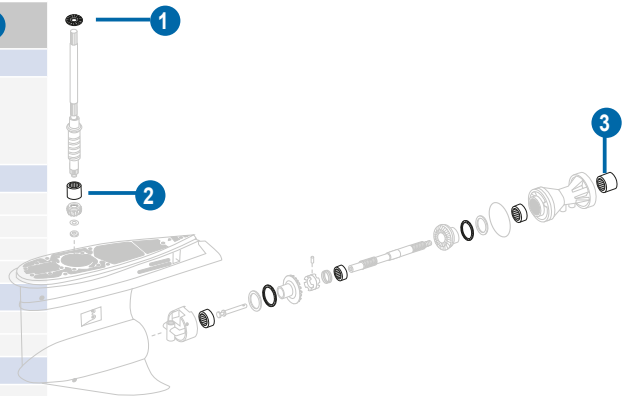

EJE TRANSMISIÓN INFERIOR. COJINETES

LOWER DRIVE SHAFT BEARING

REF	OEM	
REC09263-22L03	5031256	J/BJ 40, 50 HP
REC09263-20046	5031883	J/BJ 25, 30 HP



EJE TRANSMISIÓN SUPERIOR

UPPER DRIVE SHAFT

	REF	OEM	
J10 J15	2002-07	REC57100-93902	5033188 20"



EJE TRANSMISIÓN SUPERIOR. COJINETES

UPPER DRIVE SHAFT BEARING

REF	OEM	
REC08110-60020	5033299	J10, 15 HP



REF	OEM	
REC09265-17002	5031885	J/BJ 25 HP J 30 HP



EJE HÉLICE

PROP SHAFT

	REF	OEM
J10 J15	2002-07 4 T / Strokes	REC57610-93901 5033193



**CASQUILLO BASCULANTE**

**BUSH SWIVEL**

REF	OEM		2T STROKES	4T STROKES
REC43211-87JL0	5032058			✓
		E25, E30, E40, E50 J10, J15, J25, J30, J40, J50 BJ40, BJ50 (2000-07)		
REC43211-94401	5032058			✓
		J10, 15, 25, 30, 40, 50 HP		

REF	OEM		2T STROKES	4T STROKES
REC43711-97E11	5030852			✓
		J/BJ 60 --> 225 HP		



**COJINETE BOMBA DE ACEITE**

**OIL PUMP BEARING**

REF	OEM	
REC08110-60020	5033299	
		J/BJ 200, 225 HP



**FUELLES VARILLA DE CAMBIO**

**SHIFT, BELOW**

REF	OEM	
REC25222-93901	5030215	
		J4, 5, 6, 10, 15 HP



REF	OEM	
REC25222-96300	25222-96300	
		J25, 30 HP



**ARO TÓRICO  
VARILLA DE CAMBIO**

**SHIFT, O-RING**

REF	OEM		
REC09280-08005	5031260		J2 --> J50 HP 1,8 x 7.7 mm



REF	OEM		
REC09280-11001	5031261		BJ/J 40, 50 HP 2.4 x 10.8 mm



**TUERCA  
VARILLA DE CAMBIO**

**TURNBUCKE, CUTCH ROD**

REF	OEM		2T STROKES	4T STROKES
REC23311-95DL0	5031449			✓
		E25, E30, E40 J10, J15, J25, J30, J40, J50 BJ40, BJ50 (1999-07)		



**ARANDELA**

**WASHER**

REF	OEM
REC307161	0307161 307161



REF	OEM	
REC311598	311598	10 mm



**TUBO DRENAJE  
BOMBA DE AGUA**

**DRAIN WATER TUBE**



REF	OEM	
REC17453-93901	5033111 5035609	
		J10, 15 HP







TORNILLOS Y JUNTAS DE DRENAJE

DRAIN, SCREW AND GASKETS

REF	OEM		
REC09248-10008	5030094	4 --> 140 HP	10 x 7.2 mm

REF	OEM		
REC55128-93J10	5035151	J/BJ 200, 225 HP	



REF	OEM		
REC09168-10034	5034799	J/BJ 200, 225 HP	

REF	OEM		
REC59178-97J00	5037356	J2 - J30	

DIÁBOLO



DIABOLO



REF	OEM		
REC56120-93900	5032743	J10, 15 HP	

REF	OEM		
REC56120-96332-0EP	5034711	J/BJ 25, 30 HP	

ARO TÓRICO DEL DIÁBOLO



DIABOLO, O-RING



REF	OEM		
REC09280-57002	5033010	J10, 15 HP	3.5 x 65.2 mm



REF	OEM		
REC09280-75001	5031263	J/BJ 40, 50 HP	3.3 x 75 mm



COJINETE DE DIÁBOLO

DIABOLO BEARING

REF	OEM		
REC08110-60050	5033303	J10, 15 HP	

REF	OEM		
REC08113-60060	5032295	BJ/J 25, 30 HP	



REF	OEM		
REC09263-20047	5031884	J/BJ 25, 30 HP	

REF	OEM		
REC09263-22020	5031255	J/BJ 40, 50 HP	

COJINETE BOMBA DE AGUA

WATER PUMP BEARING

REF	OEM		
REC09263-25062	5031258	J/BJ 40, 50 HP	

REF	OEM		
REC09263-25025	5031257	J/BJ 40, 50 HP	

## KIT REPARACION COLA

## GEARCASE SEAL KIT

### CAMBIO MECÁNICO ESCAPE POR HELICE

REF	OEM	
REC396350	396350	9.9, 15 HP (-1974)



### MECHANICAL SHIFT THRU-PROP EXHAUST

REF	OEM	
REC396351	396351	2 Cyl. Crossflow 20, 25, 30, 35 HP



REF	OEM	
REC433550	433550	40, 48, 50 HP 2 cyl Loopcharged (1989-05)



REF	OEM
REC982949	0982949 982949



REF	OEM	
REC985612	0985612 985612	4 Cyl (1986-89) 2.3 L (1987-90)



REF	OEM		2T STROKES	4T STROKES
REC25700-88L00	5031456	E40 / J40 / BJ40 E50 / J50 / BJ50 (1999-06)		✓



### CAMBIO ELÉCTRICO/ HIDRÁULICO ESCAPE A TRAVÉS DE HELICE

REF	OEM	
REC43713	43713	55, 100, 125 HP V4 Crossflow (1971-72)



### ELECTRIC / HYDRAULIC SHIFT THRU-PROP-EXHAUST

### RETENES ACEITE

### OIL SEALS

REF	OEM	CALIBRE BORE (")	Ø EJE SHAFT Ø (mm)
REC321787	0321787 321787	2.5000	1.6250



GUÍA TÓRICAS

O-RING GUIDE

REF	OEM	ESPESOR TICKNESS	IN Ø	OUT Ø
REC25-35029	25-35029 35029 802231 882613	1/8	31/8	33/8
REC25-62705	25-62705 25-8M0204667 62705 8M0204667 F748342	1/16	3/4	7/8
REC301877	25-85594 85594	21/128	31/128	73/128
REC301967	301967	3/32	13/16	1
REC302537	302537	3/32	13/8	19/16
REC304174	0304174 0508507 304174	1/16	1/2	5/8
REC305123	0305123 0322119 0508986 305123	1/8	33/4	4
REC302035	25-48452	1/16	7/16	9/16
REC310584	0310584 310584	1/8	3/4	1
REC313175	313175	1/8	43/4	5
REC313754	0313754 313754	3/32	21/16	21/16
REC314491	0314491 314491	1/16	1	11/8

REF	OEM	ESPESOR TICKNESS	IN Ø	OUT Ø
REC314728	0354731 314728 354731	3/32	21/8	25/16
REC318717	0318717 318717	3/16	11/2	1 7/8
REC319085	0319085 319085	3/16	11/8	11/2
REC326649	0326649 0508493 0509009 0910582 326649 329380 909047	3/32	5/8	13/16
REC326849	0326849 0509009 326849	1/8	41/4	41/2
REC339543	0339543 0508691 303059 339543	3/32	1/2	11/16
REC3852928	25-26855 26855	1/8	15/8	17/8
REC553126	25-31305 31305	1/8	31/4	31/2
REC909048	802149	3/32	1/2	11/16
REC909139	802149	1/8	1	11/4
REC909140	25-58390 58390 802151	1/16	11/16	113/16
REC910238	802383	1/8	51/4	51/2



## PIEZAS HÉLICE

## PROP PARTS

### TUERCA DE HÉLICE

### PROPELLER NUT

REF	OEM	
REC09141-12005	5032950	J10, 15 HP





REF	OEM	
REC90171-18M04	09141-18005	40 --> 250 HP



### PASADOR

### PIN

REF	OEM	
REC91490-30025	5030087	4 --> 225 HP
REC09204-02004	5032996	J10, 15 HP
PAGB/T91-1.6X12	5037363	J10, 15 HP
REC18-32665	5037373	J10, 15 HP
REC18-32665	302804	
REC309955	0309955	
REC309955	309955	
REC320785	0320785	
REC320785	320785	

REF	OEM	
REC314502	18-82132M	
	18-89961	
	802028	
	89961	
	F1027	



### SEPARADOR DE HÉLICE

### PROPELLER WASHER

REF	OEM	
REC57632-94J00	5033197	J10, 15 HP



REF	OEM	
REC57633-93901	5033198	J10, 15 HP



REF	OEM	
REC315810	0315810 315810	7/8"



### PASADOR DE HÉLICE

### PROPELLER PIN

REF	OEM	
REC09202-04002	5030084	J2, 4, 5 HP



### KIT CIERRE HÉLICE SIN ARANDELA

### PROP NUT KITS WITHOUT WASHER

REF	OEM	
REC398042	398042	3/4" NF 16



### TUBO GUÍA

### WATER TUBE BRACKET

REF	OEM
REC315838	0315838 315838



OEM	REF	OEM	REF	OEM	REF	OEM	REF				
26855	REC3852928	134	312932	REC93-06511	62	325040	REC325040	117	338879	REC338879	53
31305	REC553126	134	313065	REC802243	100	325092	REC325092	101	338880	REC338880	56
35029	REC25-35029	134	313175	REC313175	134	325260	REC325260	101	338884	REC338884	56
43577	REC439078	56	313416	REC3852120	76	325273	REC802288	98	338886	REC338886	56
43713	REC43713	133	313446	REC967344	80-123-124	325537	REC325537	120	339044	REC339044	76
58390	REC909140	134	313754	REC313754	134	325721	REC325721	99	339543	REC339543	134
62705	REC25-62705	134	313782	REC313782	97	326260	REC0326260	101	341732	REC341732	121-122-123
85594	REC301877	134	313893	REC338518	80	326264	REC0326264	100			78-79-121-122-123
115742	REC115742	66-68	313992	REC26-419533	78	326649	REC326649	134	342786	REC342786	121-122-123
173029	REC173029	88	314082	REC314082	93	326849	REC326849	134			
173029	REC173029AL	88	314491	REC314491	134	326926	REC326926	101	343512	REC343512	56
175974	REC5005801	63	314728	REC314728	134	327031	REC327031	78-79	343863	REC343863	100
176288	REC176288	63	315232	REC315232	57	327674	REC327674	101	344470	REC344470	78
176333	REC176333	74	315788	REC315788	122	327707	REC327707	101	351018	REC351018	99
176334	REC176334	74	315810	REC315810	135	327795	REC335359	97	354016	REC40145	50
176335	REC0176335	74	315837	REC315837	82	328603	REC328603	94	354731	REC314728	134
176335	REC176335	74	315838	REC315838	135	328725	REC328725	90	355911	REC0355911	56
176339	REC176339	73	318358	REC318358	98	328751	REC328751	82	355964	REC355964	88
176340	REC0176340	73				328753	REC328753	120	355964	REC355964AL	88
176340	REC176340	73	318372	REC318372	80-121-122-123-124-125-126-127	328753	REC328753	120	357507	REC357507	88
176341	REC176341	73				329103	REC329103	98	357507	REC357507AL	88
176342	REC0176342	73	318717	REC318717	134	329319	REC0329319	76	360941	REC40165	50
176342	REC176342	73	318924	REC318924	101	329380	REC326649	134	375638	REC775518	77
176349	REC423-6349	74	318925	REC318925	100	329381	REC3852045	80	375919	REC396514	55
176408	REC0176408	74	318932	REC318932	101	329390	REC329390	119	377139	REC377139	95-96
202893	REC25-48171	80	318972	REC318972	78-79-118	329419	REC329419	97	377230	REC777213	77-122
203130	REC203130	98-99	319085	REC319085	134	329828	REC329828	99	378674	REC0586278	60
203698	REC300-01744	63	319126	REC302325	86	329830	REC329830	76	378895	REC396521	55
277432	REC0586278	60	319332	REC319332	101	329836	REC329836	98	379091	REC0586278	60
278232	REC0586278	60	319661	REC0319661	101	329920	REC329920	101	379091	REC0586278	60
300611	REC300611	77-78-118	319662	REC0319662	80	329922	REC329922	78	379312	REC396522	55
301967	REC301967	134	320303	REC925093	122	329923	REC329923	78-79-94	379818	REC0586278	60
302325	REC302325	86	320775	REC320775	82	330137	REC330137	78-79-123-124	380095	REC0586180	64
302337	REC25-33145	80	320776	REC320776	82	330525	REC300-01633	63	380139	REC0586278	60
302497	REC302497	117-118-119-120	320785	REC320785	135	330527	REC93-08665	62	380238	REC0586278	60
302537	REC302537	134	320862	REC26-76868	78-79-125-127	330560	REC330560	81	381864	REC0586278	60
302540	REC125017	80	320936	REC320936	100-124-125-126	330619	REC344470	78	382049	REC439071	56
302588	REC302588	80-122	320943	REC320943	83	330621	REC0330621	99	382547	REC765431	77-123
302804	REC18-32665	135	320961	REC320961	100-124-125	330621	REC0330621	99	383052	REC439071	56
302873	REC302325	86	320981	REC320981	83	331107	REC331107	77-78-126	383067	REC439071	56
303059	REC339543	134	321008	REC321008	83	331107	REC777129	125	383622	REC0586180	64
303067	REC3852045	80	321120	REC321120	76	331188	REC331188	121-124-125-126	383691	REC0586281	61
303191	REC25-62702	80	321175	REC321175	127	331353	REC331353	124-125-126-127	384087	REC384087	81
303339	REC303339	84	321188	REC321188	83	331880	REC331880	123-125-126	384777	REC0586281	61
303347	REC303347	80-120	321453	REC26-69188	78-79-120-127	331901	REC331901	78	384799	REC0586957	62
303360	REC25-35027	80	321459	REC321459	78-79-119	331980	REC331980	86	385072	REC385072	77
303615	REC303615	53	321466	REC321466	78	332010	REC802307	98	385175	REC31-32575T1	122
304174	REC304174	134	321466	REC321466	122	332205	REC342786	78	385389	REC385389	64
305123	REC305123	134	321467	REC321467	78-79-94-121-122	332261	REC332261	78-79-120-121-122	385401	REC0586278	60
305242	REC305242	80-117	321479	REC0321479	101	332584	REC332584	121-122-126	385528	REC777212	127
305762	REC305762	83	321480	REC321480	78-79-118	332584	REC3852045	123	385529	REC0586283	61
305981	REC13-35048	127	321481	REC321481	118	332584	REC3852045	123	386084	REC386084	77-118
306643	REC306643	90	321497	REC321497	102	333008	REC333008	102	386149	REC396514	55
307133	REC307133	99-101	321692	REC435957	84	333758	REC333758	121	386279	REC386918	97
307161	REC307161	131	321787	REC321787	133	334897	REC334897	77-78-121-123	386465	REC0586283	61
			321886	REC321886	76	334950	REC321481	78	386591	REC0586278	60
307551	REC10-79953Q04	117-118-119-120-122-123-127	321886	REC321886	76	334950	REC334950	125-126	386597	REC0586278	60
			321895	REC321895	78-79-84	334950	REC334950	125-126	386657	REC0586281	61
308627	REC308627	118	321895	REC321895	78-79-120	335359	REC335359	97	387094	REC0778292	62
308876	REC308876	80	321928	REC321928	78-79-120	335359	REC335359	97	387247	REC387247	125-127-130
308928	REC308928	78	321932	REC321932	76	336308	REC336308	100	387277	REC0584107	69
309004	REC309004	119	322119	REC305123	134	336493	REC336493	117	387361	REC763735	77
309243	REC309243	87	322494	REC322494	117	336530	REC336530	121-123	387817	REC387817	125-126-127-130
309955	REC309955	135	323327	REC0323327	57	336947	REC336947	76	388344	REC388344	95-96
310058	REC27-62386001	76	323338	REC323338	102	338222	REC338222	98	388344	REC388344	
310327	REC25-30224	121	323653	REC93-06522	62	338484	REC338484	124-125-126-127	389380	REC0586283	61
310414	REC310414	80	324334	REC324334	87	338485	REC338485	83	389398	REC0586180	64
310584	REC310584	134	324430	REC331980	86	338486	REC338486	82-87-125-126-127	389493	REC0586180	64
310585	REC25-30613	80-127	324449	REC324449	119	338518	REC338518	80-120	389576	REC389576	77
310967	REC25-30613	80	324639	REC324639	78-79-117	338534	REC93-06522	62	389577	REC389577	81-87-117
311598	REC12-191833	123	324641	REC324641	82-87-117	338632	REC338632	76	389589	REC777129	77
311598	REC311598	131	324717	REC324717	99	338635	REC338635	88	389642	REC777212	77
			324852	REC324852	121-126	338635	REC338635	88	389954	REC0586283	61
311598	REC3855081	120-121-122-124-125-126	324937	REC324937	100	338635	REC338635AL	88	389999	REC389999	88
			324960	REC324960	86	338742	REC338742	88	389999AL	REC389999AL	88
312456	REC35-49088A2	50	324981	REC324981	121-123	338742	REC338742AL	88	390286	REC390286	77
						338876	REC338876	53	390509	REC390509	97
									390770	REC439077	85

OEM	REF	OEM	REF	OEM	REF	OEM	REF				
391170	REC391170	97	433935	REC0767407	77	582901	REC0582901	66	586842	REC3853839	64
391264	REC0393988	69	433941	REC802133	98	583122	REC0583320	67	586890	REC0586957	62
391305	REC439072	56	434424	REC434424	77	583167	REC0586697	66	586897	REC0586957	62
391511	REC0586957	62	434495	REC5005376	69	583168	REC0586697	66	586957	REC0586957	62
391554	REC0586283	61	434496	REC5005376	69	583169	REC0586697	66	587012	REC587012	59
391735	REC0586281	61	434839	REC434839	52	583170	REC0586697	66	678882	REC396521	55
392061	REC396701	56	434841	REC6F5-12411-03	75	583175	REC0586697	66	763763	REC0763763	67
392123	REC392123	88	434844	REC434844	95	583320	REC0583320	67	763764	REC0763764	67
392123	REC392123AL	88	434888	REC439076	56	583340	REC0763767	67	763765	REC0763765	67
392133	REC0586278	60	435027	REC338485	83	583380	REC0582452	66	763767	REC0763767	67
392462	REC392462	88	435230	REC0435230	56	583410	REC0763769	67	763769	REC0763769	67
392462	REC392462AL	88	435442	REC438996	56	583415	REC0763765	67	763779	REC0763779	67
392550	REC439076	56	435443	REC439076	56	583482	REC0586279	61	764666	REC764666	73
392567	REC802133	98	435491	REC435491	75	583529	REC0585195	66	765553	REC433190	50
392615	REC802133	98	435532	REC5005254	70	583536	REC0763767	67	765591	REC438559	53
393088	REC393088	54	435676	REC439078	56	583604	REC0586697	66	766419	REC396514	55
393103	REC393103	54	435678	REC439078	56	583710	REC0763764	67	777693	REC0778292	62
393259	REC0393988	69	435752	REC439078	56	583737	REC584561	58	777702	REC584561	64
393570	REC0778994	62	435821	REC5001593	77-124	583740	REC0583740	58-59	777784	REC0584107	69
393630	REC393630	85-87-120	436137	REC389576	77-117	583748	REC0583748	67-68	778162	REC65L-24563-00	51
393632	REC393632	81-87-120	436195	REC878904	75	583773	REC0584028	66	778209	REC3853839	64
393988	REC0393988	69	436254	REC436254	97	584027	REC0584028	66	778885	REC16510-87J00	52
394176	REC0393988	69				584028	REC0584028	66	778886	REC16510-90J00	52
394411	REC394411	76	436745	REC436745AL	89-122-124-125-126	584107	REC0584107	69	778887	REC16510-82703	52
394462	REC394462	94	437088	REC31-17514A2	95	584109	REC0763759	67	778888	REC16510-93J00	52
394546	REC802113	98-99	437090	REC437090	75	584204	REC0585195	66	778991	REC0585059	60
394711	REC394711	85	437801	REC5005254	70	584287	REC0763765	67	778992	REC0778292	62
394930	REC394930	97	438529	REC5005376	69	584292	REC0763764	67	778994	REC0778994	62
395207	REC0778292	62	438531	REC5005376	69	584348	REC584348	59	802149	REC0909048	134
395270	REC395270	85	438555	REC1399-07353	53	584416	REC3857533	64	802149	REC0909139	134
395289	REC395289	77-119-120	438556	REC1399-07352	53	584477	REC0584477	58-59	802151	REC0909140	134
395419	REC0586180	64	438559	REC438559	53	584560	REC0763763	67	802208	REC303339	84
395460	REC93-08668	62	438562	REC1399-07351	53	584561	REC584561	58	802231	REC25-35029	134
395627	REC395627	95-96	438616	REC438616	54	584580	REC584580	64	802302	REC338886	56
395861	REC395861	94	438786	REC5005254	70	584608	REC0586275	60	802310	REC338884	56
396041	REC878763	95	438878	REC0586287	61	584632	REC0502890	58	802383	REC910238	134
396141	REC0586697	66	438904	REC39390	98	584641	REC0586271	66	879010	REC338884	56
396161	REC0500581	56	438996	REC438996	56	584643	REC0763779	67	882613	REC25-35029	134
396235	REC0586957	62	439071	REC439071	56	584767	REC5001344	67	908194	REC908194	80
396350	REC396350	133	439072	REC439072	56	584768	REC5001344	67	909047	REC326649	134
396351	REC396351	120-133	439076	REC439076	56	584783	REC0586798	66-68	910582	REC326649	134
396377	REC396377	97	439077	REC439077	85	584799	REC0586957	62	911685	REC911685	78
396514	REC396514	55	439078	REC439078	56	584890	REC300-03588	65	912157	REC912157	82
396521	REC396521	55	439347	REC4428	53	584908	REC5001344	67	916058	REC3853655	56
396522	REC396522	55	439347	REC5004428	53	584980	REC0586284	61	980801	REC3853839	78
396701	REC396701	56	439542	REC0439542	56	584981	REC0763759	67	981703	REC3853839	64
396725	REC396725	77-123	439937	REC5005254	70	585001	REC300-03587	65	982189	REC3853839	64
396809	REC777214	77-122	500581	REC0500581	56	585051	REC0586283	61	982949	REC982949	133
396987	REC396987	76	502890	REC0502890	58	585056	REC0586279	61	983019	REC0393988	69
397004	REC0397004	56	508493	REC326649	134	585057	REC0586283	61	983298	REC983298	81
397023	REC0586957	62	508507	REC304174	134	585058	REC0586281	61	985064	REC3853839	64
397839	REC1399-07350	52	508691	REC339543	134	585059	REC0585059	60	985612	REC985612	133
398042	REC398042	125-126-135	508986	REC305123	134	585060	REC0778994	62	3214794	REC321794	102
398047	REC398047	98	509009	REC326649	134	585061	REC0586278	60	3234323	REC0324323	100
398051	REC398051	94	509009	REC326849	134	585062	REC0778292	62	3852548	REC3852548	78
398319	REC40135	50	509128	REC40155	50	585074	REC5001344	67	3852565	REC25-25439	80
398327	REC40135	50	509219	REC8M0058226	64	585081	REC0585081	65	4359073	REC439074	56
398327	REC40155	50	530429	PAGB/T848-6	105	585195	REC0585195	66	5000309	REC324937	100
398452	REC439072	56	534545	REC0554545	80-120	585196	REC0586283	61	5000800	REC4428	53
398453	REC439072	56	580256	REC0580256	59	585197	REC0586281	61	5000800	REC5004428	53
398514	REC398514	54	581295	REC3857533	64	585995	REC0586271	66	5001593	REC5001593	77-125-126
398526	REC439076	56	581407	REC0502880	58-59	586147	REC3857533	64	5001594	REC5001594	86-87
398529	REC398529	95-96	581419	REC0581419	60	586180	REC0586180	64	5001595	REC5001595	86-87
398532	REC439071	56	581778	REC581778	65	586224	REC3857533	64	5004428	REC4428	53
398729	REC396701	56	582047	REC0584107	69	586257	REC0586287	61	5004428	REC5004428	53
398873	REC398873	88	582048	REC0584107	69	586271	REC0586271	66	5005254	REC5005254	70
398873	REC398873AL	88	582155	REC0584107	69	586275	REC0586275	60	5005266	REC5007335	51
431870	REC431870	97	582160	REC0502890	58	586278	REC0586278	60	5005374	REC5005376	69
432230	REC432230	63	582285	REC0586697	66	586279	REC0586279	61	5005440	REC6F5-12411-03	75
432397	REC432397	88	582285	REC0586697	66	586281	REC0586281	61	5005801	REC5005801	63
432397	REC432397AL	88	582366	REC584561	58	586282	REC0586283	61	5005817	REC5006319	70
432941	REC432941	77-121	582453	REC0582452	66	586283	REC0586283	61	5005822	REC5005831	69
432955	REC432955	86-87	582472	REC3857533	64	586284	REC0586284	61	5005831	REC5005831	69
432962	REC432962	54	582473	REC3857533	64	586285	REC0778994	62	5005838	REC5006319	70
433190	REC433190	50	582474	REC0582901	66	586288	REC0778292	62	5005875	REC5005831	69
433226	REC0433226	69	582508	REC0586697	66	586289	REC0586957	62	5006063	REC5006063	53
433325	REC0433325	56	582508	REC0582508	58-59	586411	REC0586957	62	5006180	REC5006180	71
433458	REC433458	88	582708	REC0586180	64	586730	REC3853839	64	5006181	REC5006181	71
433458	REC433458AL	88	582757	REC0586697	66	586731	REC0586957	62	5006182	REC5006182	72
433550	REC433550	133	582864	REC0582901	66	586767	REC0586767	64	5006184	REC5006184	72
			582880	REC0586697	66	586774	REC586774	64			

OEM	REF		OEM	REF		OEM	REF		OEM	REF	
5006186	REC5006186	72	5030725	REC17472-87E10	81-114-115	5032058	REC43211-94401	131	5033371	PAF4-04090000	52
5006319	REC5006319	70	5030742	REC17670-93962	75	5032091	REC55125-91L01AL	109	5033372	REC15170-91J00	54
5006358	REC5006358	76	5030780	REC31100-87J00	61	5032098	REC57311-96311	128	5033381	REC17472-91J00	84
5006373	REC321120	73	5030783	REC89-825096T01	64	5032098	REC57311-96320	109-111	5033385	REC17670-91J01	75
5006479	REC5005831	69	5030795	REC32800-92E20	65	5032099	REC57510-89J00	128	5033481	REC09283-25076	102
5006561	REC5006561	91	5030852	REC43711-97E11	131	5032100	REC57521-89J00	109-111-128	5033539	REC16510-90J00	52
5006655	REC435546	77	5030870	REC48630-94900	70	5032100	REC57521-96312	128	5033541	REC17400-90J20	86-115
5007326	REC5007335	51	5031114	REC15626-99E00	54	5032101	REC57610-96311	109-111	5033542	REC17461-90J01	77-115-116
5007485	REC5007485	73	5031116	REC34801-99E04	70	5032102	REC57621-91L10	129	5033632	REC09420-05009	78
5007494	REC5007497	63	5031175	REC17670-93962	75	5032103	REC57631-96301	111-129	5033639	REC11141-90J01	92
5007497	REC5007497	74	5031196	REC17471-98601	83	5032150	REC65720-986L0	50	5033649	REC11489-90J00	100
5007582	REC5007582	88	5031203	REC57510-91J00	128	5032167	REC25700-95D01	85	5033702	REC63P-13907-03	53
5009214	REC586774	64	5031215	PAGB/T5783-M8X16	111-113	5032191	REC55125-91L01AL	111	5033704	REC15440-90J00	51
5009220	REC5009220	88	5031216	PAGB/T5783-M8X30	107-113	5032238	REC15410-98500	50	5033706	REC15626-90J00	54
5009220	REC5009220AL	88	5031232	REC09160-26015	113-129	5032295	REC08113-60060	109-111-132	5033708	REC15710-65D00	55
5030034	REC09116-06094	90-107-109-113-116	5031245	REC09202-05022	129	5032323	REC15410-87J10	50	5033721	REC67F-12411-01	75
5030035	PAGB/T5783-M6X16	105	5031251	REC57634-88L00	113-129	5032428	REC11413-87J00	93	5033722	REC17670-90J10	75
5030035	REC09116-06094	90	5031255	REC09263-22020	113-132	5032502	REC09116-06121	90	5033780	REC18590-72F21	57
5030036	REC09116-06094	90	5031256	REC09263-22L03	113-130	5032615	REC32800-87J10	65	5033799	REC31100-90J01	61
5030037	PAGB/T5787-M6X20	111	5031257	REC09263-25025	113-132	5032615	REC32800-87J10	65	5033820	REC32800-90J00	66
5030038	PAGB/T5783-M6X16	114	5031258	REC09263-25062	113-132	5032617	REC63P-13907-03	53	5033838	REC38100-96J00	69
5030051	REC95380-06700	105-107-109-113	5031260	REC09280-08005	131	5032670	REC5031482	69	5033919	REC16510-82703	52
5030051	PAGB/T6184-2000	111	5031261	REC09280-11001	131	5032689	REC57510-89J00	109	5033935	REC48630-92J00	70
5030068	PAGB/T848-6	111	5031263	REC09280-75001	109-113-132	5032693	REC15710-66D00	55	5034203	REC57510-91J00	105-128
5030068	PAGB/T93-6	111	5031264	REC09282-17005	102-113	5032698	REC57510-89J00	111-128	5034255	REC32800-94620	64
		107-113	5031266	REC09282-17009	102-113	5032732	REC33410-94400-000	58	5034323	REC17400-98661	85-105
		102-105-107-109-111-113-114-115	5031270	REC09289-22007	102-113	5032743	REC56120-93900	107-132	5034353	REC11141-87J02	92
5030071	REC09168-10022	107-109-111-113-114-115	5031281	REC09420-04006	102-113	5032766	PAGB/T5783-M8X55	107	5034354	REC11400-87804	92
5030084	REC09202-04002	113-135	5031286	REC09440-40002	113-129	5032786	REC33220-76G02	58	5034462	REC11489-93E11	100
5030087	REC91490-30025	105-109-111-113-114-115-135	5031293	REC11141-87J02	91-92	5032801	REC56120-94321-OEP	113	5034526	REC38100-96J00	69
		114-115-135	5031297	REC11189-87J00	91-92	5032802	REC56130-94413-OEP	82-113	5034606	REC38410-93J12	70
		105-107-109-111-113-114-115-132	5031302	REC11400-87804	92	5032929	REC55125-90J01AL	114-115	5034627	REC38100-96J00	69
5030094	REC09248-10008	102-105	5031304	REC11413-87J00	91-93	5032930	REC55321-90J01AL	89-114-115	5034644	REC11141-92J01	92
5030107	REC09282-10008	102	5031306	REC11433-87J00	91-93	5032945	PAGB/T820-M6X20	107	5034651	REC17471-92J00	83-114
5030108	REC09282-12008	102	5031307	REC11433-87J00	91-93	5032950	REC09141-12005	135	5034680	REC32800-89J11	65
5030109	REC09283-10003	102	5031307	REC11489-87J00	91-100	5032966	REC09160-20027	129	5034711	REC56120-96332-OEP	109-111-132
5030110	REC09283-20018	102	5031390	REC13421-87J00	91-94	5032967	REC09160-20042	107-128	5034757	REC51211-90J10	93
5030111	REC09283-20045	102	5031392	REC13650-52G00	57	5032968	REC09160-20043	107-128	5034799	REC09168-10034	116-132
5030137	REC09420-03002	77-78-105	5031400	REC15410-87J00	51	5032969	REC09160-20044	107-128	5034842	REC09420-05009	78-115-116
5030181	REC15170-98110	54	5031403	REC15710-87J00	55	5032970	REC09160-21009	107-128	5034878	REC11489-93J00	100
5030183	REC16910-GB2-005	51	5031411	REC16510-87J00	52	5032985	REC09160-20041	107-128	5034959	REC13119-93J00	101
5030188	REC17461-98503	77-105	5031417	REC17461-96312	77-109-111-113	5032987	REC09168-12017	52	5034984	REC15410-93J00	50
5030189	REC17471-98601	83	5031418	REC17471-94401	83-111	5032996	REC09204-02004	135	5034985	REC15440-93J00	51
5030190	REC17472-98611	84	5031419	REC17472-96303	113	5033003	REC09263-20L04	107-128	5034995	REC69J-24501-10	51
5030215	REC25222-93901	131	5031426	REC17616-87J00	91-93	5033009	REC09280-54001	52	5035010	REC15710-93J00	55
5030225	REC37830-89E03	63	5031430	REC17685-87D10	91-93	5033010	REC09280-57002	107-132	5035036	REC17400-93J01	86
5030267	REC5030267	88	5031449	REC23311-95DLO	131	5033011	REC09282-12010	102	5035036	REC17400-93J01	86
5030267	REC5030267A	88	5031456	REC25700-88L00	113-133	5033014	REC09289-12003	107	5035036	REC17400-96J03	116
5030276	REC5030267A	88	5031468	REC33220-76G02	58	5033015	REC09289-17006	102-107	5035038	REC17413-96J01	116
5030276	REC57311-98600	105-128	5031474	REC34801-99E04	70	5033027	REC09380-15001	84-107	5035039	REC17416-93J00	82
5030277	REC57510-91J00	128	5031481	REC37820-92E03	63	5033034	REC09440-05027	107-129	5035039	REC17416-96J00	116
5030278	REC57521-91J00	105-128	5031482	REC38100-87J00	69	5033037	REC09440-32008	107-129	5035041	REC17471-92J02	83-116
5030282	REC57632-97L00	105-129	5031482	REC5031482	69	5033046	REC11141-93E20	92	5035042	REC17472-93J00	84-116
5030338	PAGB/T5783-M6X12	115	5031523	REC51211-87J00	91-93	5033070	REC12761-93ELO	99	5035054	REC17913-93J00	77
5030352	REC17400-98652	85	5031535	REC55122-94400	84	5033086	REC13250-95D01	55	5035055	REC17914-93J00	77
5030356	REC32800-95D01	65	5031535	REC55122-94400	84	5033102,7	REC16510-05240	52	5035078	REC31100-96J02	62
5030391	PAGB/T5283-M6X25	105	5031536	REC55125-95500AL	113	5033106	REC17400-93951	85-107	5035099	REC34801-93J03	70
5030391	REC09116-06121	90-109-111	5031546	REC57610-94402	113	5033107	REC17411-93901	81-107	5035113	REC38100-96J00	69
5030394	PAGB/T5787-M6X30	109	5031547	REC57621-94403	129	5033109	REC17450-93921	107	5035138	REC51211-93J00	93
5030398	PAGB/T5783-M8X25	115	5031549	REC57631-95303	113-129	5033110	REC17452-93910	84-107	5035150	REC55125-90J01AL	116
5030405	PAGB/T818-M4X30	114	5031705	REC55321-87J01AL	89-90-105	5033111	REC17453-93901	107-131	5035151	REC55128-93J10	116-132
5030406	PAGB/T8.8-2000	115	5031731	REC17400-87E04	86-114	5033112	REC17461-93903	77-107	5035305	REC09280-22019	90
5030409	PAGB/T818-M6X10	107	5031744	REC17400-96403	86-111-113	5033113	REC09420-03005	78	5035412	REC18137-52D00	57
5030415	PAGB/T889.1-M4	114	5031758	REC17670-94402	75	5033113	REC17462-93990	77-78-107	5035513	REC38100-96J00	69
5030422	REC90171-18M04	113-114-115-116	5031822	PAGB/T5787-1986	105	5033114	REC17471-93902	83-107	5035603	REC17472-93911	84-107
5030429	PAGB/T848-6	109	5031827	REC90179-08M06	109-111	5033167	REC55320-98400AL	107	5035609	REC17453-93901	131
5030465	REC09168-12012	52	5031863	REC09168-12017	52	5033188	REC57100-93902	107	5035695	REC65L-24563-00	51
5030508	REC93606-12019	115-116	5031880	REC09209-08016	109-111-129	5033190	REC57311-93910	107-128	5035703	REC16510-93J00	52
5030511	PAF25-00000014	115-116	5031883	REC09263-20046	109-111-130	5033191	REC57510-93910	107-128	5035786	REC55320-95311AL	116
5030623	REC11265-87E10	90-91	5031884	REC09263-20047	109-111-132	5033192	REC57521-93910	107-128	5035971	REC11142-93J10	92
5030660	REC12761-72F00	99	5031885	REC09265-17002	109-111-130	5033193	REC57610-93901	107-130	5035974	REC15410-87J30	50
5030687	REC13650-56B00	57	5031890	REC925093	111	5033196	REC57631-93901	107-129	5036016	REC57510-89J00	128
5030700	REC63P-13907-03	53	5031893	REC09289-20009	102-109-111	5033198	REC57632-94J00	107-135	5036040	REC25700-95D01	85
5030702	REC15410-87J10	50	5031990	REC17411-94421	81-111-113	5033221	REC65720-98520	50	5036054	REC34801-99E04	70
5030706	REC15440-99E01	51	5032030	REC32800-89J00	65	5033264	REC38860-76F01	64	5036059	REC57621-94403	113-129
5030708	REC15710-99E00	55	5032047	REC37830-89E03	63	5033299	REC08110-60020	107-130-131	5036081	REC5031482	69
5030723	REC17461-87E12	77-114	5032058	REC43211-94401	131	5033303	REC08110-60050	107-132	5036107	REC32800-38F10	65
5030724	REC17471-92J00	83				5033339	REC09283-10009	102	5036192	REC13200-91J70	55

OEM	REF	OEM	REF	OEM	REF	OEM	REF				
5036261	REC32800-94J11	65	5037432	REC17472-97J00	81	0315838	REC315838	135	0398514	REC398514	54
5036277	REC34801-93J03	70	5037490	REC11141-97J02	92	0318717	REC318717	134	0580256	REC0580256	59
5036549	REC13200-91J70	55	5037515	REC57621-91L10	129	0319085	REC319085	134	0581419	REC0581419	60
5036618	REC32800-90J00	66	5037518	PAF4-04090000	52	0320785	REC320785	135	0586767	REC0586767	64
5036629	REC11141-93J10	92	5037545	REC17400-94J00	85	0320943	REC320943	83	09141-18005	REC90171-18M04	135
5036635	REC63P-13907-03	53	5037584	REC15170-94J00	54	0320981	REC320981	83	0982949	REC982949	133
5036637	REC32800-93J03	66	5040140	PAF4-05000300	51	0321008	REC321008	83	0983298	REC983298	81
5036681	REC17472-96303	81-91-109-111-113	5040786	REC50-8M0147039	60	0321120	REC321120	76	0985612	REC985612	133
5036691	PAGB/T5783-M6X14	90-105	5583473	REC0585059	60	0321787	REC321787	133	25-26855	REC3852928	134
5036701	REC38410-93J12	70	50030396	PAGB/T5787-M6X20	107	0321932	REC321932	76	25-31305	REC553126	134
5036714	REC11400-87804	92	50317562	REC17670-87J00	75	0324334	REC324334	87	25-35029	REC25-35029	134
5036802	REC11141-95J00	92	50367173	REC17413-92J01	82	0324937	REC324937	100	25-48452	REC302035	134
5036900	REC17413-95J00	82-109	0304174	REC304174	134	0326649	REC326649	134	25-58390	REC909140	134
5036901	REC17416-95J00	82-109	0305123	REC305123	134	0326849	REC326849	134	25-62705	REC25-62705	134
5036902	REC17471-95J01	83-109	0306643	REC306643	90	0328725	REC328725	90	25-85594	REC301877	134
5036908	REC17400-95J02	85-109	0307133	REC307133	99-101	0330560	REC330560	81	25-8M0204667	REC25-62705	134
5036938	REC09282-15008	102	0307161	REC307161	131	0331901	REC331901	76	25222-96300	REC25222-96300	131
5036972	REC31100-95J01	60	0308928	REC308928	78	0338880	REC338880	56	84-819514T26	REC84-819514T26	70
5037170	REC17471-92J00	83-115	0309243	REC309243	87	0339044	REC339044	76	84-826075A2	REC84-819514T26	70
5037175	REC17417-92J00	82	0309955	REC309955	135	0339543	REC339543	134	84-826802A4	REC84-819514T26	70
5037176	REC17400-92J00	86	0310584	REC310584	134	0343512	REC343512	56	8M0204667	REC25-62705	134
5037205	REC51211-90J2	93	0313754	REC313754	134	0344470	REC344470	78	F748342	REC25-62705	134
5037356	REC59178-97J00	132	0314082	REC314082	93	0390770	REC439077	85			
5037363	PAGB/T91-1.6X12	135	0314491	REC314491	134	0394411	REC394411	76			
5037373	PAGB/T91-1.6X12	135	0315232	REC315232	57	0395270	REC395270	85			
5037431	REC17471-97J00	83	0315810	REC315810	135	0396987	REC396987	76			
			0315837	REC315837	82	0397004	REC0397004	56			

## REF --> OEM

REF	OEM	REF	OEM	REF	OEM			
<b>P</b>		REC0393988	391264	69	REC0584107	777784	69	
PAF25-00000014	5030511	115-116	REC0393988	393259	69	REC0584477	584477	58-59
PAF4-04090000	5033371	52	REC0393988	393988	69	REC0585059	585059	60
PAF4-04090000	5037518	52	REC0393988	394176	69	REC0585059	778991	60
PAF4-05000300	5040140	51	REC0393988	983019	69	REC0585059	5583473	60
PAGB/T5283-M6X25	5030391	105	REC0397004	397004	56	REC0585081	585081	65
PAGB/T5783-M6X12	5030338	115	REC0397004	0397004	56	REC0585195	583529	66
PAGB/T5783-M6X14	5036691	90-105	REC0398243		56	REC0585195	584204	66
PAGB/T5783-M6X16	5030035	105	REC0433226	433226	69	REC0585195	585195	66
PAGB/T5783-M6X16	5030038	114	REC0433325	433325	56	REC0586180	380095	64
PAGB/T5783-M8X16	5031215	111-113	REC0435230	435230	56	REC0586180	383622	64
PAGB/T5783-M8X25	5030398	115	REC0439542	439542	56	REC0586180	389398	64
PAGB/T5783-M8X30	5031216	107-113	REC0500581	396161	56	REC0586180	389493	64
PAGB/T5783-M8X55	5032766	107	REC0500581	500581	56	REC0586180	395419	64
PAGB/T5787-1986	5031822	105	REC0502880	581407	58-59	REC0586180	582708	64
PAGB/T5787-M6X20	5030037	111	REC0502890	502890	58	REC0586180	586180	64
PAGB/T5787-M6X20	50030396	107	REC0502890	582160	58	REC0586271	584641	66
PAGB/T5787-M6X30	5030394	109	REC0502890	584632	58	REC0586271	585995	66
PAGB/T6184-2000	5030051	111	REC0502890		59	REC0586271	586271	66
PAGB/T8.8-2000	5030406	115	REC0554545	554545	80-120	REC0586275	584608	60
PAGB/T818-M4X30	5030405	114	REC0580256	580256	59	REC0586275	586275	60
PAGB/T818-M6X10	5030409	107	REC0580256	0580256	59	REC0586278	277432	60
PAGB/T820-M6X20	5032945	107	REC0581419	581419	60	REC0586278	278232	60
PAGB/T848-6	530429	105	REC0581419	0581419	60	REC0586278	378674	60
PAGB/T848-6	5030068	111	REC0582452	582453	66	REC0586278	379091	60
PAGB/T848-6	5030429	109	REC0582452	583380	66	REC0586278	379818	60
PAGB/T889.1-M4	5030415	114	REC0582452		68	REC0586278	380139	60
PAGB/T91-1.6X12	5037363	135	REC0582508	582508	58-59	REC0586278	380238	60
PAGB/T91-1.6X12	5037373	135	REC0582901	582474	66	REC0586278	381864	60
PAGB/T93-6	5030068	107-113	REC0582901	582864	66	REC0586278	385401	60
PAGB/T97.1-8		111	REC0582901	582901	66	REC0586278	386591	60
<b>R</b>			REC0582901		68	REC0586278	386597	60
REC0176335	176335	74	REC0583320	583122	67	REC0586278	392133	60
REC0176340	176340	73	REC0583320	583320	67	REC0586278	585061	60
REC0176342	176342	73	REC0583320		68	REC0586278	586278	60
REC0176408	176408	74	REC0583740	583740	58-59	REC0586279	583482	61
REC0319661	319661	101	REC0583748	583748	67-68	REC0586279	585056	61
REC0319662	319662	80	REC0584028	583773	66	REC0586279	586279	61
REC0321479	321479	101	REC0584028	584027	66	REC0586281	383691	61
REC0323327	323327	57	REC0584028	584028	66	REC0586281	384777	61
REC0324323	3234323	100	REC0584028		68	REC0586281	386657	61
REC0326260	326260	101	REC0584107	387277	69	REC0586281	391735	61
REC0326264	326264	100	REC0584107	582047	69	REC0586281	585058	61
REC0329319	329319	76	REC0584107	582048	69	REC0586281	585197	61
REC0330621	330621	99	REC0584107	582155	69	REC0586281	586281	61
REC0355911	355911	56	REC0584107	584107	69	REC0586283	385529	61

REF	OEM		REF	OEM		REF	OEM	
REC0586283	386465	61	REC09116-06121	5030391	90-109-111	REC11489-93E11	5034462	100
REC0586283	389380	61	REC09116-06121	5032502	90	REC11489-93J00	5034878	100
REC0586283	389954	61	REC09141-12005	5032950	135	REC115742	115742	66-68
REC0586283	391554	61	REC09160-20027	5032966	129	REC12-191833	307552	117-118
REC0586283	585051	61	REC09160-20041	5032985	107-128	REC12-191833	311598	123
REC0586283	585057	61	REC09160-20042	5032967	107-128	REC125017	302540	80
REC0586283	585196	61	REC09160-20043	5032968	107-128	REC12761-72F00	5030660	99
REC0586283	586282	61	REC09160-20044	5032969	107-128	REC12761-93ELO	5033070	99
REC0586283	586283	61	REC09160-21009	5032970	107-129	REC13-35048	305981	127
REC0586284	584980	61	REC09160-26015	5031232	113-129	REC13119-93J00	5034959	101
REC0586284	586284	61	REC09168-10022	5030071	102-105-107-109-111-113-114-115	REC13200-91J70	5036191	55
REC0586287	438878	61	REC09168-10034	5034799	116-132	REC13200-91J70	5036192	55
REC0586287	586257	61	REC09168-12012	5030465	52	REC13200-91J70	5036549	55
REC0586697	396141	66	REC09168-12017	5031863	52	REC13250-95D01	5033086	55
REC0586697	582281	66	REC09168-12017	5032987	52	REC13421-87J00	5031390	91-94
REC0586697	582285	66	REC09202-04002	5030084	113-135	REC13650-52G00	5031392	57
REC0586697	582502	66	REC09202-05022	5031245	129	REC13650-56B00	5030687	57
REC0586697	582757	66	REC09204-02004	5032996	135	REC1399-07350	397839	52
REC0586697	582880	66	REC09209-08016	5031880	109-111-129	REC1399-07351	438562	53
REC0586697	583167	66	REC09248-10008	5030094	105-107-109-111-113-114-115-132	REC1399-07352	438556	53
REC0586697	583168	66	REC09263-20046	5031883	109-111-130	REC1399-07353	438555	53
REC0586697	583169	66	REC09263-20047	5031884	109-111-132	REC15-101		59
REC0586697	583170	66	REC09263-20L04	5033003	107-128	REC15-102		59
REC0586697	583175	66	REC09263-22020	5031255	113-132	REC15-103		59
REC0586697	583604	66	REC09263-22L03	5031256	113-130	REC15-104		59
REC0586697	586767	64	REC09263-25025	5031257	113-132	REC15-201		59
REC0586767	0586767	64	REC09263-25062	5031258	113-132	REC15-202		59
REC0586798	584783	66-68	REC09265-17002	5031885	109-111-130	REC15-203		59
REC0586957	384799	62	REC09280-08005	5031260	131	REC15-204		59
REC0586957	391511	62	REC09280-11001	5031261	131	REC15170-91J00	5033372	54
REC0586957	396235	62	REC09280-22019	5035305	90	REC15170-94J00	5037584	54
REC0586957	397023	62	REC09280-54001	5033009	52	REC15170-98110	5030181	54
REC0586957	584799	62	REC09280-57002	5033010	107-132	REC15410-87J00	5031400	51
REC0586957	586289	62	REC09280-75001	5031263	109-113-132	REC15410-87J10	5032072	50
REC0586957	586411	62	REC09282-10008	5030107	102-105	REC15410-87J30	5035974	50
REC0586957	586731	62	REC09282-12008	5030108	102	REC15410-87J00	5030702	50
REC0586957	586890	62	REC09282-12010	5033011	102	REC15410-93J00	5034984	50
REC0586957	586897	62	REC09282-15008	5036938	102	REC15410-98500	5032238	50
REC0586957	586957	62	REC09282-17005	5031264	102-113	REC15440-90J00	5033704	51
REC0763759	584109	67	REC09282-17009	5031266	102	REC15440-93J00	5034985	51
REC0763759	584981	67	REC09283-10003	5030109	102	REC15440-99E01	5030706	51
REC0763759		68	REC09283-10009	5033339	102	REC15626-90J00	5033706	54
REC0763763	584560	67	REC09283-20018	5030110	102	REC15626-99E00	5031114	54
REC0763763	763763	67	REC09283-20045	5030111	102	REC15710-65D00	5033708	55
REC0763763		68	REC09283-25076	5033481	102	REC15710-66D00	5032693	55
REC0763764	583710	67	REC09289-12003	5033014	107	REC15710-87J00	5031403	55
REC0763764	584292	67	REC09289-17006	5033015	102-107	REC15710-87J00	5035010	55
REC0763764	763764	67	REC09289-20009	5031893	102-109-111	REC15710-99E00	5030708	55
REC0763764		68	REC09289-22007	5031270	102-113	REC16510-05240	5033102,7	52
REC0763765	583415	67	REC09380-15001	5033027	84-107	REC16510-82703	778887	52
REC0763765	584287	67	REC09420-03002	5030137	77-78-105	REC16510-82703	5033919	52
REC0763765	763765	67	REC09420-03005	5033113	78	REC16510-87J00	778885	52
REC0763765		68	REC09420-04006	5031281	77-78-109-111-113	REC16510-87J00	5031411	52
REC0763767	583340	67	REC09420-05009	5033632	78	REC16510-90J00	778886	52
REC0763767	583536	67	REC09420-05009	5034842	78-115-116	REC16510-90J00	5033539	52
REC0763767	763767	67	REC09440-05027	5033034	107-129	REC16510-93J00	778888	52
REC0763767		68	REC09440-32008	5033037	107-129	REC16510-93J00	5035703	52
REC0763769	583410	67	REC09440-40002	5031286	113-129	REC16910-GB2-005	5030183	51
REC0763769	763769	67	REC10-79953Q04	307551	117-118-119-120-122-123-127	REC173029	173029	88
REC0763779	584643	67	REC11141-87J02	5031293	91-92	REC173029AL	173029	88
REC0763779	763779	67	REC11141-87J02	5034353	92	REC17400-87E04	5031731	86-114
REC0763779		68	REC11141-90J01	5033639	92	REC17400-90J20	5033541	86-115
REC0767407	433935	77	REC11141-91JL0	5033342	92	REC17400-92J00	5037176	86
REC0778292	387094	62	REC11141-92J01	5034644	92	REC17400-93951	5033106	85-107
REC0778292	395207	62	REC11141-93E20	5033046	92	REC17400-93J01	5035036	86
REC0778292	585062	62	REC11141-93J10	5036629	92	REC17400-94J00	5037545	85
REC0778292	586288	62	REC11141-95J00	5036802	92	REC17400-95J02	5036908	85-109
REC0778292	777693	62	REC11141-97J02	5037490	92	REC17400-96403	5031744	86-111-113
REC0778292	778992	62	REC11142-93J10	5035971	92	REC17400-96J03	5035036	116
REC0778994	393570	62	REC11189-87J00	5031297	91-92	REC17400-98652	5030352	85
REC0778994	585060	62	REC11265-87E10	5030623	90-91	REC17400-98661	5034323	85-105
REC0778994	586285	62	REC11400-87804	5031302	92	REC17411-93901	5033107	81-107
REC0778994	778994	62	REC11400-87804	5034354	92	REC17411-94421	5031990	81-111-113
REC08110-60020	5033299	107-130-131	REC11400-87804	5036714	92	REC17413-92J01	50367173	82
REC08110-60050	5033303	107-132	REC11413-87J00	5031304	91-93	REC17413-95J00	5036900	82-109
REC08113-60060	5032295	109-111-132	REC11413-87J00	5032428	93	REC17413-96J01	5035038	116
REC09116-06094	5030034	90-107-109-113-116	REC11433-87J00	5031306	91-93	REC17413-99E11	5035039	114
REC09116-06094	5030035	90	REC11489-87J00	5031307	91-100	REC17416-93J00	5036901	82-109
REC09116-06094	5030036	90	REC11489-90J00	5033649	100	REC17416-96J00	5035039	116
						REC17417-92J00	5037175	82

REF	OEM	
REC17450-93921	5033109	107
REC17452-93910	5033110	84-107
REC17453-93901	5033111	107-131
REC17453-93901	5035609	131
REC17461-87E12	5030723	77-114
REC17461-90J01	5033542	77-115-116
REC17461-93903	5033112	77-107
REC17461-96312	5031417	77-109-111-113
REC17461-98503	5030188	77-105
REC17462-93990	5033113	77-78-107
REC17471-92J00	5030724	83
REC17471-92J00	5034651	83-114
REC17471-92J00	5037170	83-115
REC17471-92J02	5035041	83-116
REC17471-93902	5033114	83-107
REC17471-94401	5031418	83-111-113
REC17471-95J01	5036902	83-109
REC17471-97J00	5037431	83
REC17471-98601	5030189	83
REC17471-98601	5031196	83
REC17472-87E10	5030725	81-114-115
REC17472-91J00	5033381	84
REC17472-93911	5035603	84-107
REC17472-93J00	5035042	84-116
REC17472-96303	5036681	91
REC17472-96303	5031419	81
REC17472-96303	5036681	81-109-111-113
REC17472-97J00	5037432	81
REC17472-98611	5030190	84
REC17616-87J00	5031426	91-93
REC176288	176288	63
REC176333	176333	74
REC176334	176334	74
REC176335	176335	74
REC176339	176339	73
REC176340	176340	73
REC176341	176341	73
REC176342	176342	73
REC17670-87J00	50317562	75
REC17670-90J10	5033722	75
REC17670-91J01	5033385	75
REC17670-93962	5030742	75
REC17670-93962	5031175	75
REC17670-94402	5031758	75
REC17670-94J01	5036226	75
REC17685-87D10	5031430	91-93
REC17913-93J00	5035054	77
REC17914-93J00	5035055	77
REC18-32665	302804	135
REC18137-52D00	5035412	57
REC18590-72F21	5033780	57
REC203130	203130	98-99
REC23311-95DLO	5031449	131
REC25-25439	3852565	80
REC25-30224	310327	121
REC25-30613	310585	80-127
REC25-30613	310967	80
REC25-33145	302337	80
REC25-35027	303360	80
REC25-35029	35029	134
REC25-35029	802231	134
REC25-35029	882613	134
REC25-35029	25-35029	134
REC25-48171	202893	80
REC25-62702	303191	80
REC25-62705	62705	134
REC25-62705	25-62705	134
REC25-62705	25-	134
REC25-62705	8M0204667	134
REC25-62705	8M0204667	134
REC25-62705	F748342	134
REC25222-93901	5030215	131
REC25222-96300	25222-96300	131
REC25700-88L00	5031456	113-133
REC25700-95D01	5032167	85
REC25700-95D01	5036040	85
REC26-419533	313992	78
REC26-43035		79
REC26-69188	321453	78-79-120-127
REC26-76868	320862	78-79-125-127
REC27-62386001	310058	76

REF	OEM	
REC300-01633	330525	63
REC300-01744	203698	63
REC300-03587	585001	65
REC300-03588	584890	65
REC300611	300611	77-78-118
REC301877	85594	134
REC301877	25-85594	134
REC301967	301967	134
REC302035	25-48452	134
REC302325	302325	86
REC302325	302873	86
REC302325	319126	86
REC302325	324960	86
REC302497	302497	117-118-119-120
REC302537	302537	134
REC302588	302588	80-122
REC303339	303339	84
REC303339	802208	84
REC303347	303347	80-120
REC303615	303615	53
REC304174	304174	134
REC304174	508507	134
REC304174	0304174	134
REC305123	305123	134
REC305123	322119	134
REC305123	508986	134
REC305123	0305123	134
REC305242	305242	80-117
REC305762	305762	83
REC306643	306643	90
REC306643	0306643	90
REC307133	307133	99-101
REC307133	0307133	99-101
REC307161	307161	131
REC307161	0307161	131
REC308627	308627	118
REC308876	308876	80
REC308928	308928	78
REC308928	0308928	78
REC309004	309004	119
REC309243	309243	87
REC309243	0309243	87
REC309955	309955	135
REC309955	0309955	135
REC31-17514A2	437088	95
REC31-32575T1	385175	122-130
REC310414	310414	80
REC310584	310584	134
REC310584	0310584	134
REC31100-87J00	5030780	61
REC31100-90J01	5033799	61
REC31100-95J01	5036972	60
REC31100-96J02	5035078	62
REC311598	311598	131
REC313175	313175	134
REC313754	313754	134
REC313754	0313754	134
REC313782	313782	97-99
REC314082	314082	93
REC314082	0314082	93
REC314491	314491	134
REC314491	0314491	134
REC314728	314728	134
REC314728	354731	134
REC315232	315232	57
REC315232	0315232	57
REC315788	315788	122
REC315810	315810	135
REC315810	0315810	135
REC315837	315837	82
REC315837	0315837	82
REC315838	315838	135
REC315838	0315838	135
REC318358	318358	98
REC318358		99
REC318372	318372	80-121-122-123-124-125-126-127
REC318717	318717	134
REC318717	0318717	134
REC318924	318924	101

REF	OEM	
REC318925	318925	100
REC318932	318932	101
REC318972	318972	78-79-118
REC319085	319085	134
REC319085	0319085	134
REC319332	319332	101
REC320775	320775	82
REC320776	320776	82
REC320785	320785	135
REC320785	0320785	135
REC320936	320936	100-124-125-126
REC320943	320943	83
REC320943	0320943	83
REC320961	320961	100-124-125
REC320981	320981	83
REC320981	0320981	83
REC321008	321008	83
REC321008	0321008	83
REC321120	321120	76
REC321120	5006373	76
REC321120	0321120	76
REC321459	321459	78-79-119
REC321466	321466	78-79
REC321467	321467	78-79-94-121-122
REC321480	321480	78-79-118
REC321481	321481	118
REC321481	334950	78
REC321481		79
REC321497	321497	102
REC321787	321787	133
REC321787	0321787	133
REC321794	3214794	102
REC321886	321886	76
REC321895	321895	78-79-84
REC321928	321928	78-79-120
REC321932	321932	76
REC321932	0321932	76
REC322494	322494	117
REC323338	323338	102
REC324334	324334	87
REC324334	0324334	87
REC324449	324449	119
REC324639	324639	78-79-117
REC324641	324641	82-87-117
REC324717	324717	99
REC324852	324852	121-126
REC324937	324937	100
REC324937	5000309	100
REC324937	0324937	100
REC324981	324981	121-123
REC325040	325040	117
REC325092	325092	101
REC325260	325260	120
REC325537	325537	101
REC325721	325721	99
REC326649	326649	134
REC326649	329380	134
REC326649	508493	134
REC326649	509009	134
REC326649	909047	134
REC326649	910582	134
REC326649	0326649	134
REC326849	326849	134
REC326849	509009	134
REC326849	0326849	134
REC326926	326926	101
REC327031	327031	78-79
REC327606		89
REC327606AL		89
REC327674	327674	101
REC327707	327707	101
REC32800-38F10	5036107	65
REC32800-87J10	5032615	65
REC32800-89J00	5032030	65
REC32800-89J11	5034680	65
REC32800-90J00	5033820	66
REC32800-90J00	5036618	66
REC32800-92E20	5030795	65
REC32800-93J03	5036637	66
REC32800-94620	5034255	64

REF	OEM	REF	OEM	REF	OEM			
REC32800-94J11	5036261	65	REC343512	343512	56	REC394411	394411	76
REC32800-95D01	5030356	65-68	REC343512	0343512	56	REC394411	0394411	76
REC328603	328603	94	REC343863	343863	100	REC394462	394462	94
REC328725	328725	90	REC344470	330619	78	REC394711	394711	85-87
REC328725	0328725	90	REC344470	344470	78	REC394930	394930	97
REC328751	328751	82	REC344470	0344470	78	REC395270	395270	85
REC328753	328753	120	REC34801-93J03	5035099	70	REC395270	0395270	85
REC329103	329103	98-99	REC34801-93J03	5036277	70	REC395289	395289	77-119-120
REC329390	329390	119	REC34801-99E04	5031116	70	REC395627	395627	95-96
REC329419	329419	97-99	REC34801-99E04	5031474	70	REC395861	395861	94
REC329828	329828	99	REC34801-99E04	5036054	70	REC396350	396350	133
REC329830	329830	76	REC35-49088A2	312456	50	REC396351	396351	120-133
REC329836	329836	98-99	REC351018	351018	99	REC396377	396377	97
REC329920	329920	101	REC355964	355964	88	REC396514	375919	55
REC329922	329922	78-79	REC355964AL	355964	88	REC396514	386149	55
REC329923	329923	78-79-94	REC357507	357507	88	REC396514	396514	55
REC330137	330137	78-79-123-124	REC357507AL	357507	88	REC396514	766419	55
REC330560	330560	81	REC377139	377139	95-96	REC396521	378895	55
REC330560	0330560	81	REC37820-92E03	5031481	63	REC396521	396521	55
REC330818		97	REC37830-89E03	5030225	63	REC396521	678882	55
	331103	78	REC37830-89E03	5032047	63	REC396522	379312	55
REC331107	331107	77-78-126	REC38100-87J00	5031482	69	REC396522	396522	55
REC331188	321175	127	REC38100-96J00	5033838	69	REC396701	392061	56
REC331188	331188	121-124-125-126	REC38100-96J00	5034526	69	REC396701	396701	56
REC331353	331353	124-125-126-127	REC38100-96J00	5034627	69	REC396701	398729	56
REC331880	331880	123-125-126	REC38100-96J00	5035113	69	REC396725	396725	77-123
REC331901	331901	78	REC38100-96J00	5035513	69	REC396987	396987	76
REC331901	0331901	78	REC384087	384087	81	REC396987	0396987	76
REC331980	324430	86	REC38410-93J12	5034606	70	REC398042	398042	125-126-135
REC331980	331980	86	REC38410-93J12	5036701	70	REC398051	398051	94
REC33220-76G02	5031468	58	REC385072	385072	77	REC398514	398514	54
REC33220-76G02	5032786	58	REC3852045	303067	80	REC398514	0398514	54
REC332261	332261	78-79-120	REC3852045	329381	80	REC398529	398529	95-96
REC332584	332584	121-122-126	REC3852045	332584	123	REC398873	398873	88
REC333008	333008	102	REC385210	313416	76	REC398873AL	398873	88
REC333758	333758	121	REC3852548	3852548	78	REC40135	398319	50
REC33410-94400-000	5032732	58	REC3852928	26855	134	REC40135	398327	50
REC334897	334897	77-78-121-123	REC3852928	25-26855	134	REC40145	354016	50
REC334950	334950	125-126	REC3853655	916058	78	REC40155	398327	50
REC335359	327795	97	REC3853839	385389	64	REC40155	509128	50
REC335359	335359	97	REC3853839	586730	64	REC40165	360941	50
REC335359	335359	99	REC3853839	586842	64	REC423-6349	176349	74
REC336308	336308	100	REC3853839	778209	64	REC431870	431870	97
REC336493	336493	117	REC3853839	980801	64	REC43211-87JLO	5032058	131
REC336530	336530	121-123	REC3853839	981703	64	REC43211-94401	5032058	131
REC336947	336947	76	REC3853839	982189	64	REC432230	432230	63
REC338222	338222	98	REC3853839	985064	64	REC432397	432397	88
REC338484	338484	124-125-126-127	REC3855081	311598	120-121-122-124-125-126	REC432397AL	432397	88
REC338485	321188	83	REC3857533	581295	64	REC432941	432941	77-121
REC338485	338485	83	REC3857533	582472	64	REC432955	432955	86-87
REC338485	435027	83	REC3857533	582473	64	REC432962	432962	54
REC338486	338486	82-87-125-126-127	REC3857533	584416	64	REC433190	433190	50
REC338518	313893	80	REC3857533	586147	64	REC433190	765553	50
REC338518	338518	80-120	REC3857533	586224	64	REC433458	433458	88
REC338632	338632	76	REC3857533	777702	64	REC433458AL	433458	88
REC338635	338635	88	REC386084	386084	77-118	REC433550	433550	133
REC338635AL	338635	88	REC386918	386279	97	REC434424	434424	77
REC338742	338742	88	REC387247	387247	125-127-130	REC434839	434839	52
REC338742AL	338742	88	REC387817	387817	125-126-127-130	REC434844	434844	95-96
REC338876	338876	53	REC388344	388344	95-96	REC435491	435491	75
REC338879	338879	53	REC38860-76F01	5033264	64	REC435546	5006655	97
REC338880	338880	56	REC389576	389576	77	REC435957	321692	84
REC338880	0338880	56	REC389576	436137	77-117	REC436254	436254	97
REC338884	338884	56	REC389577	389577	81-87-117	REC436745		89
REC338884	802310	56	REC389999	389999	88	REC436745AL	436745	89-122-124-125-126
REC338884	879010	56	REC389999AL	389999	88	REC437090	437090	75
REC338886	338886	56	REC390286	390286	77	REC43711-97E11	5030852	131
REC338886	802302	56	REC390509	390509	97	REC43713	43713	133
REC339044	339044	76	REC391170	391170	97	REC438559	438559	53
REC339044	0339044	76	REC392123	392123	88	REC438559	765591	53
REC339543	303059	134	REC392123AL	392123	88	REC438616	438616	54
REC339543	339543	134	REC392462	392462	88	REC438996	435442	56
REC339543	508691	134	REC392462AL	392462	88	REC438996	438996	56
REC339543	0339543	134	REC393088	393088	54	REC439071	382049	56
REC341732	341732	121-122-123	REC393103	393103	54	REC439071	383052	56
REC342786	321466	122	REC393630	393630	85-87-120	REC439071	383067	56
REC342786	332205	78	REC393632	393632	81-87-120	REC439071	398532	56
REC342786	342786	78-79-121-122-123	REC39390	398047	98	REC439071	439071	56
			REC39390	438904	98	REC439072	391305	56
			REC39390		99	REC439072	398452	56

REF	OEM		REF	OEM		REF	OEM	
REC439072	398453	56	REC55125-90J01AL	5032929	114-115	REC764666	764666	73
REC439072	439072	56	REC55125-90J01AL	5035150	116	REC765431	382547	77-123
REC439074	4359073	56	REC55125-91L01		89	REC775518	375638	77
REC439076	392550	56	REC55125-91L01AL	5032091	109	REC777129	331107	125
REC439076	398526	56	REC55125-91L01AL	5032191	111	REC777129	389589	77
REC439076	434888	56	REC55125-91L01AL		89	REC777212	385528	127
REC439076	435443	56	REC55125-95500		89	REC777212	389642	77
REC439076	439076	56	REC55125-95500AL	5031536	89-113	REC777213	377230	77-122
REC439077	390770	85	REC55128-93J10	5035151	116-132	REC777214	396809	77-122
REC439077	439077	85	REC553126	31305	134	REC802113	394546	98-99
REC439077	0390770	85	REC553126	25-31305	134	REC802133	392567	98
REC439078	43577	56	REC55320-94900		89	REC802133	392615	98
REC439078	435676	56	REC55320-94900AL		89	REC802133	433941	98
REC439078	435678	56	REC55320-95311		89	REC802133		99
REC439078	435752	56	REC55320-95311AL	5035786	90-116	REC802243	313065	100
REC439078	439078	56	REC55320-98400		89	REC802288	325273	98-99
REC4428	439347	53	REC55320-98400AL	5033167	89-107	REC802307	332010	98-99
REC4428	5000800	53	REC55321-87J01		89	REC84-819514T26	84-819514T26	70
REC4428	5004428	53	REC55321-87J01AL	5031705	89-90-105	REC84-819514T26	84-826075A2	70
REC48630-92J00	5033935	70	REC55321-90J01		89	REC84-819514T26	84-826802A4	70
REC48630-94900	5030870	70	REC55321-90J01AL	5032930	89-114-115	REC878763	396041	95-96
REC50-8M0147039	5040786	60	REC56120-93900	5032743	107-132	REC878904	436195	75-77
REC5001344	584767	67	REC56120-94321-OEP	5032801	113	REC89-825096T01	5030783	64
REC5001344	584768	67	REC56120-96332-OEP	5034711	109-111-132	REC8M0058226	509219	64
REC5001344	584908	67	REC56130-94413-OEP	5032802	82-113	REC90171-18M04	5030422	113-114-115-116
REC5001344	585074	67	REC57100-93902	5033188	107	REC90171-18M04	09141-18005	135
REC5001344		68	REC57311-93910	5033190	107-128	REC90179-08M06	5031827	109-111
REC5001593	435821	77-124	REC57311-96311	5032098	128	REC908194	908194	80
REC5001593	5001593	77-125-126	REC57311-96320	5032098	109-111	REC909048	802149	134
REC5001594	5001594	86-87	REC57311-98600	5030276	105-128	REC909139	802149	134
REC5001595	5001595	86-87	REC57510-89J00	5032099	128	REC909140	58390	134
REC5004428	439347	53	REC57510-89J00	5032689	109	REC909140	802151	134
REC5004428	5000800	53	REC57510-89J00	5032698	111-128	REC909140	25-58390	134
REC5004428	5004428	53	REC57510-89J00	5036016	128	REC910238	802383	134
REC5005254	435532	70	REC57510-91J00	5030277	128	REC911685	911685	78
REC5005254	437801	70	REC57510-91J00	5031203	128	REC912157	912157	82
REC5005254	438786	70	REC57510-91J00	5034203	105-128	REC91490-30025	5030087	105-109-111-113-114-115-116-135
REC5005254	439937	70	REC57510-93910	5033191	107-128	REC925093	320303	122
REC5005254	5005254	70	REC57521-89J00	5032100	109-111-128	REC925093	5031890	111
REC5005376	434495	69	REC57521-91J00	5030278	105-128	REC93-06511	312932	62
REC5005376	434496	69	REC57521-93910	5033192	107-128	REC93-06522	323653	62
REC5005376	438529	69	REC57521-96312	5032100	128	REC93-06522	338534	62
REC5005376	438531	69	REC57610-93901	5033193	107-130	REC93-06522		62
REC5005376	5005374	69	REC57610-94402	5031546	113	REC93-08665	330527	62
REC5005801	175974	63	REC57610-96311	5032101	109-111	REC93-08668	395460	62
REC5005801	5005801	63	REC57621-91L10	5032102	129	REC93606-12019	5030508	115-116
REC5005831	5005822	69	REC57621-91L10	5037515	129	REC95380-06700	5030051	105-107-109-113
REC5005831	5005831	69	REC57621-94403	5031547	129	REC967344	313446	80-123-124
REC5005831	5005875	69	REC57621-94403	5036059	113-129	REC982949	982949	133
REC5005831	5006479	69	REC57631-93901	5033196	107-129	REC982949	0982949	133
REC5006063	5006063	53	REC57631-95303	5031549	113-129	REC983298	983298	81
REC5006180	5006180	71-73	REC57631-96301	5032103	111-129	REC983298	0983298	81
REC5006181	5006181	71	REC57632-94J00	5033197	107-135	REC985612	985612	133
REC5006182	5006182	72-73	REC57632-97L00	5030282	105-129	REC985612	0985612	133
REC5006184	5006184	72-73	REC57633-93901	5033198	107-135	REC985612		133
REC5006186	5006186	72-73	REC57634-88L00	5031251	113-129	RECKITOMC50-75AL		90
REC5006319	5005817	70	REC581778	581778	65	RECKITOMC50-75M		90
REC5006319	5005838	70	REC584348	584348	59	RECKITOMC50-75ZN		90
REC5006319	5006319	70	REC584561	582366	58	RECKITOMCV4-V6AL		90
REC5006358	5006358	73	REC584561	583737	58	RECKITOMCV4-V6M		90
REC5006561	5006561	71-73	REC584561	584561	58	RECKITOMCV4-V6ZN		90
REC5007335	5005266	51	REC584561		58-59			
REC5007335	5007326	51	REC584580	584580	64			
REC5007485	5007485	73	REC586774	586774	64			
REC5007497	5007494	63	REC586774	5009214	64			
REC5007497	5007497	74	REC587012	587012	59			
REC5007582	5007582	88	REC59178-97J00	5037356	132			
REC5009220	5009220	88	REC63P-13907-03	5030700	53			
REC5009220AL	5009220	88	REC63P-13907-03	5032617	53			
REC5010190		89	REC63P-13907-03	5033702	53			
REC5010190AL		89	REC63P-13907-03	5036635	53			
REC5030267	5030267	88	REC65720-98520	5033221	50			
REC5030267A	5030267	88	REC65720-986L0	5032150	50			
REC5031482	5031482	69	REC65L-24563-00	778162	51			
REC5031482	5032670	69	REC65L-24563-00	5035695	51			
REC5031482	5036081	69	REC67F-12411-01	5033721	75			
REC51211-87J00	5031523	91-93	REC69J-24501-10	5034995	51			
REC51211-90J10	5034757	93	REC6F5-12411-03	434841	75			
REC51211-90J2	5037205	93	REC6F5-12411-03	5005440	75			
REC51211-93J00	5035138	93	REC6F5-12411-03		77			
REC55122-94400	5031535	84	REC763735	387361	77			

## POLÍTICA DE GARANTÍA RECMAR

Todos los productos comercializados por **RECMAR** deben ser instalados y utilizados por personal competente bajo su exclusiva responsabilidad. **RECMAR** no se responsabiliza de las consecuencias producidas por una instalación defectuosa o inapropiada de ningún artículo que no incluya soluciones de instalación.

El instalador será el responsable de verificar la correcta aplicación de las recomendaciones del fabricante en cuanto a compatibilidades de uso.

Los artículos comercializados por **RECMAR** están amparados por la garantía legal.

**RECMAR** distribuye los artículos presentes en sus catálogos únicamente a profesionales, nunca a particulares o cliente final, el importe de la instalación jamás estará incluido en el precio por lo que no será responsable de ésta.

Los artículos comercializados por **RECMAR** disponen de una garantía limitada por defectos de fabricación, los periodos pueden variar entre los 3 años y los 3 meses, descartando los artículos considerados como consumibles: productos eléctricos, baterías y otros que carecen de periodo alguno, si necesita conocer el plazo exacto del producto contacte con el departamento comercial.

El material que enviamos diariamente desde **RECMAR** a nuestros clientes es examinado antes de empaquetarse para su perfecta integridad y evitar daños en el transporte. Recuerde que es muy importante inspeccionar las cargas en presencia del transportista. Cuando se observen daños en la caja, deberá incluirse en el albarán de entrega del transportista una mención del tipo (CONFORME MERCANCÍA, SALVO INSPECCIÓN), y deberá ser firmada por usted y el transportista. En caso de recibir material defectuoso por estas causas debe hacerlo constar tanto al transportista como a **RECMAR** para poder reclamar a la empresa de transporte correspondiente.

## SOLICITUD DE GARANTÍA

La garantía siempre estará sujeta a la valoración final del departamento técnico de **RECMAR**. Esta valoración se llevará a cabo en nuestras instalaciones o en caso necesario por el fabricante del artículo, en ambas opciones el artículo tiene que estar físicamente en nuestras instalaciones centrales de Viladecans. El tiempo para la resolución será un máximo de 30 días naturales desde su recepción.

Para enviar el artículo defectuoso, debe ir a la página web [www.recambiosmarinos.es](http://www.recambiosmarinos.es), o [www.usarecmar.com](http://www.usarecmar.com) ir a su cuenta y seleccionar TRAMITAR GARANTÍA dentro del área privada, desde aquí podrá descargar el archivo para la solicitud de garantías de motores y piezas, y seguir las instrucciones.

**RECMAR** no asumirá ningún préstamo de reemplazo durante el proceso de garantía.

## EXCLUSIONES DE GARANTÍA

**RECMAR** no podrá ser acusado como responsable del defecto ante:

- Desgaste normal del producto.
- Defectos de instalación o uso inadecuado.
- Instalación de un artículo no destinado a ese modelo.
- Daños por causa externa (accidente, rayo, fluctuación de corriente...)
- Defectos y consecuencias relacionadas con el transporte.
- Alteraciones en instalaciones o barcos destinados a la competición.

En caso de rechazo de la garantía, el cliente tiene la posibilidad de recuperar su artículo defectuoso poniéndose en contacto con nosotros vía e-mail solicitando la devolución del mismo dentro de los 7 días naturales siguientes a la fecha en que se le informó del rechazo de garantía.

**RECMAR** no forma parte de las garantías comerciales anunciadas en ocasiones por los fabricantes.

## RECMAR WARRANTY POLICY

All products sold by **RECMAR** must be installed and used by competent personnel under their exclusive responsibility. **RECMAR** shall not be responsible for the consequences of the faulty or improper installation of any item that does not include installation solutions.

The fitter will be responsible for checking that the manufacturer recommendations have been followed correctly in terms of compatible uses.

Articles sold by **RECMAR** are covered by legal warranty.

**RECMAR** distribute the products only to professionals and never to private final clients. The cost of installing the part would never be included in the price for which reason, **RECMAR** would never be responsible for its installation.

Articles sold by **RECMAR** are covered by warranty for manufacturing defects for a limited period of time that may vary between 3 years and 3 months, except for the articles considered consumable, electrical products, batteries and others that are not covered at all. For information on the exact warranty period of an article, please contact the Sales Department.

The goods that **RECMAR** sends every day to its customers are examined before being packed to ensure their perfect integrity and avoid damage during shipping. Remember that it is essential to check the goods in the presence of the dispatcher. If the package is damaged, the dispatcher's delivery note must mention what type (CONFORMING GOODS, UNLESS INSPECTED), and must be signed by you and by the dispatcher. If you receive damaged goods for these reasons you must notify both the dispatcher and **RECMAR** to be able to make the claim to the relevant delivery company.

## WARRANTY CLAIMS

Warranties are always subject to **RECMAR** Technical Department's assessment. The assessment will be carried out on **RECMAR**'s premises or, if necessary, by the article's manufacturer. In both cases, the article must be physically on **RECMAR**'s premises in Viladecans. Assessment time will not exceed 30 calendar days from receiving the article.

To return the faulty item, visit [www.recambiosmarinos.es](http://www.recambiosmarinos.es), or [www.usarecmar.com](http://www.usarecmar.com), go to your account and select PROCESS WARRANTY in the private section. From there you will be able to download the file to claim the warranty of engines and parts and follow the instructions.

**RECMAR** will not charge for the loan of the replacement during the warranty process.

## WARRANTY EXCLUSIONS

**RECMAR** shall not be responsible for product faults in the following cases:

- Normal wear and tear of a product.
- Installation faults or improper use.
- Installation of an article not designed for the model in question.
- Damage due to external causes (accidents, lightning, power surges...)
- Defects and consequences of transport.
- Alterations to installations or to boats intended for competitions.

If the warranty is refused, the customer may retrieve the faulty article by contacting **RECMAR** via email and requesting that the article is returned to them within 7 calendar days from the day the warranty was refused.

**RECMAR** does not apply the warranties offered from time to time by manufacturers.



**RECMAR**  
USA

1917 NW 79 Ave  
Miami, FL 33126

Ph. 786-962-5020

[info@usarecmar.com](mailto:info@usarecmar.com)

[www.usarecmar.com](http://www.usarecmar.com)

**RECMAR**<sup>®</sup>

Jocelyn Bell, 26  
08840 Viladecans  
Barcelona

phone: (+34) 93 662 66 55

[info@recambiosmarinos.es](mailto:info@recambiosmarinos.es)  
[www.recambiosmarinos.es](http://www.recambiosmarinos.es)

[www.recmar.es](http://www.recmar.es)