















# RECMAR®





HIGH QUALITY MARINE PARTS











# FOR TOHATSU



## ICONOS ICONS

|                                                                                     |                     |                  |
|-------------------------------------------------------------------------------------|---------------------|------------------|
|    | Medida              | Measures         |
|    | Peso                | Weight           |
|    | Material            | Material         |
|    | Flujo<br>Velocidad  | Flow<br>Speed    |
|    | Presión             | Pressure         |
|    | Temperatura         | Temperature      |
|    | Electricidad        | Power            |
|    | Unidades x bolsa    | Units x bag      |
|    | Unidades x skinpack | Units x skinpack |
|    | Tornillo            | Screw            |
|   | Tubo<br>Manguera    | Tube             |
|  | Rosca               | Thread           |
|  | Rosca Macho         | Male Thread      |
|  | Entrada             | IN               |
|  | Salida              | OUT              |

|                                                                                     |                      |                |
|-------------------------------------------------------------------------------------|----------------------|----------------|
|    | Filtro               | Filter         |
|    | Elemento filtro      | Filter Element |
|    | Junta                | Gasket         |
|    | Llave                | Key            |
|    | Posiciones llave     | Key positions  |
|    | Mando                | Control        |
|    | Pins                 | Pins           |
|    | Cables<br>Terminales | Terminals      |
|    | Cable                | Cable          |
|    | Piston               | Piston         |
|   | Aros de piston       | Piston ring    |
|  | Cojinete             | Bearing        |
|  | Bulón                | Pin            |
|  | Biela                | Connecting rod |
|  | Clip                 | Clip           |

|                                                                                      |                     |                   |
|--------------------------------------------------------------------------------------|---------------------|-------------------|
|   | Impulsor            | Impeller          |
|   | Dientes             | Tooth             |
|   | Aguja carburador    | Carburetor needle |
|   | Flotador carburador | Carburetor float  |
|   | Abrazadera          | Clamp             |
|   | Volante motor       | Flywheel          |
|   | Estrias             | Spline            |
|   | Polea               | Pulley            |
|   | Solenide<br>Relé    | Solenoid<br>Relay |
|  | Motor               | Motor             |

## IMPORTANTE

LOS PRODUCTOS QUE APARECEN EN NUESTROS CATALOGOS SON VÁLIDOS Y COMPATIBLES CON LOS MOTORES Y TRANSMISIONES DE LAS MARCAS ORIGINALES QUE APARECEN EN CADA SECCIÓN. ESTA INFORMACIÓN APARECE CON LA REFERENCIA EN EL MOMENTO DE CONFIRMAR EL PEDIDO POR NUESTRA WEB.

LA IMÁGENES AQUÍ CONTENIDAS PUEDEN NO CORRESPONDER CON TOTAL PRECISIÓN AL PRODUCTO SUMINISTRADO. RECAMBIOS MARINOS, S.L.U. SE RESERVA EL DERECHO DE ANULAR O CAMBIAR PRODUCTOS SIN PREVIO AVISO.

## IMPORTANT

THE PRODUCTS THAT APPEAR IN OUR CATALOGS ARE VALID AND COMPATIBLE WITH THE MOTORS AND TRANSMISSIONS OF THE ORIGINAL BRANDS THAT APPEAR IN EACH SECTION. THIS INFORMATION APPEARS WITH THE REFERENCE AT THE TIME OF CONFIRMING THE ORDER BY OUR WEB.

IMAGES CONTAINED HERE MAY NOT CORRESPOND WITH TOTAL ACCURACY TO THE PRODUCT SUPPLIED. RECAMBIOS MARINOS, S.L.U. RESERVES THE RIGHT TO CANCEL OR CHANGE PRODUCTS WITHOUT PRIOR NOTICE.

## EN

|                                 |     |                          |     |                           |     |
|---------------------------------|-----|--------------------------|-----|---------------------------|-----|
| DRIVES MAINTENANCE GUIDE & KITS | 643 | WIRING HARNESS           | 649 | MFS8 • MFS9.9             | 657 |
| FUEL & FILTRATION SYSTEM        | 643 | STEERING SYSTEM          | 650 | PISTONS                   | 661 |
| CARBURATOR                      | 645 | COMPONENTS               | 651 | PISTON KITS               | 661 |
| CARBURETOR KITS                 | 645 | ENGINE CONTROLS          | 650 | OIL SEALS                 | 662 |
| FLOATS                          | 646 | COOLING SYSTEM           | 652 | EXHAUST SYSTEM            | 663 |
| FULL CARBURATOR                 | 645 | ANODES                   | 652 | EXHAUST SYSTEM GASKETS    | 663 |
| FUEL FILTERS AND ELEMENTS       | 644 | IMPELLERS                | 652 | UNIT DRIVES & COMPONENTS  | 663 |
| IN-LINE FUEL FILTER             | 644 | THERMOSTAT               | 652 | DRIVE COMPONENTS GUIDE    | 663 |
| FUEL PUMP                       | 643 | WATER PUMP               | 653 | GEAR CASE PARTS 4 STROKES | 664 |
| DIAPHRAGMS & GASKETS            | 644 | GASKET                   | 653 | MFS8 • MFS9.8             | 664 |
| OIL FILTER                      | 645 | GASKET BASE              | 653 | OEM --> REF               | 668 |
| ELECTRIC SYSTEM                 | 646 | INSERT CUP               | 653 | REF --> OEM               | 670 |
| CDI & POWER PACK                | 649 | SERVICE KIT              | 653 |                           |     |
| COILS                           | 647 | ENGINE PARTS             | 654 |                           |     |
| CHARGER COIL                    | 647 | CRANKSHAFT               | 662 |                           |     |
| IGNITION COIL                   | 647 | CRANKSHAFT BEARINGS      | 662 |                           |     |
| PULSER COIL                     | 647 | ENGINE GASKETS 4 STROKES | 660 |                           |     |
| STARTER COIL                    | 647 | GASKET, CYLINDER COVER   | 660 |                           |     |
| SENSORS                         | 646 | GASKET, CYLINDER HEAD    | 660 |                           |     |
| SENSOR, OIL PRESURE             | 646 | ENGINE PARTS 2 STROKES   | 654 |                           |     |
| SENSOR, OXYGEN                  | 646 | M4C • M5B • M5BS         | 654 |                           |     |
| SENSOR, CAMSHAFT                | 646 | M6B • M8B • M9.8B        | 654 |                           |     |
| STARTERS                        | 648 | M9.9D • M15D2 • M18E2    | 655 |                           |     |
| TRIM, TILT & POWER TRIM         | 649 | M25C3 • M30A4            | 655 |                           |     |
| COMPLETE TRIM ASSEMBLY          | 649 | M40D2 • M50D2            | 656 |                           |     |
|                                 |     | ENGINE PARTS 4 STROKES   | 657 |                           |     |

## ES

|                                      |     |                                  |     |                                    |     |
|--------------------------------------|-----|----------------------------------|-----|------------------------------------|-----|
| GUÍA MANTENIMIENTO                   | 643 | SISTEMA DE GOBIERNO              | 650 | PISTONES                           | 661 |
| SISTEMA DE ALIMENTACIÓN Y FILTRACIÓN | 643 | COMPONENTES                      | 651 | KIT DE PISTONES                    | 661 |
| BOMBA DE COMBUSTIBLE                 | 643 | MANDOS DE CONTROL                | 650 | RETENES DE ACEITE                  | 662 |
| KITS MEMBRANAS Y JUNTAS              | 644 | SISTEMA DE REFRIGERACIÓN         | 652 | SISTEMA DE ESCAPE                  | 663 |
| CARBURADOR                           | 645 | ÁNODOS                           | 652 | SISTEMA DE ESCAPE JUNTAS DE ESCAPE | 663 |
| BOYAS                                | 646 | BOMBA DE AGUA                    | 653 | UNIDADES DE TRANSMISIÓN            | 663 |
| CARBURADOR COMPLETO                  | 645 | CASQUILLO INOX                   | 653 | DESPIECE COLAS 4 TIEMPOS           | 664 |
| KITS CARBURADORES                    | 645 | JUNTAS BOMBA                     | 653 | MFS8 • MFS9.8                      | 664 |
| FILTRO DE ACEITE                     | 645 | JUNTAS BASE DE BOMBA             | 653 | GUÍA PIEZA DE COLA                 | 663 |
| FILTRO DE COMBUSTIBLE Y ELEMENTOS    | 644 | KITS DE REPARACIÓN BOMBA DE AGUA | 653 | OEM --> REF                        | 668 |
| FILTRO COMBUSTIBLE MONTAJE EN LÍNEA  | 644 | IMPULSORES                       | 652 | REF --> OEM                        | 670 |
| SISTEMA ELÉCTRICO                    | 646 | TERMOSTATO                       | 652 |                                    |     |
| BOBINAS                              | 647 | PARTES DEL MOTOR                 | 654 |                                    |     |
| ENCENDIDO                            | 647 | CIGÜEÑAL                         | 662 |                                    |     |
| PULSACIÓN                            | 647 | RODAMIENTOS                      | 662 |                                    |     |
| IGNICIÓN                             | 647 | DESPIECE MOTOR DE 4 TIEMPOS      | 657 |                                    |     |
| CARGA                                | 647 | MFS8 • MFS9.9                    | 657 |                                    |     |
| CDI Y CAJAS NEGRAS                   | 649 | DESPIECE MOTOR DE 2 TIEMPOS      | 654 |                                    |     |
| MOTORES DE ARRANQUE                  | 648 | M4C • M5B • M5BS                 | 654 |                                    |     |
| SENSORES                             | 646 | M6B • M8B • M9.8B                | 654 |                                    |     |
| SENSOR PRESIÓN ACEITE                | 646 | M9.9D • M15D2 • M18E2            | 655 |                                    |     |
| SENSOR DE OXIGENO                    | 646 | M25C3 • M30A4                    | 655 |                                    |     |
| SENSOR ÁRBOL DE LEVAS                | 646 | M40D2 • M50D2                    | 656 |                                    |     |
| TRIM, TILT & POWER TRIM              | 649 | JUNTAS DE MOTOR 4 TIEMPOS        | 660 |                                    |     |
| INSTALACIÓN ELÉCTRICA                | 649 | JUNTAS BASE DE MOTOR             | 660 |                                    |     |
| TRIM COMPLETO                        | 649 | JUNTAS DE CULATA                 | 660 |                                    |     |

# TOHATSU

## GUIDA MANTENIMIENTO

## MAINTENANCE GUIDE

|                      | REF           |                     |              |   |
|----------------------|---------------|---------------------|--------------|---|
| MFS4<br>MFS5<br>MFS6 | NGKDCPR6E     | BUJÍA               | SPARK PLUG   | 1 |
|                      | TEN01259      | ÁNODO               | ANODE DRIVE  | 1 |
|                      | CEF500377     | IMPULSOR            | IMPELLER     | 1 |
|                      | PAF4-05000300 | FILTRO COMBUSTIBLE  | FUEL FILTER  | 1 |
| MFS8<br>MFS9.8       | NGKDCPR6E     | BUJÍA               | SPARK PLUG   | 2 |
|                      | TEN01258      | ÁNODO BLOQUE        | ANODE ENGINE | 1 |
|                      | CEF500344     | IMPULSOR            | IMPELLER     | 1 |
|                      | PAF4-05000300 | FILTRO COMBUSTIBLE  | FUEL FILTER  | 1 |
|                      | REC855676002  | TERMOSTATO          | THERMOSTAT   | 1 |
|                      | PAF8-05000004 | CORREA DISTRIBUCIÓN | TIMING BELT  | 1 |
| TEN01260             | ÁNODO COLA    | ANODE DRIVE         | 1            |   |

|                          | REF             |                    |               |   |
|--------------------------|-----------------|--------------------|---------------|---|
| MFS9.9<br>MFS15<br>MFS18 | NGKDCPR6E       | BUJÍA              | SPARK PLUG    | 2 |
|                          | TEN01258        | ÁNODO BLOQUE       | ANODE ENGINE  | 1 |
|                          | CEF500383       | IMPULSOR           | IMPELLER      | 1 |
|                          | PAF4-05000300   | FILTRO COMBUSTIBLE | FUEL FILTER   | 1 |
| MFS25<br>MFS30           | REC855676002    | FILTRO ACEITE      | OIL FILTER    | 1 |
|                          | TEN01250        | ÁNODO TRANSOM      | TRANSOM ANODE | 1 |
|                          | NGKDCPR6E       | BUJÍA              | SPARK PLUG    | 2 |
|                          | TEN01258        | ÁNODO BLOQUE       | ANODE ENGINE  | 1 |
|                          | CEF500382       | IMPULSOR           | IMPELLER      | 1 |
|                          | PAF4-05000300   | FILTRO COMBUSTIBLE | FUEL FILTER   | 1 |
| MFS25<br>MFS30           | REC855676002    | TERMOSTATO         | THERMOSTAT    | 1 |
|                          | REC5GH-13440-00 | FILTRO ACEITE      | OIL FILTER    | 1 |
|                          | TEN01256        | ÁNODO TRANSOM      | TRANSOM ANODE | 1 |
|                          | TEN01253        | ÁNODO COLA         | ANODE DRIVE   | 1 |

TOHATSU

## SISTEMA DE ALIMENTACIÓN Y FILTRACIÓN FUEL & FILTRATION SYSTEM

### BOMBA DE COMBUSTIBLE

### FUEL PUMP

#### CONECTOR DE DEPÓSITO

#### TANK CONNECTOR

| REF     | OEM        |          | 2T<br>STROKES | 4T<br>STROKES | COMPATIBLE CON<br>COMPATIBLE WITH |
|---------|------------|----------|---------------|---------------|-----------------------------------|
| GS31019 | 99998-OMA2 | 1/4" NPT | ✓             | ✓             | GS31088                           |



| REF     | OEM         |      | 2T<br>STROKES | 4T<br>STROKES | COMPATIBLE CON<br>COMPATIBLE WITH |             |
|---------|-------------|------|---------------|---------------|-----------------------------------|-------------|
| GS31088 | 3B2-702501M | 3/8" | ✓             |               | GS31019                           | 5 --> 90 HP |



| REF     | OEM         |      | 2T<br>STROKES | 4T<br>STROKES |             |
|---------|-------------|------|---------------|---------------|-------------|
| GS31016 | 3B2-702801M | 3/8" | ✓             |               | 5 --> 90 HP |



| REF     | OEM         |         | 2T<br>STROKES | 4T<br>STROKES |             |
|---------|-------------|---------|---------------|---------------|-------------|
| GS31018 | 3B2-702601M | Metrica | ✓             |               | 5 --> 90 HP |



MEMBRANAS Y JUNTAS

DIAPHRAGMS & GASKETS

| REF        | OEM         |  |
|------------|-------------|-----------------------------------------------------------------------------------|
| REC8537312 | 350-04005-0 | M9.9D2<br>M15D2<br>M18E2<br>M40D2<br>M50D2                                        |

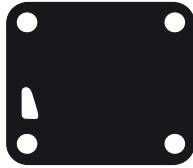

| REF B    | OEM         |  |
|----------|-------------|-------------------------------------------------------------------------------------|
| REC16325 | 369-03306-0 | M4C<br>M5B<br>M5BS<br>M6B<br>M8B<br>M9.8B                                           |



| REF A    | OEM         |  |
|----------|-------------|-----------------------------------------------------------------------------------|
| REC16275 | 369-03303-0 | M4C<br>M5B<br>M5BS<br>M6B<br>M8B<br>M9.8B                                         |



| REF A         | OEM         |  |
|---------------|-------------|-------------------------------------------------------------------------------------|
| REC27-8555691 | 3C8-04028-0 | M9.9D2<br>M15D2<br>M18E2<br>M40D2<br>M50D2                                          |



| REF A       | OEM         |  |
|-------------|-------------|-----------------------------------------------------------------------------------|
| REC27-16274 | 369-03302-0 | M4C<br>M5B<br>M5BS<br>M6B<br>M8B<br>M9.8B                                         |

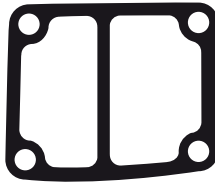

| REF A       | OEM         |  |
|-------------|-------------|-------------------------------------------------------------------------------------|
| REC27-16326 | 369-03307-0 | M4C<br>M5B<br>M5BS<br>M6B<br>M8B<br>M9.8B                                           |



FILTRO DE COMBUSTIBLE Y ELEMENTOS FUEL FILTERS AND ELEMENTS

FILTRO COMBUSTIBLE PARA MONTAJE EN LÍNEA

IN-LINE FUEL FILTER

| REF              | OEM            |  |
|------------------|----------------|-------------------------------------------------------------------------------------|
| REC16911-ZZ5-003 | HZZ5-16911-003 | BFTW60A<br>BFT60A                                                                   |





| REF            | OEM         |  |
|----------------|-------------|---------------------------------------------------------------------------------------|
| PAF15-07080000 | 3AC-02230-0 | MFS25                                                                                 |
|                | 3AD-02230-0 | MFS25B                                                                                |
|                | 3B7-02230-0 | MFS30                                                                                 |



| REF              | OEM            |  |
|------------------|----------------|-------------------------------------------------------------------------------------|
| REC16911-ZY3-010 | HZY3-16911-010 | BFT75AK1                                                                            |
|                  |                | BFT90AK1                                                                            |
|                  |                | BFT115A                                                                             |
|                  |                | BFT250A                                                                             |
|                  |                | BFT225A                                                                             |
|                  |                | BFT200A                                                                             |
|                  |                | BFT150A                                                                             |



| REF      | OEM   |  |  |  |
|----------|-------|---------------------------------------------------------------------------------------|---------------------------------------------------------------------------------------|---------------------------------------------------------------------------------------|
| REC40145 | 40145 | 1/4"                                                                                  | 1/4"                                                                                  | plástico<br>plastic                                                                   |
| REC40155 | 40155 | 5/16"                                                                                 | 5/16"                                                                                 |                                                                                       |
| REC40165 | 40165 | 3/8"                                                                                  | 3/8"                                                                                  |                                                                                       |
| REC40135 | 40135 | 5/16"                                                                                 | 3/8"                                                                                  |                                                                                       |



| REF           | OEM                        |  |
|---------------|----------------------------|-------------------------------------------------------------------------------------|
| PAF4-05000300 | 346-02230-0<br>366-02230-0 | M5 MFS4                                                                             |
|               |                            | M9.8 MFS5                                                                           |
|               |                            | M9.9 MFS6                                                                           |
|               |                            | M15 MFS8                                                                            |
|               |                            | M18 MFS9.9                                                                          |
|               |                            | M40 MFS15                                                                           |
|               |                            | MFS20                                                                               |
|               |                            | MFS30                                                                               |





| REF          |                              |
|--------------|-------------------------------------------------------------------------------------------------------------------|
| REC35-80365M | 6 (1989, 1992-99)<br>8 (1989-99, 2001-02)<br>F4 (1999-02)<br>F9.9 (1989-95, 1997-99, 2001-02)<br>FT 9.9 (1988-90) |





## FILTRO DE ACEITE

## OIL FILTER

| REF             | OEM          | 4T<br>STROKES |  |
|-----------------|--------------|---------------|-----------------------------------------------------------------------------------|
| REC5GH-13440-00 | 3R3R76150M   | ✓             |  |
|                 | 3R0-07615-0  |               |                                                                                   |
|                 | 5GH-13440-00 |               |                                                                                   |
|                 | MFS15        |               |                                                                                   |
|                 | MFS20        |               |                                                                                   |
|                 | MFS20        |               |                                                                                   |
|                 | MFS30        |               |                                                                                   |
|                 | MFS40        |               |                                                                                   |
|                 | MFS50        |               |                                                                                   |
|                 | MFS60        |               |                                                                                   |



| REF              | OEM           |  |
|------------------|---------------|-------------------------------------------------------------------------------------|
| REC15400-RBA-F01 | HPLM-15400-A0 |  |
|                  | HPLM-15400-PE |                                                                                     |
|                  | BFT75AK1      |                                                                                     |
|                  | BFT90AK1      |                                                                                     |
|                  | BFT225A       |                                                                                     |
|                  | BFT250A       |                                                                                     |
|                  | BFT200A       |                                                                                     |
|                  | BFT150A       |                                                                                     |
|                  | BFT115A       |                                                                                     |





## CARBURADOR

## CARBURATOR

### CARBURADOR COMPLETO



### FULL CARBURATOR

| REF           | OEM         | 4T<br>STROKES |  |
|---------------|-------------|---------------|-----------------------------------------------------------------------------------|
| PAF8-05040000 | 3FS-03100-0 | ✓             |  |
|               | 3V2-03100-2 |               |                                                                                   |
|               | MFS8        |               |                                                                                   |
|               | MFS9.8HP    |               |                                                                                   |





### KITS CARBURADORES

### CARBURETOR KITS

| REF             | OEM         |  |       |
|-----------------|-------------|-------------------------------------------------------------------------------------|-------|
| REC6H3-W0093-02 | 346-87122-0 |  |       |
|                 |             |                                                                                     | 45A2  |
|                 |             |                                                                                     | 50C   |
|                 |             |                                                                                     | 60C   |
|                 |             |                                                                                     | 70A2  |
|                 |             |                                                                                     | M25C3 |
|                 | M30A4       |                                                                                     |       |





| REF                | OEM         |  |
|--------------------|-------------|---------------------------------------------------------------------------------------|
| REC6H1-W0093-01-00 | 346-87122-0 | M25<br>M30                                                                            |





| REF             | OEM         |  |
|-----------------|-------------|-------------------------------------------------------------------------------------|
| REC6H4-W0093-03 | 3F3-87122-1 | M70                                                                                 |



| REF             | OEM                        |  |
|-----------------|----------------------------|---------------------------------------------------------------------------------------|
| REC6G1-W0093-00 | 369-87122-1<br>3B2-87122-0 | M4                                                                                    |
|                 |                            | 5B<br>M5                                                                              |
|                 |                            | 8B<br>M6                                                                              |
|                 | 9.8<br>M8                  |                                                                                       |
|                 |                            | M9.8                                                                                  |



| REF             | OEM         |  |
|-----------------|-------------|---------------------------------------------------------------------------------------|
| REC66M-W0093-01 | 3V1-87122-0 | MFS8<br>MFS9                                                                          |



**KITS 2 CARBURADORES**

**KITS FOR 2 CARBURETORS**

| REF             | OEM                        |  |
|-----------------|----------------------------|-----------------------------------------------------------------------------------|
| REC6L2-W0093-00 | 3C8-87122-2<br>3G2-87122-2 | M50<br>M15<br>M18                                                                 |

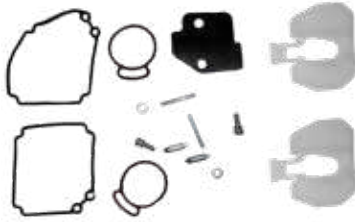

**BOYAS**

**FLOATS**

| REF       | OEM         |  |
|-----------|-------------|-----------------------------------------------------------------------------------|
| REC162532 | 3C8-03125-0 | M9.9D2<br>M15D2<br>M18W2<br>M40D2<br>M50D2<br>MF8,<br>9.8A-A2-A3<br>MFS15C        |



| REF      | OEM         |  |
|----------|-------------|-------------------------------------------------------------------------------------|
| REC16253 | 369-03231-0 | M4B<br>M5B<br>M5BS<br>M6B<br>M8B<br>M9.8B                                           |



**SISTEMA ELÉCTRICO**

**ELECTRIC SYSTEM**

**SENSORES**

**SENSORS**

**SENSOR PRESIÓN DE ACEITE**

**OIL PRESURE SENSOR**

| REF            | OEM         |  |
|----------------|-------------|-------------------------------------------------------------------------------------|
| PAF15-07010100 | 3H6-07611-0 | MFS4 --> MFS40 HP                                                                   |



**SENSOR DE OXÍGENO**

**OXYGEN SENSOR**

| REF              | OEM            |  |
|------------------|----------------|-------------------------------------------------------------------------------------|
| REC35668-ZY6-003 | HZY6-35668-003 | BFT150A<br>BFT115A                                                                  |



**SENSOR POSICIÓN ÁRBOL DE LEVAS**

**CAMSHAFT SENSOR**

| REF              | OEM            |  |
|------------------|----------------|-------------------------------------------------------------------------------------|
| REC37510-PNB-003 | HPNB-37510-003 | BFT150A<br>BFT115A                                                                  |



# BOBINAS

# COILS

## BOBINA

## COIL

| REF           | OEM         |  |
|---------------|-------------|-----------------------------------------------------------------------------------|
| PAF8-05000300 | 3AA-06021-0 | MFS8<br>MFS9.8                                                                    |



| REF            | OEM         |  |
|----------------|-------------|-------------------------------------------------------------------------------------|
| REC3G3-06021-1 | 3G3-06021-1 | M9.9D2<br>M15D2<br>M18E2<br>M25C3<br>M30A4                                          |



| REF            | OEM         |  |
|----------------|-------------|-----------------------------------------------------------------------------------|
| REC369-06021-0 | 369-06021-0 | M4C<br>M5B-BS                                                                     |



## BOBINA ENCENDIDO

## STARTER COIL

| REF           | OEM                                    |  |
|---------------|----------------------------------------|-----------------------------------------------------------------------------------|
| PAF8-05000500 | 3V1-06040-0<br>3V1060400<br>3V1060400M | MFS8<br>MFS9.8                                                                    |



## BOBINA DE PULSACIÓN

## PULSER COIL

| REF           | OEM         |  |
|---------------|-------------|-------------------------------------------------------------------------------------|
| PAF8-05000200 | 3V1-06071-0 | MFS8<br>MFS9.8                                                                      |



## BOBINA DE IGNICIÓN

## COIL IGNITION

| REF            | OEM         |  |
|----------------|-------------|-------------------------------------------------------------------------------------|
| REC3A0-06040-1 | 3A0-06040-1 | M25C3<br>M30A4                                                                      |



| REF            | OEM         |  |
|----------------|-------------|---------------------------------------------------------------------------------------|
| REC3G2-06040-2 | 3G2-06040-2 | M9.9D2<br>M15D2<br>M18E2                                                              |



| REF              | OEM            |  |
|------------------|----------------|-------------------------------------------------------------------------------------|
| REC30580-ZV4-013 | HZV4-30580-013 | BFT75AKI<br>BFT90AKI                                                                |



## BOBINA DE CARGA

## CHARGER COIL

| REF            | OEM         |  |
|----------------|-------------|-------------------------------------------------------------------------------------|
| PAF8-05090000W | 3V1-06023-0 | MFS8<br>MFS9.8                                                                      |



## MOTORES DE ARRANQUE

## STARTERS

| REF             | OEM                                    | ⚡             | ☀️    | 2T<br>STROKES | 4T<br>STROKES | 🔧                                                                                                  |
|-----------------|----------------------------------------|---------------|-------|---------------|---------------|----------------------------------------------------------------------------------------------------|
| REC50-8M0147039 | 3C8-76010-1<br>3C8760101<br>3C8760101M | 12V<br>0.6 kw | 9 CCW | ✓             | ✓             | M40D2/B2<br>M50D2/B2<br>M70C<br>MFS9.9B2-C<br>MFS15B2-C<br>MFS18B2<br>MFS20C<br>MFS25A-B<br>MFS30B |



| REF             | OEM         | ☀️ | 2T<br>STROKES | 4T<br>STROKES | 🔧                                                 |
|-----------------|-------------|----|---------------|---------------|---------------------------------------------------|
| REC353-76010-4M | 353-76010-4 | 9  | ✓             |               | MD70B<br>MD90B<br>MD115A-A2<br>MD120A2<br>MD140A2 |



### PMGR

| REF            | OEM                                                        | ⚡          | ☀️    | 2T<br>STROKES | 4T<br>STROKES | 🔧                                                                                                        |
|----------------|------------------------------------------------------------|------------|-------|---------------|---------------|----------------------------------------------------------------------------------------------------------|
| REC3KY-76010-0 | 3KY-76010-0<br>3KY-76010-1<br>3KY-76010-0M<br>3KY-76010-1M | 12V 1.4 kw | 9 CCW |               | ✓             | MFS40A (2013+)<br>MFS50A (2013+)<br>MFS60A (2019+)<br>MFS75A (2020+)<br>MFS90A, MFS115A, MFS140A (2020+) |



| REF             | OEM                                           | 2T<br>STROKES | 4T<br>STROKES          | 🔧 |
|-----------------|-----------------------------------------------|---------------|------------------------|---|
| REC346-76010-0M | 346-76010-0,<br>346-76010-0A0<br>346-76010-0M | ✓             | M25C3<br>M30A4<br>M40C |   |



| REF              | OEM            | 2T<br>STROKES | 4T<br>STROKES | 🔧                  |
|------------------|----------------|---------------|---------------|--------------------|
| REC31200-ZY6-003 | HZY6-31200-003 |               | ✓             | BFT150A<br>BFT115A |



| REF              | OEM            | 2T<br>STROKES | 4T<br>STROKES | 🔧                             |
|------------------|----------------|---------------|---------------|-------------------------------|
| REC31200-ZY3-003 | HZY3-31200-003 |               | ✓             | BFT250A<br>BFT225A<br>BFT200A |



## DESCONECTADORES INTERRUPTORES

## CUT OFF SWITCHES

### INTERRUPTOR

### SWITCHES

| REF          | OEM       |
|--------------|-----------|
| REC3A3725600 | 3A3725600 |



## INTERRUPTOR LLAVE PRINCIPAL

## MAIN KEY SWITCH

| REF          | OEM       |
|--------------|-----------|
| REC353760203 | 353760203 |



## DESCONECTOR DE SEGURIDAD

## CUT OFF SWITCHES

| REF           | OEM        |
|---------------|------------|
| REC369-0682-0 | 369-0682-0 |



| REF          | OEM       |
|--------------|-----------|
| REC3A3068300 | 3A3068300 |



## CDI Y CAJAS NEGRAS

## CDI & POWER PACK

| REF            | OEM         |  |
|----------------|-------------|-----------------------------------------------------------------------------------|
| REC3G2-06060-2 | 3G2-06060-2 | M9.9D2<br>B15D2<br>M18E2                                                          |



| REF           | OEM                        |  |
|---------------|----------------------------|-------------------------------------------------------------------------------------|
| PAF8-05000400 | 3AA-06060-00<br>3AA060600M | MFS8<br>BFS9.8                                                                      |



## TRIM, TILT & POWER TRIM

### INSTALACIÓN ELÉCTRICA

### WIRING HARNESS

**KIT CONVERSIÓN**  
Sustituye de 2 a 3 cables.

| REF             |
|-----------------|
| REC84-819514T26 |



**CONVERSION KIT**  
Converts 3-wire Tilt and Trim motors to 2-Wire design

### TRIM COMPLETO

### COMPLETE TRIM ASSEMBLY

| REF                |  |  |  | 2T<br>STROKES | 4T<br>STROKES |  |
|--------------------|-------------------------------------------------------------------------------------|-------------------------------------------------------------------------------------|-------------------------------------------------------------------------------------|---------------|---------------|-------------------------------------------------------------------------------------|
| REC38100-87D10-0ED | 12V                                                                                 | 3                                                                                   | 2                                                                                   | ✓             |               | V4, V6 (1990-03)                                                                    |



# SISTEMA DE GOBIERNO

# STEERING SYSTEM

## MANDOS DE CONTROL

## ENGINE CONTROLS

### MANDO PARA CONSOLA

### CONSOLE CONTROL

| REF              | OEM            | POWER TRIM |  |
|------------------|----------------|------------|-----------------------------------------------------------------------------------|
| REC06240-ZZ3-R30 | HZZ3-06240-R30 | ✓          | MF840 TO 250                                                                      |
| REC06240-ZZ3-R40 | HZZ3-06240-R40 | ✓          |                                                                                   |



### MANDO LATERAL

### SIDE CONTROL

| REF           | OEM        | POWER TRIM |  |
|---------------|------------|------------|-------------------------------------------------------------------------------------|
| REC3ACQ843301 | 3ACQ843301 | ✓          | MFS 8C-30C/M40, 90<br>ALL TLDI MFS40/50A                                            |
| REC3GFQ845001 | 3GFQ845001 |            |                                                                                     |



| REF          | OEM       | POWER TRIM |                                |                |
|--------------|-----------|------------|--------------------------------|----------------|
| RECEU3849900 | EU3849900 | ✓          | CH X 8 171P<br>Single Binnacle | MFS9.9 TO 60HP |



KITS CONTROL REMOTO

REMOTE CONTROL KIT

| REF            | OEM         |
|----------------|-------------|
| REC389-83880-1 | 389-83880-1 |



COMPONENTES

COMPONENTS

CABLE DE ACELERADOR

THROTTLE CABLE

| REF       | OEM         |                     |
|-----------|-------------|---------------------|
| REC804898 | 3B2-63600-1 | M6B<br>M8B<br>M9.8B |



# SISTEMA DE REFRIGERACIÓN

# COOLING SYSTEM

## IMPULSORES

## IMPELLERS

### GUÍA DE IMPULSORES

### IMPELLER GUIDE

|  2T STROKES | REF            | OEM         | A (mm) | B (mm) | C (mm) |
|----------------------------------------------------------------------------------------------|----------------|-------------|--------|--------|--------|
| 6 / 8 / 9.8 HP                                                                               | REC3B2-65021-1 | 3B2-65021-1 | 12,1   | 40     | 18     |
| 25 / 30 / 35 HP                                                                              | REC345-65021-0 | 345-65021-0 | 17,12  | 44,1   | 20,25  |
| 40 / 50 HP                                                                                   | REC3C8-65021-2 | 3C8-65021-2 | 50,4   | 20,15  | 17,20  |
| 60 / 70 / 90 HP                                                                              | REC3B7-65021-2 | 3B7-65021-2 | 20,15  | 67,4   | 35,1   |

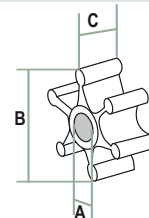

|  4T STROKES | REF              | OEM            | A (mm) | B (mm) | C (mm) |
|----------------------------------------------------------------------------------------------|------------------|----------------|--------|--------|--------|
| MFS8, 9.8 HP                                                                                 | REC3B2-65021-1   | 3B2-65021-1    | 12,1   | 40     | 18     |
| MFS25, 30HP                                                                                  | REC345-65021-0   | 345-65021-0    | 17,12  | 44,1   | 20,25  |
| BFTW60A<br>BT60A                                                                             | REC19210-ZV5-003 | HZV5-19210-003 | 17,20  | 55,90  | 20,20  |
| BFT115A / 150A                                                                               | REC19210-ZW1-B02 | HZW1-19210-B04 | 23,35  | 87,80  | 31,00  |
| BFT200A / 225A<br>BFT250A                                                                    | REC19210-ZY3-003 | HZY3-19210-003 | 26     | 89,75  | 31,30  |



## TERMOSTATO

## THERMOSTAT

### TERMOSTATO

### THERMOSTAT

| REF          | OEM         | °C  |  |
|--------------|-------------|-----|-------------------------------------------------------------------------------------|
| REC855676002 | 3R3-01030-0 | 60° | MFS8<br>MFS30                                                                       |



| REF              | OEM            |  |
|------------------|----------------|---------------------------------------------------------------------------------------|
| REC19300-ZV5-043 | HZV5-19300-043 | BFT115A<br>BFT130A<br>BFT150A                                                         |



| REF            | OEM            |  |
|----------------|----------------|-------------------------------------------------------------------------------------|
| PAF15-07000031 | HZW9-19300-003 | BFT90AK1<br>BFT75AK1<br>BFT60A<br>BFTW60A                                           |



## ÁNODOS

## ANODES

| REF                 | OEM          |  |
|---------------------|--------------|-------------------------------------------------------------------------------------|
| AL REC3B7-60217-0AL | 3B7-60217-0  | 25-50hp<br>2 stroke                                                                 |
| ZN REC3B7-60217-0   | 3B7-60217-0M | 25-50hp<br>4 stroke                                                                 |



| REF                 | OEM         |  |
|---------------------|-------------|---------------------------------------------------------------------------------------|
| AL REC3M2-60218-0AL | 3M2-60218-0 | 40-140hp                                                                              |
| ZN REC3M2-60218-0   | 3M2-60218-0 |                                                                                       |



# BOMBA DE AGUA

# WATER PUMP

## JUNTA BASE DE BOMBA

## WATER PUMP, GASKET BASE

| REF           | OEM         |  |
|---------------|-------------|-----------------------------------------------------------------------------------|
| PAF8-04000007 | 3B2-65025-0 | MD9.9D2<br>MD15D2<br>MD18E2<br>S9.9B2-C<br>MFS15C<br>MFS18B2<br>MFS20C            |



| REF      | OEM         |  |
|----------|-------------|-------------------------------------------------------------------------------------|
| REC16159 | 369-65025-0 | MFS4A2-B-C<br>MFS5A2-B-C<br>MFS4A2-B-C                                              |



## JUNTAS BOMBA

## WATER PUMP GASKET

| REF            | OEM         |  |
|----------------|-------------|-----------------------------------------------------------------------------------|
| REC3F0-65029-0 | 3F0-65029-6 | M3.2B2<br>MFS2.5B<br>MFS3.5B<br>MFS2A                                             |



## CASQUILLO INOX

## INSERT CUP

| REF       | OEM         |  |
|-----------|-------------|-----------------------------------------------------------------------------------|
| REC803751 | 350-65011-1 | M9.9D2<br>M15D2<br>M18E2<br>MFS9.9C, B2<br>MSF15C, B2<br>MSF20C<br>MSF18B2        |



| REF           | OEM         |  |
|---------------|-------------|-------------------------------------------------------------------------------------|
| PAF8-04000010 | 3B2-65011-0 | M6<br>M8<br>M9.8B<br>MFS8, A - A2 -A3<br>MFS9.8A - A2 -A3                           |



| REF      | OEM         |  |
|----------|-------------|-------------------------------------------------------------------------------------|
| REC16157 | 369-65011-0 | M4B<br>M5B<br>M5B5<br>MFS4, 5, 6 -A2                                                |

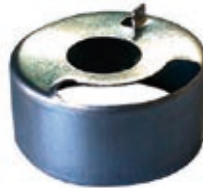

## KITS DE REPARACIÓN BOMBA DE AGUA

## WATER PUMP SERVICE KITS

| REF              | OEM            |  |
|------------------|----------------|-------------------------------------------------------------------------------------|
| REC06192-ZY6-000 | HZY6-06192-000 | BFT150<br>BFT115A                                                                   |

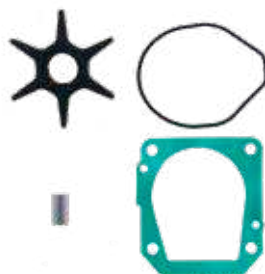

| REF              | OEM            |  |
|------------------|----------------|---------------------------------------------------------------------------------------|
| REC06192-ZY3-000 | HZY3-06192-000 | BFT200A<br>BFT225A                                                                    |



# PARTES DEL MOTOR

# ENGINE PARTS

## DESPIECE MOTOR DE 2 TIEMPOS

## ENGINE PARTS 2 STROKES

2T M4C • M5B • M5BS  
STROKES

|   | REF          | OEM         |                   |                 | UN. |
|---|--------------|-------------|-------------------|-----------------|-----|
| 1 | REC26-16051  | 369-00122-0 | RETÉN ACEITE      | OIL SEAL        | 2   |
| 2 | REC30-16049  | 9603-3-6204 | RODAMIENTO        | BALL BEARING    | 2   |
| 3 | REC31-813048 | 369-00043-0 | COJINETE DE AGUJA | NEEDLE BEARING  | 1   |
| 4 | REC813046002 | 369-00061-0 | PIN               | CRANK PIN       | 1   |
| 5 | REC53-16057  | 350-00024-1 | CLIP              | CLIP            | 2   |
| 6 | REC31-16052  | 350-00042-0 | COJINETE DE AGUJA | NEEDLE BEARING  | 1   |
| 7 | REC41-16056  | 369-00021-0 | PIN               | PISTON PIN      | 1   |
| 8 | REC779-9615T | 369-00001-0 | PISTÓN STD        | PISTON STD      | 1   |
| 9 | REC8M0080357 | 351-00011-0 | KIT SEGMENTOS     | PISTON RING KIT | 2   |

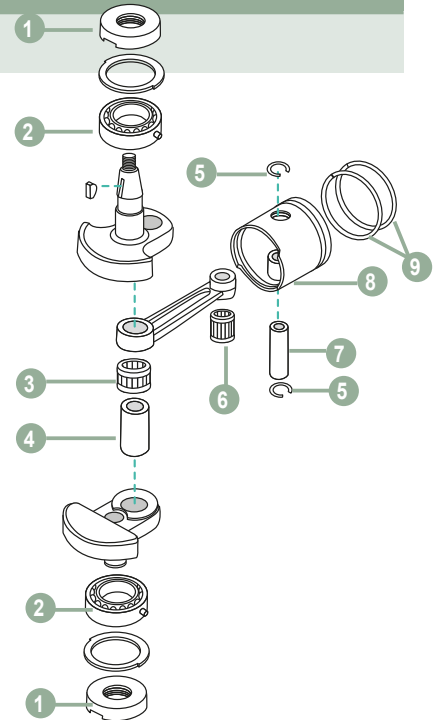

2T M6B • M8B • M9.8B  
STROKES

|    | REF            | OEM         |                   |                 | UN. |
|----|----------------|-------------|-------------------|-----------------|-----|
| 1  | REC26-803514   | 101-00121-0 | RETÉN ACEITE      | OIL SEAL        | 1   |
| 2  | REC30-16049    | 9603-3-6204 | RODAMIENTO        | BALL BEARING    | 2   |
| 3  | REC41-8036801  | 3B2-00021-0 | PIN               | PISTON PIN      | 2   |
| 4  | REC629-8036741 | 3B2-00040-0 | BIELA             | CONNECTING ROD  | 2   |
| 5  | REC30-16049    | 9603-3-6204 | RODAMIENTO        | BALL BEARING    | 1   |
| 6  | REC26-85370711 | 3B2-00051-0 | RETÉN ACEITE      | OIL SEAL        | 1   |
| 7  | REC31-8036752  | 338-00042-0 | COJINETE DE AGUJA | NEEDLE BEARING  | 2   |
| 8  | REC53-16057    | 350-00024-1 | CLIP              | CLIP            | 2   |
| 9  | REC779-804886  | 3B2-00001-0 | PISTÓN STD        | PISTON STD      | 2   |
| 10 | REC39-803678A3 | 3B2-00011-0 | KIT SEGMENTOS     | PISTON RING KIT | 4   |

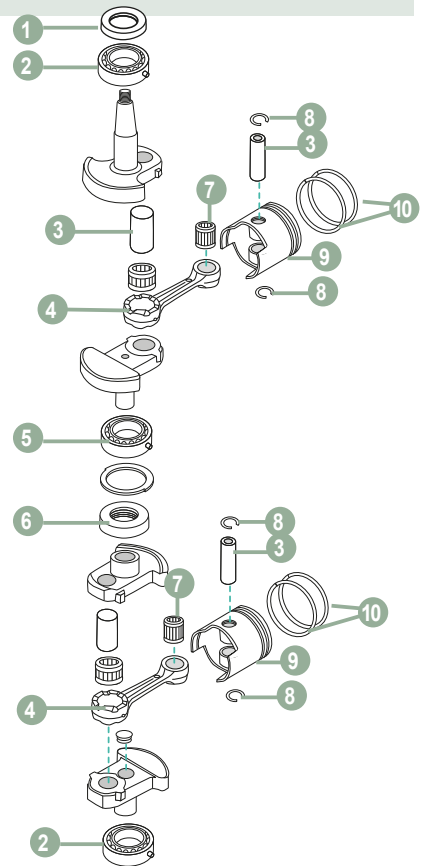

2T  
STROKES

M9.9D • M15D2 • M18E2

|   | REF              | OEM          |                              | UN.                            |   |
|---|------------------|--------------|------------------------------|--------------------------------|---|
| 1 | REC30-160494     | 96603-3-6305 | RODAMIENTO                   | BALL BEARING                   | 3 |
| 2 | REC803673        | 350-00061-0  | PIN                          | CRANK PIN                      | 2 |
| 3 | REC629-803674    | 350-00040-0  | BIELA                        | CONNECTING ROD                 | 2 |
| 4 | REC31-16052      | 350-00042-0  | COJINETE DE AGUJA            | NEEDLE BEARING                 | 2 |
| 5 | REC53-16057      | 350-00024-1  | CLIP                         | CLIP                           | 4 |
| 6 | REC41-803680002  | 350-00021-0  | PIN 18 HP                    | PISTON PIN 18 HP               | 2 |
|   | REC41-825713002  | 332-00021-0  | PIN 9.9 / 15 HP              | PISTON PIN 9.9 / 15 HP         | 2 |
| 7 | REC779-803677T02 | 351-00001-1  | PISTÓN STD,<br>9.9 / 15 HP   | PISTON STD 9.9 / 15 HP         | 1 |
|   | REC779-803677    | 350-00001-1  | PISTÓN STD 18 HPP            | PISTON STD HP                  | 1 |
|   | REC39-803678A1   | 350-00011-0  | KIT SEGMENTOS<br>18 HP       | PISTON RING KIT<br>18 HP       | 2 |
| 8 | REC8M0080357     | 351-00011-0  | KIT SEGMENTOS<br>9.9 / 15 HP | PISTON RING KIT<br>9.9 / 15 HP | 2 |

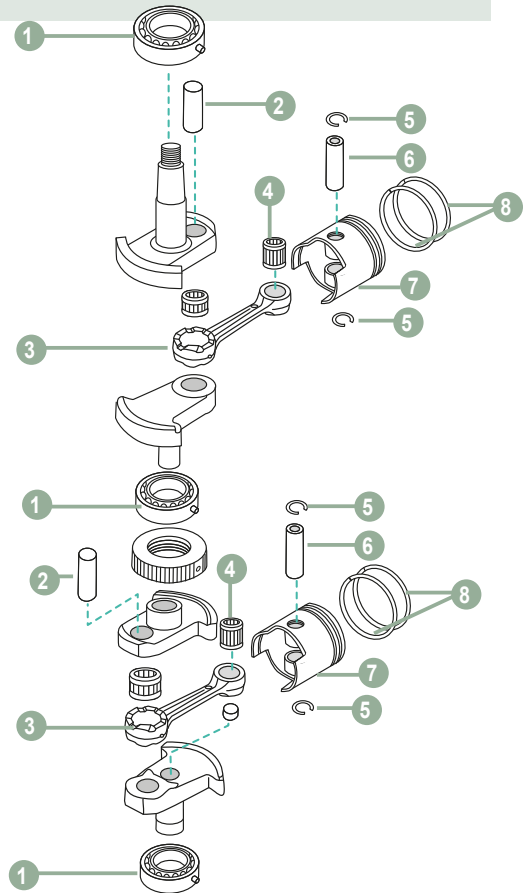

2T  
STROKES

M25C3 • M30A4

|   | REF              | OEM         |                   | UN.             |   |
|---|------------------|-------------|-------------------|-----------------|---|
| 1 | REC30-16049T01   | 345-00113-0 | RODAMIENTO        | BALL BEARING    | 1 |
| 2 | REC8130461       | 334-00061-0 | PIN               | CRANK PIN       | 2 |
| 3 | REC31-8130482    | 356-00043-0 | COJINETE DE AGUJA | NEEDLE BEARING  | 2 |
| 4 | REC629-813047T01 | 336-00040-1 | BIELA             | CONNECTING ROD  | 2 |
| 5 | REC345-00042-0   | 345-00042-0 | COJINETE DE AGUJA | NEEDLE BEARING  | 1 |
| 6 | REC53-16057      | 334-00024-1 | CLIP              | CLIP            | 4 |
| 7 | REC41-803680003  | 3C8-00021-0 | PIN               | PISTON PIN      | 2 |
| 8 | REC779-879194T01 | 346-00001-1 | PISTÓN STD        | PISTON STD      | 2 |
| 9 | REC39-16054A5    | 346-00011-0 | KIT SEGMENTOS     | PISTON RING KIT | 4 |

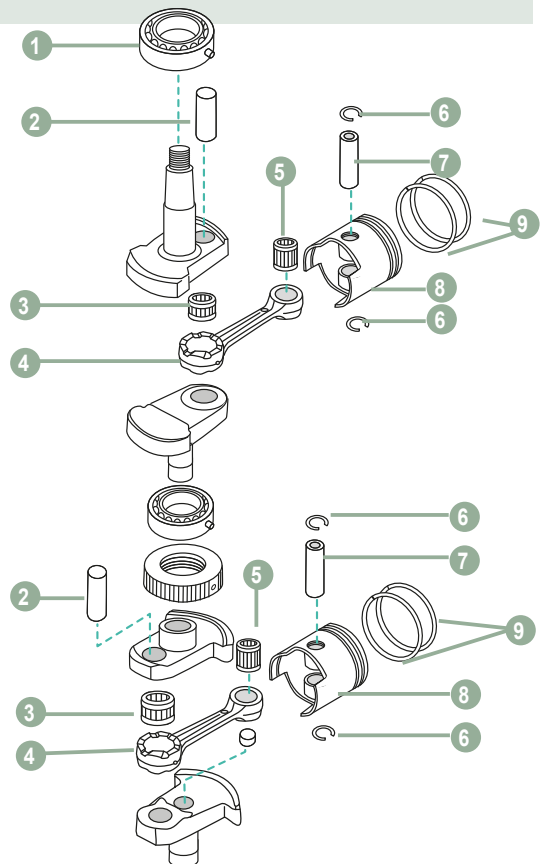

TOHATSU

RECMAR®

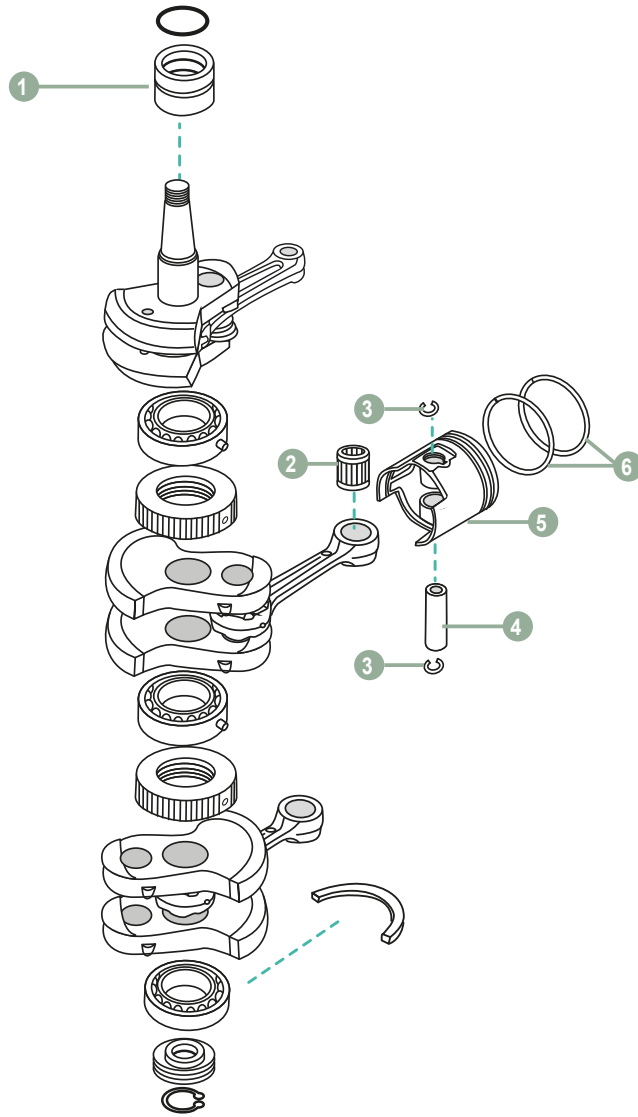

|   | REF            | OEM         |                   |                    | UN. |
|---|----------------|-------------|-------------------|--------------------|-----|
| 1 | REC31-855553   | 3C8-00113-0 | RODAMIENTO SUP.   | MAIN BEARING UPPER | 1   |
| 2 | REC345-00042-0 | 345-00042-0 | COJINETE DE AGUJA | NEEDLE BEARING     | 3   |
| 3 | REC53-16057    | 334-00024-1 | CLIP              | CLIP               | 6   |
| 4 | REC41-16056    | 3C8-00021-0 | PIN               | PISTON PIN         | 3   |
| 5 | REC779-9615T   | 3C8-00001-3 | PISTÓN STD        | PISTON STD         | 3   |
| 6 | REC8M0080349   | 346-00011-0 | KIT SEGMENTOS     | PISTON RING KIT    | 6   |

# DESPIECE MOTOR DE 4 TIEMPOS

# ENGINE PARTS 4 STROKES

4T MFS8 • MFS9.9  
STROKES

|    | REF            | OEM         |                       |                      |
|----|----------------|-------------|-----------------------|----------------------|
| 1  | PAF8-05000024  | 369-00132-0 | TUERCA                | NUT, FLYWHEEL        |
| 2  | PAT15-04000011 | 940121-1200 | ARANDELA              | WASHER, FLYWHEEL NUT |
| 3  | PAF8-05000600  | 3AA-06091-0 | EJE DE VOLANTE        | FLYWHEEL ASSY        |
| 4  | PAF8-05000200  | 3V1-06071-0 | BOBINA PULSACIÓN      | COIL PULSER          |
| 5  | PAF8-05000021  | 3R0-66308-0 | ARANDELA              | WASHER               |
| 6  | PAF8-05000011  | 3T5-06920-0 | AMORTIGUADOR (B)      | ABSORBER (B) CDI     |
| 7  | PAF8-05000006  | 3A0-76079-0 | MANGUERA              | TUBE                 |
| 8  | PAF8-05000400  | 3AA-06060-0 | CDI                   | CDI                  |
| 9  | PAF15-07010101 | 3H6-07612-0 | AISLANTE              | JACKET INSULATION    |
| 10 | PAF15-07010100 | 3H6-07611-0 | SENSOR PRESIÓN ACEITE | OIL PRESSURE SENSOR  |
| 11 | PAF8-05000500  | 3V1-06040-0 | BOBINA ENCENDIDO      | STARTER COIL ASSY    |
| 12 | PAF8-05000300  | 3AA-06021-0 | BOBINA                | COIL                 |

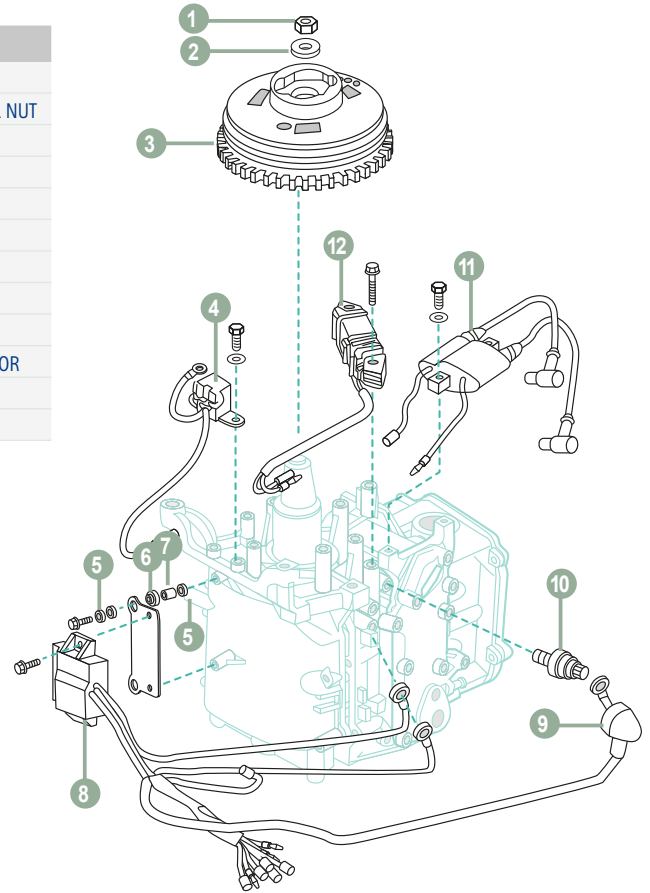

4T MFS8 • MFS9.9  
STROKES

|    | REF           | OEM         |              |                  |
|----|---------------|-------------|--------------|------------------|
| 1  | PAF8-05000003 | 172-36008-0 | RETÉN        | RUBBER GROMMET A |
| 2  | PAF8-05000012 | 3V1-06308-0 | TAPA         | COVER, STRAP     |
| 3  | PAF8-05000013 | 3V1-06302-0 | RETÉN        | RUBBER GROMMET B |
| 4  | PAF4-04130101 | 3AA-05019-0 | TIRADOR      | HANDLE, STARTER  |
| 5  | PAF4-04130100 | 3R1-05131-0 | TAPA         | COVER, HANDLE    |
| 6  | PAF8-05050002 | 3V1-05259-0 | ARANDELA     | WASHER, THRUST   |
| 7  | PAF8-05050003 | 3R1-05125-0 | MUELLE       | SPRING CASE      |
| 8  | PAF8-05050004 | 3AA-05004-0 | MUELLE       | VOLUTE SPRING    |
| 9  | PAF8-05050018 | 3AA-05013-0 | CUERDA       | START LINE       |
| 10 | PAF8-05050005 | 3V1-05104-1 | VOLANTE      | WHEEL, START-UP  |
| 11 | PAF8-05050007 | 3R1-05012-0 | MUELLE       | SPRING, TENSION  |
| 12 | PAF8-05050006 | 3R1-05003-1 | UÑA PLÁSTICA | PAWL, DRIVE      |
| 13 | PAF8-05050009 | 3R1-05007-0 | MUELLE       | SPRING PLATE     |

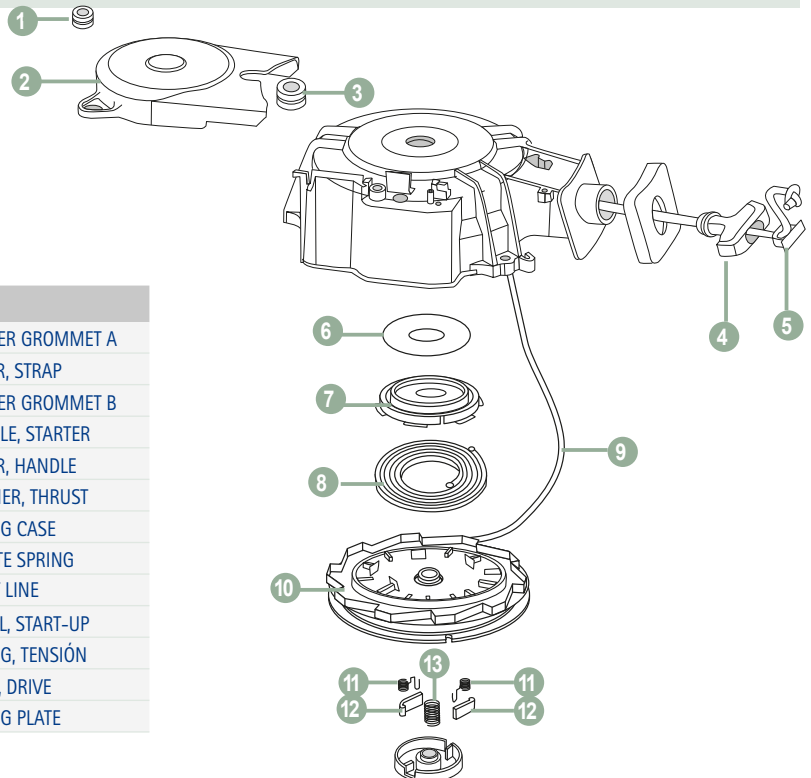

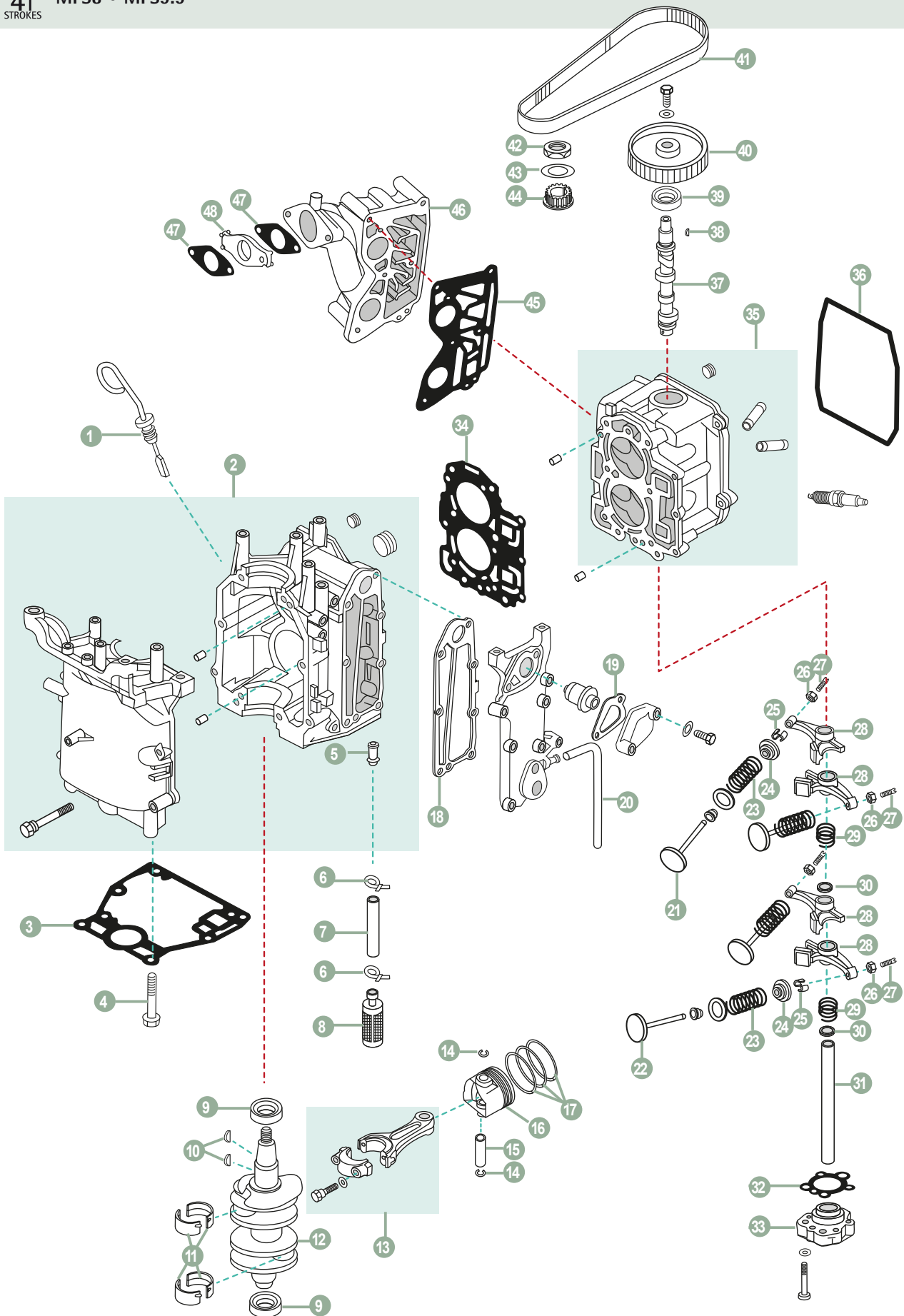



|    | REF             | OEM         |                       |                            |
|----|-----------------|-------------|-----------------------|----------------------------|
| 1  | PAF8-0000200    | 3V1-07421-0 | MEDIDOR NIVEL ACEITE  | OIL LEVEL GAUGE            |
| 2  | PAF8-05010000   | 3V1B01100-0 | BLOQUE COMPLETO       | CRANKCASSE ASSY            |
| 3  | PAF8-00000004   | 3V1-01303-0 | JUNTA BASE MOTOR      | GASKET, ENGINE BASEMENT    |
| 4  | PAF8-00000003   | 3R3-61017-0 | TORNILLO M8x35        | BOLT M8x35                 |
| 5  | PAF8-05010002   | 3H8-02093-0 | RACORD                | NIPPLE                     |
| 6  | PAF8-05000025   | 369-84398-0 | CLIP                  | HOOP                       |
| 7  | PAF8-05000017   | 98AH10-0120 | MANGUERA              | HOSE                       |
| 8  | PAF8-05000800   | 3V1-07410-0 | FILTRO ACEITE         | OIL STRAINER               |
| 9  | PAF8-05010012   | 3V1-00121-0 | RETÉN ACEITE          | OIL SEAL                   |
| 10 | PAF4-04000019   | 3T5-10131-0 | CHAVETA               | KEY                        |
| 11 | PAF8-05010009   | 3V1-07407-0 | COJINETE              | BUSH                       |
| 12 | PAF8-05020001   | 3V1-00030-1 | CIGÜEÑAL              | CRANK                      |
| 13 | PAF8-05020200   | 3V1-00040-0 | BIELA                 | CONNENCTING ROD            |
| 14 | PAF15-07020005  | 350-00024-1 | CLIP                  | CIRCLIP                    |
| 15 | PAF8-05020105   | 332-00021-0 | PIN                   | PIN, PISTON                |
| 16 | PAF8-05020101   | 3V1-00001-0 | PISTON                | PISTON                     |
| 17 | REC39-8M0055809 | 3V1-00011-0 | KIT SEGMENTOS         | PISTON RING KIT            |
| 18 | PAF8-05010004   | 3V1-02305-0 | JUNTA ESCAPE          | GASKET, EXHAUST COVER      |
| 19 | PAF8-05010005   | 346-01032-0 | JUNTA TERMOSTATO      | GASKET, THERMOSTAT COVER   |
| 20 | PAF8-05000024   | 98AB-5-0330 | TUBO                  | WATER PIPE                 |
| 21 | PAF8-05030001   | 3V1-07201-0 | VÁLVULA ADMISIÓN      | VALVE INTAKE               |
| 22 | PAF8-05030002   | 3V1-07202-0 | VÁLVULA ESCAPE        | VALVE EXHAUST              |
| 23 | PAF8-05030005   | 3AA-07203-0 | MUELLE VÁLVULA        | SPRING VALVE               |
| 24 | PAF8-05030006   | 3V1-07221-0 | RETEN RESORTE         | RETAINER, VALVE SPRINGER   |
| 25 | PAF8-05030007   | 3H6-07223-0 | SEGURO DE VÁLVULA     | CLAMP, VALVE               |
| 26 | PAF15-07040304  | 3H8-07237-0 | TUERCA                | LOCK NUT                   |
| 27 | PAF15-07040303  | 3R0-07238-0 | TORNILLO AJUSTE       | SCREW, VALVE ADJUSTING     |
| 28 | PAF8-05030200   | 3V1-07235-0 | BALANCÍN              | ROCKER                     |
| 29 | PAF8-05030009   | 3AA-07225-0 | MUELLE                | SPRING ROCKER              |
| 30 | PAF8-05030015   | 3R3-07227-0 | ARANDELA              | BUSHER, ROCKER SPRING      |
| 31 | PAF8-05030010   | 3H8-07226-0 | EJE                   | SHAFT ROCKER               |
| 32 | PAF8-05030012   | 3V1-07653-0 | JUNTA BOMBA ACEITE    | OIL PUMP GASKET            |
| 33 | PAF8-05030300   | 3V1-07600-0 | BOMBA ACEITE          | OIL PUMP                   |
| 34 | PAF8-05000100   | 3V1-02305-0 | JUNTA CULATA          | CYLINDER HEAD GASKET       |
| 35 | PAF8-05030100   | 3V1B01001-0 | CULATA                | CYLINDER HEAD ASSY         |
| 36 | PAF8-05000002   | 3V1-01024-0 | JUNTA TAPA CULATA     | CYLINDER HEAD COVER GASKET |
| 37 | PAF8-05030008   | 3V1-07010-0 | ÁRBOL DE LEVAS        | CRAMSHAFT                  |
| 38 | PAT3.6-04000006 | 309-00131-0 | CHAVETA               | KEY                        |
| 39 | PAF8-05030011   | 3H8-07025-0 | RETÉN ACEITE          | OIL SEAL 18x35x7.8 mm      |
| 40 | PAF8-05030400   | 3H8-10062-2 | POLEA                 | DRIVER PULLEY              |
| 41 | PAF8-05000004   | 3V1-10045-0 | CORREA                | TIMING BELT                |
| 42 | PAF8-05010016   | 3V1-10068-0 | TUERCA                | NUT                        |
| 43 | PAF8-05010015   | 3V1-10063-0 | ARANDELA              | BELT GUIDER                |
| 44 | PAF8-05010014   | 3V1-10060-0 | POLEA                 | DRIVER PULLEY              |
| 45 | PAF8-05000009   | 3V1-02104-0 | JUNTA COLECTOR        | GASKET MANIFOLD            |
| 46 | PAF8-05000008   | 3V1-02010-1 | COLECTOR ADMISIÓN     | INTAKE MANIFOLD            |
| 47 | PAF15-07000017  | 3V1-02011-0 | JUNTA CARBURADOR      | GASKET CARBURETOR          |
| 48 | PAF15-07000018  | 3V1-03952-0 | SEPARADOR, CARBURADOR | INSULATOR, CARBURETOR      |

# JUNTAS DE MOTOR 4 TIEMPOS

# ENGINE GASKET 4 STROKES

## JUNTAS DE CULATA

| REF            | OEM         |  |
|----------------|-------------|-----------------------------------------------------------------------------------|
| REC309-01005-2 | 309-01005-2 | M2.5<br>M2.5A<br>M2.5A2<br>M3.5A<br>M3.5A2                                        |



| REF            | OEM         |  |
|----------------|-------------|-----------------------------------------------------------------------------------|
| REC3B2-01005-0 | 3B2-01005-0 | M6B<br>M8B<br>M9.8B                                                               |





| REF            | OEM         |  |
|----------------|-------------|-----------------------------------------------------------------------------------|
| REC351-01005-0 | 351-01005-0 | M9.9D<br>M15D<br>M9.9D2<br>M15D2                                                  |





## CYLINDER HEAD GASKET

| REF            | OEM         |  |
|----------------|-------------|-------------------------------------------------------------------------------------|
| REC350-01005-0 | 350-01005-0 | M18E2                                                                               |



| REF            | OEM         |  |
|----------------|-------------|-------------------------------------------------------------------------------------|
| REC346-01005-0 | 346-01005-0 | M25C3<br>M30A4                                                                      |



| REF            | OEM         |  |
|----------------|-------------|-------------------------------------------------------------------------------------|
| REC3C8-01005-4 | 3C8-01005-4 | M40D2<br>M50D2                                                                      |



## JUNTAS BASE DE MOTOR

## CYLINDER GASKET

| REF            | OEM         |  |
|----------------|-------------|-------------------------------------------------------------------------------------|
| REC350-01303-0 | 350-01303-0 | M9.9D2<br>M15D2<br>M18E2                                                            |

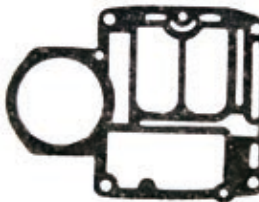

| REF            | OEM         |  |
|----------------|-------------|---------------------------------------------------------------------------------------|
| REC346-01303-0 | 350-01303-0 | M25C3<br>M30A4                                                                        |

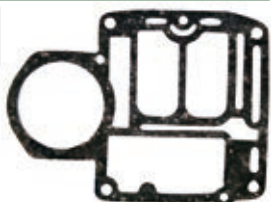

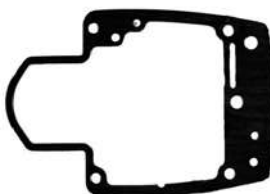

| REF            | OEM         |  |
|----------------|-------------|-------------------------------------------------------------------------------------|
| REC350-61012-1 | 350-61012-1 | M9.9D2<br>M15D2<br>M18E2                                                            |





| REF            | OEM         |  |
|----------------|-------------|---------------------------------------------------------------------------------------|
| REC3C8-01303-4 | 3C8-01303-4 | MD40B<br>MD50B                                                                        |



| REF            | OEM         |  |
|----------------|-------------|-------------------------------------------------------------------------------------|
| REC3B2-01303-0 | 3B2-01303-0 | M6B<br>M8B<br>M9.8B                                                                 |



| REF            | OEM         |  |
|----------------|-------------|---------------------------------------------------------------------------------------|
| REC3F3-01303-1 | 3F3-01303-1 | M60C<br>M70C                                                                          |









# PISTONES

# PISTONS

## KITS DE PISTONES





## PISTON KITS

|                                                                                   | STD             |             |                         |
|-----------------------------------------------------------------------------------|-----------------|-------------|-------------------------|
|                                                                                   | REF             | OEM         |                         |
|  | REC779-803677   | 350-00001-0 | M9.9D2<br>M15D2 (2 Cyl) |
|  | REC8M0080357    | 351-00011-0 |                         |
|  | REC629-803674   | 350-00040-0 |                         |
|  | REC41-825713002 | 332-00021-0 |                         |
|  | REC53-16057     | 350-00024-1 |                         |
|  | REC31-16052     | 350-00042-0 |                         |









|                                                                                   | STD          |             |                            |
|-----------------------------------------------------------------------------------|--------------|-------------|----------------------------|
|                                                                                   | REF          | OEM         |                            |
|  | REC779-9615T | 369-00001-0 | M4C<br>M5B<br>M5BS (1 Cyl) |
|  | REC8M0080357 | 351-00011-0 |                            |
|  | REC41-16056  | 369-00021-0 |                            |
|  | REC53-16057  | 350-00024-1 |                            |
|  | REC31-16052  | 350-00042-0 |                            |









|                                                                                     | STD              |             |               |
|-------------------------------------------------------------------------------------|------------------|-------------|---------------|
|                                                                                     | REF              | OEM         |               |
|   | REC779-803677T02 | 351-00001-1 | M18E2 (2 Cyl) |
|  | REC629-803674    | 350-00040-0 |               |
|  | REC41-803680002  | 350-00021-0 |               |
|  | REC53-16057      | 350-00024-1 |               |
|  | REC31-16052      | 350-00042-0 |               |









|                                                                                     | STD            |             |                             |
|-------------------------------------------------------------------------------------|----------------|-------------|-----------------------------|
|                                                                                     | REF            | OEM         |                             |
|  | REC779-804886  | 3B2-00001-0 | M6B<br>M8B<br>M9.8B (2 Cyl) |
|  | REC39-803678A3 | 3B2-00011-0 |                             |
|  | REC629-8036741 | 3B2-00040-0 |                             |
|  | REC41-8036801  | 3B2-00021-0 |                             |
|  | REC53-16057    | 350-00024-1 |                             |
|  | REC31-8036752  | 338-00042-0 |                             |







|                                                                                     | STD              |             |                        |
|-------------------------------------------------------------------------------------|------------------|-------------|------------------------|
|                                                                                     | REF              | OEM         |                        |
|  | REC779-879194T01 | 346-00001-1 | M25C3<br>M30A4 (2 Cyl) |
|  | REC39-16054A5    | 346-00011-0 |                        |
|  | REC629-813047T01 | 336-00040-1 |                        |
|  | REC41-803680003  | 3C8-00021-0 |                        |
|  | REC53-16057      | 350-00024-1 |                        |
|  | REC345-00042-0   | 345-00042-0 |                        |



TOHATSU

|                                                                                   | STD             |                            |  |
|-----------------------------------------------------------------------------------|-----------------|----------------------------|-----------------------------------------------------------------------------------|
|                                                                                   | REF             | OEM                        |                                                                                   |
|  | REC779-96152    | 3C8-00001-3                | M40D2<br>M50D2 (3 Cyl)                                                            |
|  | REC8M0080349    | 356-00011-0<br>346-00011-0 |                                                                                   |
|  | REC629-8036741  | 3B2-00040-0                |                                                                                   |
|  | REC41-803680003 | 3C8-00021-0                |                                                                                   |
|  | REC53-16057     | 334-00024-1                |                                                                                   |
|  | REC345-00042-0  | 345-00042-0                |                                                                                   |



|                                                                                   | STD            |             |  |
|-----------------------------------------------------------------------------------|----------------|-------------|-----------------------------------------------------------------------------------|
|                                                                                   | REF            | OEM         |                                                                                   |
|  | PAF8-05020101  | 3V1-00001-0 | MFS8<br>MFS9.8A-A2-A3<br>(2 Cyl)                                                  |
|  | PAF8-05020200  | 3V1-00040-0 |                                                                                   |
|  | PAF8-05020105  | 332-00024-0 |                                                                                   |
|  | PAF15-07020005 | 350-00024-1 |                                                                                   |



KITS AROS DE PISTONES

RING KITS

| REF            | OEM         |  |
|----------------|-------------|-----------------------------------------------------------------------------------|
| REC3F3-00011-2 | 3F3-00011-2 | 60 / 70 HP                                                                        |



CIGÜEÑAL

CRANKSHAFT

RODAMIENTOS DE CIGÜEÑAL

CRANKSHAFT BEARINGS

| REF             | OEM         |                  |  |
|-----------------|-------------|------------------|-------------------------------------------------------------------------------------|
| REC30-898101936 | 9643-3-6004 | SUPERIOR   UPPER | M2.5A                                                                               |
| REC30-95307     | 9643-3-6202 | INFERIOR   UNDER | M3.5A-B                                                                             |



RETENES DE ACEITE

OIL SEALS

| REF           | OEM         | (mm)          |  |
|---------------|-------------|---------------|-------------------------------------------------------------------------------------|
| REC26-8537072 | 346-01215-0 | 18 x 28 x 6   | M25C3                                                                               |
|               |             |               | M30A4                                                                               |
|               |             |               | MFS25A-B<br>MFS30A-B<br>MFS40A<br>MFS50A<br>M15D2<br>M18E2                          |
| REC26-161622  | 346-65013-0 | 17 x 30 x 9   | M25C3                                                                               |
|               |             |               | M30A4                                                                               |
|               |             |               | M9.9D2                                                                              |
|               |             |               | MFS20C                                                                              |
|               |             |               | MFS18B2                                                                             |
|               |             |               | MFS15C-B2                                                                           |
|               |             |               | MFS30B-A                                                                            |
|               |             |               | MFS25A-B                                                                            |
|               |             |               | MFS20C                                                                              |
|               |             |               | MFS9.9B2-C                                                                          |
| REC8M0065585  | 350-01215-5 | 25 x 69 x 9,5 | M9.9D2                                                                              |
|               |             |               | M15D2                                                                               |
|               |             |               | M18E2                                                                               |

| REF          | OEM         | (mm)        |  |
|--------------|-------------|-------------|---------------------------------------------------------------------------------------|
| REC26-16162  | 369-60223-0 | 10 x 24 x 8 | M4C                                                                                   |
|              |             |             | M5B                                                                                   |
|              |             |             | M5BS<br>MFS4A-B<br>/ 5A-B-C /<br>6A-B-C                                               |
| REC26-161301 | 346-60111-0 | 18 x 28 x 8 | M25C3                                                                                 |
|              |             |             | M30A4                                                                                 |
|              |             |             | MFS30A - B                                                                            |
|              |             |             | MFS25A - B                                                                            |
| REC26-803667 | 350-00121-0 | 25 x 45 x 8 | M9.9D2                                                                                |
|              |             |             | M15D2                                                                                 |
|              |             |             | M18E2                                                                                 |
|              |             |             | M4C                                                                                   |
| REC26-16703  | 369-01215-0 | 10 x 62 x 7 | M5B                                                                                   |
|              |             |             | M5BS                                                                                  |
|              |             |             | MFS4A-B<br>/ 5A-B-C /<br>6A-B-C                                                       |
|              |             |             | M4C                                                                                   |
|              |             |             | M5B                                                                                   |

# SISTEMA DE ESCAPE Y ADMISION

# EXHAUST AND INTAKE SYSTEM

## SISTEMA DE ESCAPE

## EXHAUST SYSTEM

### JUNTAS DE ESCAPE

### GASKET, EXHAUST

| REF            | OEM         |  |
|----------------|-------------|-----------------------------------------------------------------------------------|
| REC3C8-02305-0 | 3C8-02305-0 | M40D2 / B<br>M50D2 / B                                                            |



# UNIDADES DE TRANSMISIÓN

# UNIT DRIVES & COMPONENTS

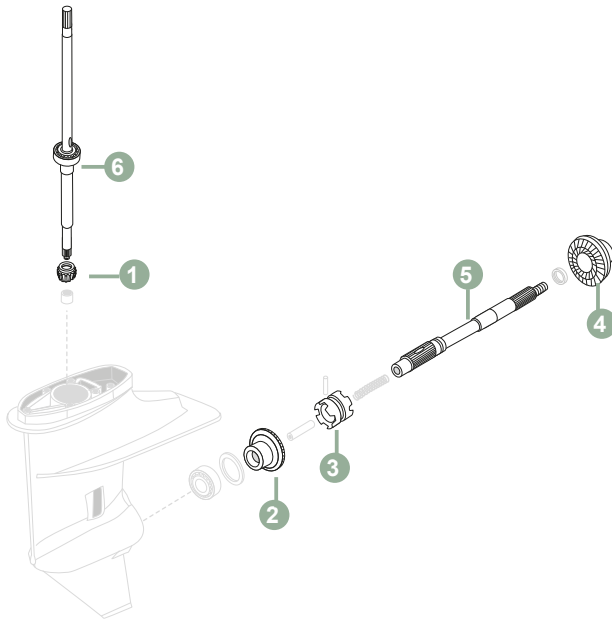

## GUÍA PIEZAS COLA

## STERN DRIVE COMPONENTS GUIDE

|  | 1               | 2               | 3             | 4               | 5             | 6 S            | 6 L            |
|-------------------------------------------------------------------------------------|-----------------|-----------------|---------------|-----------------|---------------|----------------|----------------|
| M2.5A, B, A2                                                                        | REC43-16138     | REC43-812944    |               |                 |               |                |                |
| M3.5A, B, A2, B2                                                                    | REC43-16138     | REC43-812944    |               |                 |               |                |                |
| M4C<br>M5B, BS                                                                      | REC43-16138     | REC43-812944    |               | REC43-8129451   | REC44-195133  | REC45-161351   | REC8M0076368   |
| MFS4, 5, 6A2, B, C                                                                  | REC43-16138     | REC43-812944    |               | REC43-8129451   | REC44-195133  | REC45-161351   | REC8M0076368   |
| MFS8, 9.8B                                                                          | PAF8-04000003   | PAF8-04010000   |               | PAF8-04000014   | PAF8-04000301 |                |                |
| MFS8A2-3<br>MFS9.8A2-3<br>M9.9                                                      | PAF8-04000003   | PAF8-04010000   | PAF8-04000303 | PAF8-04000014   | PAF8-04000301 | PAF8-04020001S | PAF8-04020001L |
| M15D2<br>M18E2<br>MFS9.9B2                                                          | REC43-803740    | REC43-803739    |               | REC43-803741    | REC879147T96  | REC45-803738   | REC45-8037381  |
| MFS15B2<br>MFS18B2                                                                  | REC43-803740T02 | REC43-803739T03 |               | REC43-803741T03 | REC879147T96  |                |                |

4T MFS8 • MFS9.8  
STROKES

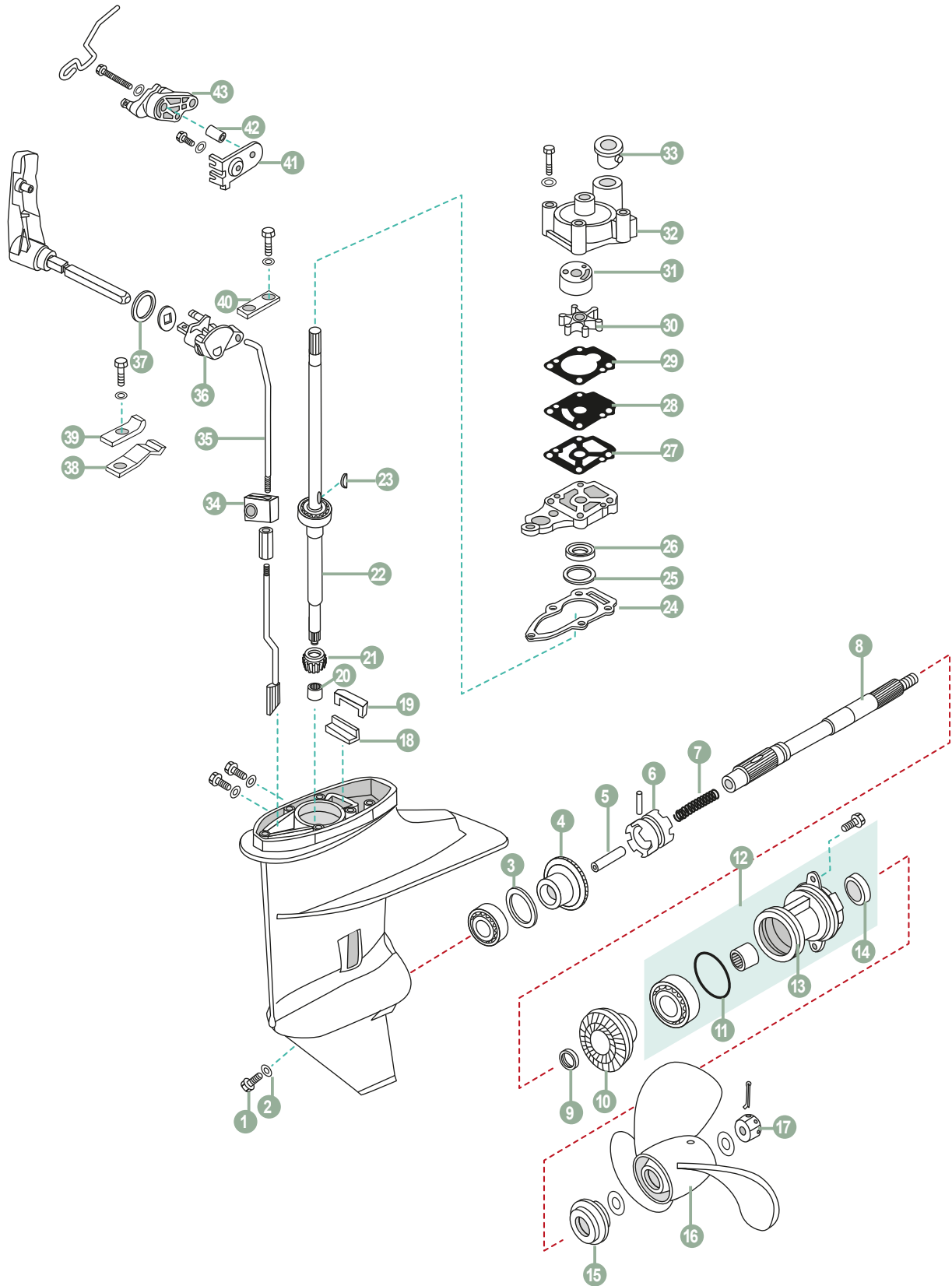

TOHATSU

|    | REF             | OEM         |                    |                             |
|----|-----------------|-------------|--------------------|-----------------------------|
| 1  | REC90340-08002  | 332-60005-2 | TAPÓN DRENAJE      | PLUG, OIL HOSE              |
| 2  | REC90430-08020  | 332-60006-0 | JUNTA              | GASKET                      |
| 3  | PAF8-04000012-1 | 369-64014-0 | GRUESO 0.10mm      | SHIM 0.10mm                 |
|    | PAF8-04000012-2 | 369-64015-0 | GRUESO 0.15mm      | SHIM 0.15mm                 |
| 4  | PAF8-04010000   | 3B2-64010-0 | PIÑÓN ADELANTE     | GEARM FORWARD               |
| 5  | PAF8-04000305   | 369-64223-0 | PIN                | PIN CLUTCH                  |
| 6  | PAF8-04000303   | 3B2-64215-0 | SELECTOR           | CLUTCH, DOG                 |
| 7  | PAF8-04000302   | 3V1-64221-0 | MUELLE             | SPRING, CLUTCH              |
| 8  | PAF8-04000301   | 3V1-64211-0 | EJE HÉLICE         | SHAFT, PROPELLER            |
| 9  | PAF8-04000012   | 369-64032-0 | ARANDELA           | WASHER                      |
| 10 | PAF8-04000014   | 3B2-64030-0 | PIÑÓN ATRÁS        | GEAR REVERSE                |
| 11 | PAF8-04040002   | 345-65015-0 | TÓRICA             | O-RING                      |
| 12 | PAF8-04040000   | 3B2S60100-0 | DIÁBOLO            | COVER ASSY                  |
| 13 | PAF8-04040001   | 3B2S60101-0 | DIÁBOLO            | COVER, LOWE CASING          |
| 14 | PAF8-04040004   | 369-60111-0 | RETÉN              | OIL SEAL                    |
| 15 | PAF8-04000019   | 3B2-64230-1 | GRUESO             | CUSHION, PROPELLER          |
| 16 | PAF8-04050000   | 3B2W64517-0 | HÉLICE             | PROPELLER ASSY              |
| 17 | PAF15-06000016  | 369-64121-0 | TUERCA             | NUT, HEXAGON                |
| 18 | PAF8-04000015   | 3V1-60042-0 | GUÍA SELLO DE GOMA | GUIDE RUBBER SEAL           |
| 19 | PAF8-04000016   | 3V1-60041-0 | SELLO DE GOMA      | WATER ENVELOP               |
| 20 | PANSKFJ-1516    | 3V1-60211-0 | RODAMIENTO         | BEARING                     |
| 21 | PAF8-04000003   | 3B2-64020-0 | PIÑÓN DE ATAQUE    | INITIATIVE GEAR             |
| 22 | PAF8-04020001L  | 3V1-64307-1 | EJE VERTICAL L     | DRIVE SHAFT L               |
|    | PAF8-04020001S  | 3V1-64306-1 | EJE VERTICAL S     | DRIVE SHAFT S               |
| 23 | PAF8-04000021   | 3B2-65022-0 | PIN                | PIN, DOWER                  |
| 24 | PAF8-04000005   | 3B2-65020-0 | JUNTA              | GASKET, WATER PUMP SEAT     |
| 25 | PAF8-04000004-1 | 3B2-64023-0 | GRUESO 0.10 mm     | SHIM 0.10mm                 |
| 26 | PAF8-04000101   | 309-60111-0 | RETÉN              | OIL SEAL                    |
| 27 | PAF8-04000006   | 3B2-65029-0 | JUNTA              | GASKET, OUTER PLATE         |
| 28 | PAF8-04000007   | 3B2-65025-0 | PLACA              | OUTER PLATE                 |
| 29 | PAF8-04000008   | 3B2-65018-0 | JUNTA              | GASKET, OUTER PLATE         |
| 30 | PAF8-04000200   | 3B2-65021-1 | IMPULSOR           | IMPELLER                    |
| 31 | PAF8-04000010   | 3B2-65011-0 | CASQUILLO          | INNER SHELL, WATER PUMP     |
| 32 | PAF8-04000009   | 3B2-65016-0 | BOMBA DE AGUA      | WATER PUMP                  |
| 33 | PAF8-04000013   | 3B2-65016-0 | RETÉN              | SEAL                        |
| 34 | PAF8-03000011   | 3V1-66302-0 | SEGURO             | LOCK BLOCK                  |
| 35 | PAF8-03000010   | 3V1-66211-0 | EJE DEL CAMBIO     | SHIFT ROD                   |
| 36 | PAF8-03010003   | 3V1-66225-0 | SEGURO DEL EJE     | BLOCK SHIFT ROD             |
| 37 | PAF8-03010001   | 3V1-66187-0 | ARANDELA           | WASHER, HANDLE              |
| 38 | PAF8-03010005   | 3B2-66113-0 | TOPE               | STOPPER, SHIFT LEVER        |
| 39 | PAF8-03010006   | 3C8-66116-0 | PLACA              | PLATE, SHIFTLIVER STOPPER   |
| 40 | PAF8-03010007   | 3B1-66145-0 | PLACA              | PLATE                       |
| 41 | PAF8-05000020   | 3V1-63508-0 | PLACA              | PALTE                       |
| 42 | PAF8-05000018   | 346-67114-0 | CASQUILLO          | PLATE ACCELEROGRAPH ENFOPCE |
| 43 | PAF8-05000019   | 3V1-63622-0 | POLEA              | MAIN PULLEY                 |

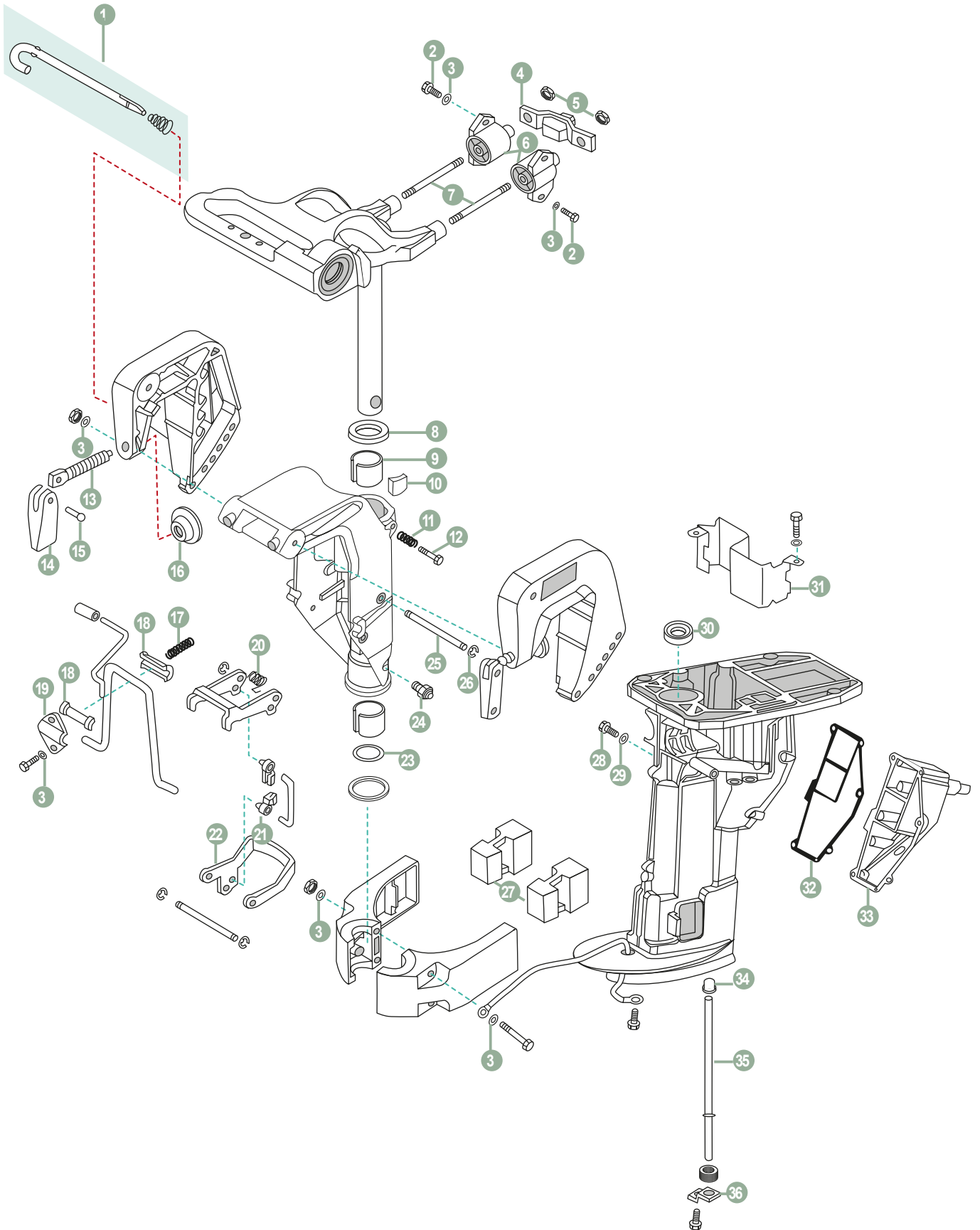

|    | REF              | OEM                        |                      |                             |
|----|------------------|----------------------------|----------------------|-----------------------------|
| 1  | PAF8-01010200    | 350-62121-1<br>369-62122-2 | GANCHO DE CIERRE     | THRUST ROD ASSY             |
| 2  | PAGB/T5783-M6X20 | 910184-5620                | TORNILLO             | BOLT M6x20                  |
| 3  | PAGB/T96-6       | 910184-5620                | ARANDELA             | WASHER                      |
| 4  | PAF8-00000100    | 3V1-61333-1                | SILENBLOCK           | ABSORBER (FRONT)            |
| 5  | PAGB/T889.1-M8   | 3V1-61324-0                | TUERCA M8            | NUT M8                      |
| 6  | PAF8-02000100    | 3V1-61301-1<br>940113-0800 | SILENBLOCK           | ABSORBER ASSY               |
| 7  | PAF8-01000003    | 3V1-61313-0                | TORNILLO M8x65       | DICEPHALOUS BOLT M8x65      |
| 8  | PAF8-01000001    | 350-62423-0                | ARANDELA             | WASHER, ROTARY BRACKET      |
| 9  | PAF8-01000002    | 350-62417-0                | CASQUILLO            | BUSHING                     |
| 10 | PAF8-01000100    | 345-62441-0                | SEGURO DE CIERRE     | LOCKING BLOCK ASSY          |
| 11 | PAF8-01010102    | 346-62421-1                | MUELLE               | SPRING, LOCKING             |
| 12 | PAGB/T5783-M8X30 | 910113-0830                | TORNILLO M8X30       | BOLT M8x30                  |
| 13 | PAF4-01010002    | 398-62103-0                | TORNILLO             | CLAMP SCREW                 |
| 14 | REC6L8-G3118-01  | 332562102-1                | MANETA               | CLAMP HANDLE, STERN         |
| 15 | PAF4-01010005    | 3C8-62104-1                | RIBETE               | RIVET, CLAMP HANDLE         |
| 16 | PAF4-01010003    | 332-62101-0                | ARANDELA             | CLAMP PAD                   |
| 17 | PAF8-01010104    | 369-66112-1                | MUELLE               | SPRING, SUPPORT             |
| 18 | PAF8-01010103    | 393-62437-0                | PASADOR              | PIN                         |
| 19 | PAF8-01010105    | 369-62439-1                | PLACA                | PRESS PLATE                 |
| 20 | PAF8-01010109    | 3B2-66315-0                | MUELLE               | SPRING, WREST               |
| 21 | PAF8-01010112    | 3K9-05223-0                | ADAPTADOR            | TIE-IN, CONNECTING ROD      |
| 22 | PAF8-01010106    | 3V1-66313-0                | UÑA                  | OUTER FRAME, ROTARY BRACKET |
| 23 | PAJASOF40435-022 | 350-62415-0                | RETÉN                | O-RING Ø22.4xø3.5           |
| 24 | PAGB/T7940.1-M6  | 344-67177-0                | ENGRASADOR M6        | OILER M6                    |
| 25 | PAF8-01010108    | 3B2-66321-1                | EJE                  | SHAFT, ROTARY BRACKET       |
| 26 | PAGB/T896-5      | 945303-0500                | CLIP                 | CIRCLIP                     |
| 27 | PAF8-00000002    | 3V1-61302-0                | AMORTIGUADOR         | ABSORBER                    |
| 28 | PAF15-04000002   | 3R3-07405-1                | TAPÓN                | BOLT, OIL DRAIN             |
| 29 | PAF15-04000003   | 3R3-07406-0                | JUNTA                | GASKET                      |
| 30 | PAF8-02000002    | 3B2-01215-0                | RETÉN                | OIL SEAL                    |
| 31 | PAF8-02000003    | 3V1-07440-0                | SEPARADOR CARTER     | CLAPBOARD, OIL SUMP         |
| 32 | PAF8-02000004    | 3V1-61220-0                | JUNTA TAPA DE ESCAPE | GASKET, EXHAUST OUTER COVER |
| 33 | PAF8-02000005    | 3V1-61208-0                | TAPA ESCAPE          | EXHAUST OUTER COVER         |
| 34 | PAF8-02000007    | 3V1-65206-0                | RETÉN TUBO DE AGUA   | UPPER SEAL, WATER PIPE      |
| 35 | PAF8-02000006(L) | 3V1-65110-0                | TUBO L               | WATER PIPE L                |
|    | PAF8-02000006(S) | 3V1-65100-0                | TUBO S               | WATER PIPE S                |
| 36 | PAF8-02000009    | 3V1-65203-0                | PLACA TUBO DE AGUA   | PLATE, WATER PIPE           |

| OEM           | REF              |                 | OEM          | REF              |             | OEM          | REF              |             |
|---------------|------------------|-----------------|--------------|------------------|-------------|--------------|------------------|-------------|
| 40135         | REC40135         | 644             | 351-00001-1  | REC779-803677T02 | 655-661     | 3B2-01303-0  | REC3B2-01303-0   | 660         |
| 40145         | REC40145         | 644             | 351-00011-0  | REC8M0080357     | 654-655-661 | 3B2-63600-1  | REC804898        | 651         |
| 40155         | REC40155         | 644             | 351-01005-0  | REC351-01005-0   | 660         | 3B2-64010-0  | PAF8-04010000    | 665         |
| 40165         | REC40165         | 644             | 353-76010-4  | REC353-76010-4M  | 648         | 3B2-64020-0  | PAF8-04000003    | 665         |
| 353760203     | REC353760203     | 649             | 356-00011-0  | REC8M0080349     | 662         | 3B2-64023-0  | PAF8-04000004-1  | 665         |
| 101-00121-0   | REC26-803514     | 654             | 356-00043-0  | REC31-8130482    | 655         | 3B2-64030-0  | PAF8-04000014    | 665         |
| 172-36008-0   | PAF8-05000003    | 657             | 366-02230-0  | PAF4-05000300    | 644         | 3B2-64215-0  | PAF8-04000303    | 665         |
| 309-00131-0   | PAT3.6-04000006  | 659             | 369-00001-0  | REC779-9615T     | 654-661     | 3B2-64230-1  | PAF8-04000019    | 665         |
| 309-01005-2   | REC309-01005-2   | 660             | 369-00021-0  | REC41-16056      | 654-661     | 3B2-65011-0  | PAF8-04000010    | 653-665     |
| 309-60111-0   | PAF8-04000101    | 665             | 369-00043-0  | REC31-813048     | 654         | 3B2-65016-0  | PAF8-04000009    | 665         |
| 332-00021-0   | PAF8-05020105    | 659             | 369-00061-0  | REC813046002     | 654         | 3B2-65016-0  | PAF8-04000013    | 665         |
| 332-00021-0   | REC41-825713002  | 655-661         | 369-00122-0  | REC26-16051      | 654         | 3B2-65018-0  | PAF8-04000008    | 665         |
| 332-00024-0   | PAF8-05020105    | 662             | 369-00132-0  | PAF8-05000024    | 657         | 3B2-65020-0  | PAF8-04000005    | 665         |
| 332-60005-2   | REC90340-08002   | 665             | 369-01215-0  | REC26-16703      | 662         | 3B2-65021-1  | PAF8-04000200    | 665         |
| 332-60006-0   | REC90430-08020   | 665             | 369-03231-0  | REC16253         | 646         | 3B2-65021-1  | REC3B2-65021-1   | 652         |
| 332-62101-0   | PAF4-01010003    | 667             | 369-03302-0  | REC271-16274     | 644         | 3B2-65022-0  | PAF8-04000021    | 665         |
| 332S62102-1   | REC6L8-G3118-01  | 667             | 369-03303-0  | REC16275         | 644         | 3B2-65025-0  | PAF8-04000007    | 653-665     |
| 334-00024-1   | REC53-16057      | 655-656-662     | 369-03306-0  | REC16325         | 644         | 3B2-65029-0  | PAF8-04000006    | 665         |
| 334-00061-0   | REC8130461       | 655             | 369-03307-0  | REC27-16326      | 644         | 3B2-66113-0  | PAF8-03010005    | 665         |
| 336-00040-1   | REC629-813047T01 | 655-661         | 369-06021-0  | REC369-06021-0   | 647         | 3B2-66315-0  | PAF8-01010109    | 667         |
| 338-00042-0   | REC31-8036752    | 654-661         | 369-0682-0   | REC369-0682-0    | 649         | 3B2-66321-1  | PAF8-01010108    | 667         |
| 344-67177-0   | PAGB/T7940.1-M6  | 667             | 369-60111-0  | PAF8-04040004    | 665         | 3B2-87122-0  | REC6G1-W0093-00  | 645         |
| 345-00042-0   | REC345-00042-0   | 655-656-661-662 | 369-60223-0  | REC26-16162      | 662         | 3B2S60100-0  | PAF8-04040000    | 665         |
| 345-00113-0   | REC30-16049T01   | 655             | 369-62122-2  | PAF8-01010200    | 667         | 3B2S60101-0  | PAF8-04040001    | 665         |
| 345-62441-0   | PAF8-01000100    | 667             | 369-62439-1  | PAF8-01010105    | 667         | 3B2W64517-0  | PAF8-04050000    | 665         |
| 345-65015-0   | PAF8-04040002    | 665             | 369-64014-0  | PAF8-04000012-1  | 665         | 3B7-02230-0  | PAF15-07080000   | 644         |
| 345-65021-0   | REC345-65021-0   | 652             | 369-64015-0  | PAF8-04000012-2  | 665         | 3B7-60217-0  | REC3B7-60217-0AL | 652         |
| 346-00001-1   | REC779-879194T01 | 655-661         | 369-64032-0  | PAF8-04000012    | 665         | 3B7-60217-0M | REC3B7-60217-0   | 652         |
| 346-00011-0   | REC39-16054A5    | 655-661         | 369-64121-0  | PAF15-06000016   | 665         | 3B7-65021-2  | REC3B7-65021-2   | 652         |
| 346-00011-0   | REC8M0080349     | 656-662         | 369-64223-0  | PAF8-04000305    | 665         | 3C8-00001-3  | REC779-96152     | 662         |
| 346-01005-0   | REC346-01005-0   | 660             | 369-65011-0  | REC16157         | 653         | 3C8-00001-3  | REC779-9615T     | 656         |
| 346-01032-0   | PAF8-05010005    | 659             | 369-65025-0  | REC16159         | 653         | 3C8-00021-0  | REC41-16056      | 656         |
| 346-01215-0   | REC26-8537072    | 662             | 369-66112-1  | PAF8-01010104    | 667         | 3C8-00021-0  | REC41-803680003  | 655-661-662 |
| 346-02230-0   | PAF4-05000300    | 644             | 369-84398-0  | PAF8-05000025    | 659         | 3C8-00113-0  | REC31-855553     | 656         |
| 346-60111-0   | REC26-161301     | 662             | 369-87122-1  | REC6G1-W0093-00  | 645         | 3C8-01005-4  | REC3C8-01005-4   | 660         |
| 346-62421-1   | PAF8-01010102    | 667             | 389-83880-1  | REC389-83880-1   | 651         | 3C8-01303-4  | REC3C8-01303-4   | 660         |
| 346-65013-0   | REC26-161622     | 662             | 393-62437-0  | PAF8-01010103    | 667         | 3C8-02305-0  | REC3C8-02305-0   | 663         |
| 346-67114-0   | PAF8-05000018    | 665             | 398-62103-0  | PAF4-01010002    | 667         | 3C8-03125-0  | REC162532        | 646         |
| 346-76010-0   | REC346-76010-0M  | 648             | 3A0-06040-1  | REC3A0-06040-1   | 647         | 3C8-04028-0  | REC27-8555691    | 644         |
| 346-76010-0A0 | REC346-76010-0M  | 648             | 3A0-76079-0  | PAF8-05000006    | 657         | 3C8-62104-1  | PAF4-01010005    | 667         |
| 346-76010-0M  | REC346-76010-0M  | 648             | 3A3068300    | REC3A3068300     | 649         | 3C8-65021-2  | REC3C8-65021-2   | 652         |
| 346-87122-0   | REC6H3-W0093-02  | 645             | 3A3725600    | REC3A3725600     | 648         | 3C8-66116-0  | PAF8-03010006    | 665         |
| 350-00001-0   | REC779-803677    | 661             | 3AA-05004-0  | PAF8-05050004    | 657         | 3C8-76010-1  | REC50-8M0147039  | 648         |
| 350-00001-1   | REC779-803677    | 655             | 3AA-05013-0  | PAF8-05050018    | 657         | 3C8-87122-2  | REC6L2-W0093-00  | 646         |
| 350-00011-0   | REC39-803678A1   | 655             | 3AA-05019-0  | PAF4-04130101    | 657         | 3C8760101    | REC50-8M0147039  | 648         |
| 350-00021-0   | REC41-803680002  | 655-661         | 3AA-06021-0  | PAF8-05000300    | 647-657     | 3C8760101M   | REC50-8M0147039  | 648         |
| 350-00024-1   | PAF15-07020005   | 659-662         | 3AA-06060-0  | PAF8-05000400    | 657         | 3F0-65029-6  | REC3F0-65029-0   | 653         |
| 350-00024-1   | REC53-16057      | 654-655-661     | 3AA-06060-00 | PAF8-05000400    | 649         | 3F3-00011-2  | REC3F3-00011-2   | 662         |
| 350-00040-0   | REC629-803674    | 655-661         | 3AA-06091-0  | PAF8-05000600    | 657         | 3F3-01303-1  | REC3F3-01303-1   | 660         |
| 350-00042-0   | REC31-16052      | 654-655-661     | 3AA-07203-0  | PAF8-05030005    | 659         | 3F3-87122-1  | REC6H4-W0093-03  | 645         |
| 350-00061-0   | REC803673        | 655             | 3AA-07225-0  | PAF8-05030009    | 659         | 3FS-03100-0  | PAF8-05040000    | 645         |
| 350-00121-0   | REC26-803667     | 662             | 3AA060600M   | PAF8-05000400    | 649         | 3G2-06040-2  | REC3G2-06040-2   | 647         |
| 350-01005-0   | REC350-01005-0   | 660             | 3AC-02230-0  | PAF15-07080000   | 644         | 3G2-06060-2  | REC3G2-06060-2   | 649         |
| 350-01215-5   | REC8M0065585     | 662             | 3ACQ843301   | REC3ACQ843301    | 650         | 3G2-87122-2  | REC6L2-W0093-00  | 646         |
| 350-01303-0   | REC346-01303-0   | 660             | 3AD-02230-0  | PAF15-07080000   | 644         | 3G3-06021-1  | REC3G3-06021-1   | 647         |
| 350-01303-0   | REC350-01303-0   | 660             | 3B1-66145-0  | PAF8-03010007    | 665         | 3GFQ845001   | REC3GFQ845001    | 650         |
| 350-04005-0   | REC8537312       | 644             | 3B2-00001-0  | REC779-804886    | 654-661     | 3H6-07223-0  | PAF8-05030007    | 659         |
| 350-61012-1   | REC350-61012-1   | 660             | 3B2-00011-0  | REC39-803678A3   | 654         | 3H6-07611-0  | PAF15-07010100   | 646-657     |
| 350-62121-1   | PAF8-01010200    | 667             | 3B2-00011-0  | REC39-803678A3   | 661         | 3H6-07612-0  | PAF15-07010101   | 657         |
| 350-62415-0   | PAJASOF40435-022 | 667             | 3B2-00021-0  | REC41-8036801    | 654-661     | 3H8-02093-0  | PAF8-05010002    | 659         |
| 350-62417-0   | PAF8-01000002    | 667             | 3B2-00040-0  | REC629-8036741   | 654-661-662 | 3H8-07025-0  | PAF8-05030011    | 659         |
| 350-62423-0   | PAF8-01000001    | 667             | 3B2-00051-0  | REC26-85370711   | 654         | 3H8-07226-0  | PAF8-05030010    | 659         |
| 350-65011-1   | REC803751        | 653             | 3B2-01005-0  | REC3B2-01005-0   | 660         | 3H8-07237-0  | PAF15-07040304   | 659         |
|               |                  |                 | 3B2-01215-0  | PAF8-02000002    | 667         | 3H8-10062-2  | PAF8-05030400    | 659         |

| OEM          | REF              |         | OEM            | REF              |     |
|--------------|------------------|---------|----------------|------------------|-----|
| 3K9-05223-0  | PAF8-01010112    | 667     | 3V1-63508-0    | PAF8-05000020    | 665 |
| 3KY-76010-0  | REC3KY-76010-0   | 648     | 3V1-63622-0    | PAF8-05000019    | 665 |
| 3KY-76010-0M | REC3KY-76010-0   | 648     | 3V1-64211-0    | PAF8-04000301    | 665 |
| 3KY-76010-1  | REC3KY-76010-0   | 648     | 3V1-64221-0    | PAF8-04000302    | 665 |
| 3KY-76010-1M | REC3KY-76010-0   | 648     | 3V1-64306-1    | PAF8-04020001S   | 665 |
| 3M2-60218-0  | REC3M2-60218-0   | 652     | 3V1-64307-1    | PAF8-04020001L   | 665 |
| 3M2-60218-0  | REC3M2-60218-OAL | 652     | 3V1-65100-0    | PAF8-02000006(S) | 667 |
| 3R0-07238-0  | PAF15-07040303   | 659     | 3V1-65110-0    | PAF8-02000006(L) | 667 |
| 3R0-07615-0  | REC5GH-13440-00  | 645     | 3V1-65203-0    | PAF8-02000009    | 667 |
| 3R0-66308-0  | PAF8-05000021    | 657     | 3V1-65206-0    | PAF8-02000007    | 667 |
| 3R1-05003-1  | PAF8-05050006    | 657     | 3V1-66187-0    | PAF8-03010001    | 665 |
| 3R1-05007-0  | PAF8-05050009    | 657     | 3V1-66211-0    | PAF8-03000010    | 665 |
| 3R1-05012-0  | PAF8-05050007    | 657     | 3V1-66225-0    | PAF8-03010003    | 665 |
| 3R1-05125-0  | PAF8-05050003    | 657     | 3V1-66302-0    | PAF8-03000011    | 665 |
| 3R1-05131-0  | PAF4-04130100    | 657     | 3V1-66313-0    | PAF8-01010106    | 667 |
| 3R3-01030-0  | REC85676002      | 643-652 | 3V1-87122-0    | REC66M-W0093-01  | 645 |
| 3R3-07227-0  | PAF8-05030015    | 659     | 3V1060400      | PAF8-05000500    | 647 |
| 3R3-07405-1  | PAF15-04000002   | 667     | 3V1060400M     | PAF8-05000500    | 647 |
| 3R3-07406-0  | PAF15-04000003   | 667     | 3V1B01001-0    | PAF8-05030100    | 659 |
| 3R3-61017-0  | PAF8-00000003    | 659     | 3V1B01100-0    | PAF8-05010000    | 659 |
| 3R3R76150M   | REC5GH-13440-00  | 645     | 3V2-03100-2    | PAF8-05040000    | 645 |
| 3T5-06920-0  | PAF8-05000011    | 657     | 5GH-13440-00   | REC5GH-13440-00  | 645 |
| 3T5-10131-0  | PAF4-04000019    | 659     | 910113-0830    | PAGB/T5783-M8X30 | 667 |
| 3V1-00001-0  | PAF8-05020101    | 659-662 | 910184-5620    | PAGB/T5783-M6X20 | 667 |
| 3V1-00011-0  | REC39-8M0055809  | 659     | 910184-5620    | PAGB/T96-6       | 667 |
| 3V1-00030-1  | PAF8-05020001    | 659     | 940121-1200    | PAT15-04000011   | 657 |
| 3V1-00040-0  | PAF8-05020200    | 659-662 | 945303-0500    | PAGB/T896-5      | 667 |
| 3V1-00121-0  | PAF8-05010012    | 659     | 9603-3-6204    | REC30-16049      | 654 |
| 3V1-01024-0  | PAF8-05000002    | 659     | 9643-3-6004    | REC30-898101936  | 662 |
| 3V1-01303-0  | PAF8-00000004    | 659     | 9643-3-6202    | REC30-95307      | 662 |
| 3V1-02010-1  | PAF8-05000008    | 659     | 96603-3-6305   | REC30-160494     | 655 |
| 3V1-02011-0  | PAF15-07000017   | 659     | 98AB-5-0330    | PAF8-05000024    | 659 |
| 3V1-02104-0  | PAF8-05000009    | 659     | 98AH10-0120    | PAF8-05000017    | 659 |
| 3V1-02305-0  | PAF8-05000100    | 659     | EU3849900      | RECEU3849900     | 651 |
| 3V1-02305-0  | PAF8-05010004    | 659     | HPLM-15400-A0  | REC15400-RBA-F01 | 645 |
| 3V1-03952-0  | PAF15-07000018   | 659     | HPLM-15400-PE  | REC15400-RBA-F01 | 645 |
| 3V1-05104-1  | PAF8-05050005    | 657     | HPNB-37510-003 | REC37510-PNB-003 | 646 |
| 3V1-05259-0  | PAF8-05050002    | 657     | HZV4-30580-013 | REC30580-ZV4-013 | 647 |
| 3V1-06023-0  | PAF8-05090000W   | 647     | HZV5-19210-003 | REC19210-ZV5-003 | 652 |
| 3V1-06040-0  | PAF8-05000500    | 647-657 | HZV5-19300-043 | REC19300-ZV5-043 | 652 |
| 3V1-06071-0  | PAF8-05000200    | 647-657 | HZW1-19210-B04 | REC19210-ZW1-B02 | 652 |
| 3V1-06302-0  | PAF8-05000013    | 657     | HZW9-19300-003 | PAF15-07000031   | 652 |
| 3V1-06308-0  | PAF8-05000012    | 657     | HZY3-06192-000 | REC06192-ZY3-000 | 653 |
| 3V1-07010-0  | PAF8-05030008    | 659     | HZY3-16911-010 | REC16911-ZY3-010 | 644 |
| 3V1-07201-0  | PAF8-05030001    | 659     | HZY3-19210-003 | REC19210-ZY3-003 | 652 |
| 3V1-07202-0  | PAF8-05030002    | 659     | HZY3-31200-003 | REC31200-ZY3-003 | 648 |
| 3V1-07221-0  | PAF8-05030006    | 659     | HZY6-06192-000 | REC06192-ZY6-000 | 653 |
| 3V1-07235-0  | PAF8-05030200    | 659     | HZY6-31200-003 | REC31200-ZY6-003 | 648 |
| 3V1-07407-0  | PAF8-05010009    | 659     | HZY6-35668-003 | REC35668-ZY6-003 | 646 |
| 3V1-07410-0  | PAF8-05000800    | 659     | HZZ3-06240-R30 | REC06240-ZZ3-R30 | 650 |
| 3V1-07421-0  | PAF8-00000200    | 659     | HZZ3-06240-R40 | REC06240-ZZ3-R40 | 650 |
| 3V1-07440-0  | PAF8-02000003    | 667     | HZZ5-16911-003 | REC16911-ZZ5-003 | 644 |
| 3V1-07600-0  | PAF8-05030300    | 659     |                |                  |     |
| 3V1-07653-0  | PAF8-05030012    | 659     |                |                  |     |
| 3V1-10045-0  | PAF8-05000004    | 659     |                |                  |     |
| 3V1-10060-0  | PAF8-05010014    | 659     |                |                  |     |
| 3V1-10063-0  | PAF8-05010015    | 659     |                |                  |     |
| 3V1-10068-0  | PAF8-05010016    | 659     |                |                  |     |
| 3V1-60041-0  | PAF8-04000016    | 665     |                |                  |     |
| 3V1-60042-0  | PAF8-04000015    | 665     |                |                  |     |
| 3V1-60211-0  | PANSKFJ-1516     | 665     |                |                  |     |
| 3V1-61208-0  | PAF8-02000005    | 667     |                |                  |     |
| 3V1-61220-0  | PAF8-02000004    | 667     |                |                  |     |
| 3V1-61301-1  | PAF8-02000100    | 667     |                |                  |     |
| 940113-0800  |                  |         |                |                  |     |
| 3V1-61302-0  | PAF8-00000002    | 667     |                |                  |     |
| 3V1-61313-0  | PAF8-01000003    | 667     |                |                  |     |
| 3V1-61324-0  | PAGB/T889.1-M8   | 667     |                |                  |     |
| 3V1-61333-1  | PAF8-00000100    | 667     |                |                  |     |

| REF              | OEM                         | REF             | OEM                 | REF              | OEM                |
|------------------|-----------------------------|-----------------|---------------------|------------------|--------------------|
| PAF15-04000002   | 3R3-07405-1 667             | PAF8-04000010   | 3B2-65011-0 653-665 | PAF8-05030005    | 3AA-07203-0 659    |
| PAF15-04000003   | 3R3-07406-0 667             | PAF8-04000012   | 369-64032-0 665     | PAF8-05030006    | 3V1-07221-0 659    |
| PAF15-06000016   | 369-64121-0 665             | PAF8-04000012-1 | 369-64014-0 665     | PAF8-05030007    | 3H6-07223-0 659    |
| PAF15-07000017   | 3V1-02011-0 659             | PAF8-04000012-2 | 369-64015-0 665     | PAF8-05030008    | 3V1-07010-0 659    |
| PAF15-07000018   | 3V1-03952-0 659             | PAF8-04000013   | 3B2-65016-0 665     | PAF8-05030009    | 3AA-07225-0 659    |
| PAF15-07000031   | HZW9-19300-003 652          | PAF8-04000014   | 3B2-64030-0 663-665 | PAF8-05030011    | 3H8-07025-0 659    |
| PAF15-07010100   | 3H6-07611-0 646-657         | PAF8-04000015   | 3V1-60042-0 665     | PAF8-05030012    | 3V1-07653-0 659    |
| PAF15-07010101   | 3H6-07612-0 657             | PAF8-04000016   | 3V1-60041-0 665     | PAF8-05030015    | 3R3-07227-0 659    |
| PAF15-07020005   | 350-00024-1 659-662         | PAF8-04000019   | 3B2-64230-1 665     | PAF8-05030100    | 3V1B01001-0 659    |
| PAF15-07040303   | 3R0-07238-0 659             | PAF8-04000021   | 3B2-65022-0 665     | PAF8-05030200    | 3V1-07235-0 659    |
| PAF15-07040304   | 3H8-07237-0 659             | PAF8-04000011   | 309-60111-0 665     | PAF8-05030300    | 3V1-07600-0 659    |
| PAF15-07080000   | 3AC-02230-0 644             | PAF8-04000200   | 3B2-65021-1 665     | PAF8-05030400    | 3H8-10062-2 659    |
| PAF15-07080000   | 3AD-02230-0 644             | PAF8-04000301   | 3V1-64211-0 663-665 | PAF8-05040000    | 3F5-03100-0 645    |
| PAF15-07080000   | 3B7-02230-0 644             | PAF8-04000302   | 3V1-64221-0 665     | PAF8-05040000    | 3V2-03100-2 645    |
| PAF4-01010002    | 398-62103-0 667             | PAF8-04000303   | 3B2-64215-0 663-665 | PAF8-05050002    | 3V1-05259-0 657    |
| PAF4-01010003    | 332-62101-0 667             | PAF8-04000305   | 369-64223-0 665     | PAF8-05050003    | 3R1-05125-0 657    |
| PAF4-01010005    | 3C8-62104-1 667             | PAF8-04010000   | 3B2-64010-0 663-665 | PAF8-05050004    | 3AA-05004-0 657    |
| PAF4-04000019    | 3T5-10131-0 659             | PAF8-04020001L  | 3V1-64307-1 663-665 | PAF8-05050005    | 3V1-05104-1 657    |
| PAF4-04130101    | 3AA-05019-0 657             | PAF8-04020001S  | 3V1-64306-1 663-665 | PAF8-05050006    | 3R1-05003-1 657    |
| PAF4-04130100    | 3R1-05131-0 657             | PAF8-04040000   | 3B2S60100-0 665     | PAF8-05050007    | 3R1-05012-0 657    |
| PAF4-05000300    | 346-02230-0 644             | PAF8-04040001   | 3B2S60101-0 665     | PAF8-05050009    | 3R1-05007-0 657    |
| PAF4-05000300    | 366-02230-0 644             | PAF8-04040002   | 345-65015-0 665     | PAF8-05050018    | 3AA-05013-0 657    |
| PAF4-05000300    | 366-02230-0 643             | PAF8-04040004   | 369-60111-0 665     | PAF8-05090000W   | 3V1-06023-0 647    |
| PAF8-00000002    | 3V1-61302-0 667             | PAF8-04050000   | 3B2W64517-0 665     | PAGB/T5783-M6X20 | 910184-5620 667    |
| PAF8-00000003    | 3R3-61017-0 659             | PAF8-05000002   | 3V1-01024-0 659     | PAGB/T5783-M8X30 | 910113-0830 667    |
| PAF8-00000004    | 3V1-01303-0 659             | PAF8-05000003   | 172-36008-0 657     | PAGB/T7940.1-M6  | 344-67177-0 667    |
| PAF8-00000100    | 3V1-61333-1 667             | PAF8-05000004   | 3V1-10045-0 643-659 | PAGB/T889.1-M8   | 3V1-61324-0 667    |
| PAF8-00000200    | 3V1-07421-0 659             | PAF8-05000006   | 3A0-76079-0 657     | PAGB/T896-5      | 945303-0500 667    |
| PAF8-05030010    | 3H8-07226-0 659             | PAF8-05000008   | 3V1-02010-1 659     | PAGB/T96-6       | 910184-5620 667    |
| PAF8-01000001    | 350-62423-0 667             | PAF8-05000009   | 3V1-02104-0 659     | PAJASOF40435-022 | 350-62415-0 667    |
| PAF8-01000002    | 350-62417-0 667             | PAF8-05000011   | 3T5-06920-0 657     | PANSKFJ-1516     | 3V1-60211-0 665    |
| PAF8-01000003    | 3V1-61313-0 667             | PAF8-05000012   | 3V1-06308-0 657     | PAT15-04000011   | 940121-1200 657    |
| PAF8-01000100    | 345-62441-0 667             | PAF8-05000013   | 3V1-06302-0 657     | PAT3.6-04000006  | 309-00131-0 659    |
| PAF8-01010102    | 346-62421-1 667             | PAF8-05000017   | 98AH10-0120 659     |                  |                    |
| PAF8-01010103    | 393-62437-0 667             | PAF8-05000018   | 346-67114-0 665     | <b>R</b>         |                    |
| PAF8-01010104    | 369-66112-1 667             | PAF8-05000019   | 3V1-63622-0 665     | REC06192-ZY3-000 | HZY3-06192-000 653 |
| PAF8-01010105    | 369-62439-1 667             | PAF8-05000020   | 3V1-63508-0 665     | REC06192-ZY6-000 | HZY6-06192-000 653 |
| PAF8-01010106    | 3V1-66313-0 667             | PAF8-05000021   | 3R0-66308-0 657     | REC06240-ZZ3-R30 | HZZ3-06240-R30 650 |
| PAF8-01010108    | 3B2-66321-1 667             | PAF8-05000024   | 369-00132-0 657     | REC06240-ZZ3-R40 | HZZ3-06240-R40 650 |
| PAF8-01010109    | 3B2-66315-0 667             | PAF8-05000025   | 98AB-5-0330 659     | REC15400-RBA-F01 | HPLM-15400-A0 645  |
| PAF8-01010112    | 3K9-05223-0 667             | PAF8-05000026   | 369-84398-0 659     | REC15400-RBA-F01 | HPLM-15400-PE 645  |
| PAF8-01010200    | 350-62121-1 667             | PAF8-05000100   | 3V1-02305-0 659     | REC16157         | 369-65011-0 653    |
| PAF8-01010200    | 369-62122-2 667             | PAF8-05000200   | 3V1-06071-0 647-657 | REC16159         | 369-65025-0 653    |
| PAF8-02000002    | 3B2-01215-0 667             | PAF8-05000300   | 3AA-06021-0 647-657 | REC16253         | 369-03231-0 646    |
| PAF8-02000003    | 3V1-07440-0 667             | PAF8-05000400   | 3AA-06060-0 657     | REC162532        | 3C8-03125-0 646    |
| PAF8-02000004    | 3V1-61220-0 667             | PAF8-05000400   | 3AA-06060-00 649    | REC16275         | 369-03303-0 644    |
| PAF8-02000005    | 3V1-61208-0 667             | PAF8-05000400   | 3AA060600M 649      | REC16325         | 369-03306-0 644    |
| PAF8-02000006(L) | 3V1-65110-0 667             | PAF8-05000500   | 3V1-06040-0 647-657 | REC16911-ZY3-010 | HZY3-16911-010 644 |
| PAF8-02000006(S) | 3V1-65100-0 667             | PAF8-05000500   | 3V1-06040-0 647     | REC16911-ZZ5-003 | HZZ5-16911-003 644 |
| PAF8-02000007    | 3V1-65206-0 667             | PAF8-05000600   | 3V1060400M 647      | REC19210-ZV5-003 | HZV5-19210-003 652 |
| PAF8-02000009    | 3V1-65203-0 667             | PAF8-05000800   | 3V1060400M 647      | REC19210-ZW1-B02 | HZW1-19210-B04 652 |
| PAF8-02000100    | 3V1-61301-1 940113-0800 667 | PAF8-05001000   | 3AA-06091-0 657     | REC19210-ZV3-003 | HZY3-19210-003 652 |
| PAF8-03000010    | 3V1-66211-0 665             | PAF8-05010000   | 3V1-07410-0 659     | REC19300-ZV5-043 | HZV5-19300-043 652 |
| PAF8-03000011    | 3V1-66302-0 665             | PAF8-05010002   | 3V1B01100-0 659     | REC26-16051      | 369-00122-0 654    |
| PAF8-03010001    | 3V1-66187-0 665             | PAF8-05010004   | 3H8-02093-0 659     | REC26-161301     | 346-60111-0 662    |
| PAF8-03010003    | 3V1-66225-0 665             | PAF8-05010005   | 3V1-02305-0 659     | REC26-16162      | 369-60223-0 662    |
| PAF8-03010005    | 3B2-66113-0 665             | PAF8-05010009   | 346-01032-0 659     | REC26-161622     | 346-65013-0 662    |
| PAF8-03010006    | 3C8-66116-0 665             | PAF8-05010009   | 3V1-07407-0 659     | REC26-16703      | 369-01215-0 662    |
| PAF8-03010007    | 3B1-66145-0 665             | PAF8-05010012   | 3V1-00121-0 659     | REC26-16703      | 101-00121-0 654    |
| PAF8-04000003    | 3B2-64020-0 663-665         | PAF8-05010014   | 3V1-10060-0 659     | REC26-803514     | 101-00121-0 654    |
| PAF8-04000004-1  | 3B2-64023-0 665             | PAF8-05010015   | 3V1-10063-0 659     | REC26-803667     | 350-00121-0 662    |
| PAF8-04000005    | 3B2-65020-0 665             | PAF8-05010016   | 3V1-10068-0 659     | REC26-85370711   | 3B2-00051-0 654    |
| PAF8-04000006    | 3B2-65029-0 665             | PAF8-05020001   | 3V1-10068-0 659     | REC26-8537072    | 346-01215-0 662    |
| PAF8-04000007    | 3B2-65025-0 653-665         | PAF8-05020101   | 3V1-00030-1 659     | REC27-16274      | 369-03302-0 644    |
| PAF8-04000008    | 3B2-65018-0 665             | PAF8-05020105   | 3V1-00001-0 659-662 | REC27-16326      | 369-03307-0 644    |
| PAF8-04000009    | 3B2-65016-0 665             | PAF8-05020105   | 332-00021-0 659     | REC27-8555691    | 3C8-04028-0 644    |
|                  |                             | PAF8-05020105   | 332-00024-0 662     | REC30-16049      | 9603-3-6204 654    |
|                  |                             | PAF8-05020200   | 3V1-00040-0 659-662 | REC30-160494     | 96603-3-6305 655   |
|                  |                             | PAF8-05030001   | 3V1-07201-0 659     | REC30-16049T01   | 345-00113-0 655    |
|                  |                             | PAF8-05030002   | 3V1-07202-0 659     | REC30-898101936  | 9643-3-6004 662    |

| REF                | OEM            |         |
|--------------------|----------------|---------|
| REC30-95307        | 9643-3-6202    | 662     |
| REC30580-ZV4-013   | HZV4-30580-013 | 647     |
| REC309-01005-2     | 309-01005-2    | 660     |
| REC31-16052        | 350-00042-0    | 654-661 |
| REC31-8036752      | 338-00042-0    | 654-661 |
| REC31-813048       | 369-00043-0    | 654     |
| REC31-8130482      | 356-00043-0    | 655     |
| REC31-855553       | 3C8-00113-0    | 656     |
| REC31200-ZY3-003   | HZY3-31200-003 | 648     |
| REC31200-ZY6-003   | HZY6-31200-003 | 648     |
| REC345-00042-0     | 345-00042-0    | 655-662 |
| REC345-65021-0     | 345-65021-0    | 652     |
| REC346-01005-0     | 346-01005-0    | 660     |
| REC346-01303-0     | 350-01303-0    | 660     |
| REC346-76010-0M    | 346-76010-0    | 648     |
| REC346-76010-0M    | 346-76010-0A0  | 648     |
| REC346-76010-0M    | 346-76010-0M   | 648     |
| REC35-80365M       |                | 644     |
| REC350-01005-0     | 350-01005-0    | 660     |
| REC350-01303-0     | 350-01303-0    | 660     |
| REC350-61012-1     | 350-61012-1    | 660     |
| REC351-01005-0     | 351-01005-0    | 660     |
| REC353-76010-4M    | 353-76010-4    | 648     |
| REC353760203       | 353760203      | 649     |
| REC35668-ZY6-003   | HZY6-35668-003 | 646     |
| REC369-06021-0     | 369-06021-0    | 647     |
| REC369-0682-0      | 369-0682-0     | 649     |
| REC37510-PNB-003   | HPNB-37510-003 | 646     |
| REC38100-87D10-OED |                | 649     |
| REC389-83880-1     | 389-83880-1    | 651     |
| REC39-16054A5      | 346-00011-0    | 655-661 |
| REC39-803678A1     | 350-00011-0    | 655     |
| REC39-803678A3     | 3B2-00011-0    | 654     |
| REC39-803678A3     | 3B2-00011-0    | 661     |
| REC39-8M0055809    | 3V1-00011-0    | 659     |
| REC3A0-06040-1     | 3A0-06040-1    | 647     |
| REC3A3068300       | 3A3068300      | 649     |
| REC3A3725600       | 3A3725600      | 648     |
| REC3ACQ843301      | 3ACQ843301     | 650     |
| REC3B2-01005-0     | 3B2-01005-0    | 660     |
| REC3B2-01303-0     | 3B2-01303-0    | 660     |
| REC3B2-65021-1     | 3B2-65021-1    | 652     |
| REC3B7-60217-0     | 3B7-60217-0M   | 652     |
| REC3B7-60217-OAL   | 3B7-60217-0    | 652     |
| REC3B7-65021-2     | 3B7-65021-2    | 652     |
| REC3C8-01005-4     | 3C8-01005-4    | 660     |
| REC3C8-01303-4     | 3C8-01303-4    | 660     |
| REC3C8-02305-0     | 3C8-02305-0    | 663     |
| REC3C8-65021-2     | 3C8-65021-2    | 652     |
| REC3F0-65029-0     | 3F0-65029-6    | 653     |
| REC3F3-00011-2     | 3F3-00011-2    | 662     |
| REC3F3-01303-1     | 3F3-01303-1    | 660     |
| REC3G2-06040-2     | 3G2-06040-2    | 647     |
| REC3G2-06060-2     | 3G2-06060-2    | 649     |
| REC3G3-06021-1     | 3G3-06021-1    | 647     |
| REC3GFQ845001      | 3GFQ845001     | 650     |
| REC3KY-76010-0     | 3KY-76010-0    | 648     |
| REC3KY-76010-0     | 3KY-76010-0M   | 648     |
| REC3KY-76010-0     | 3KY-76010-1    | 648     |
| REC3KY-76010-0     | 3KY-76010-1M   | 648     |
| REC3M2-60218-0     | 3M2-60218-0    | 652     |
| REC3M2-60218-OAL   | 3M2-60218-0    | 652     |
| REC40135           | 40135          | 644     |
| REC40145           | 40145          | 644     |
| REC40155           | 40155          | 644     |
| REC40165           | 40165          | 644     |
| REC41-16056        | 369-00021-0    | 654-661 |
| REC41-16056        | 3C8-00021-0    | 656     |
| REC41-803680002    | 350-00021-0    | 655-661 |

| REF                | OEM          |         |
|--------------------|--------------|---------|
| REC41-803680003    | 3C8-00021-0  | 655-661 |
| REC41-8036801      | 3B2-00021-0  | 654-661 |
| REC41-825713002    | 332-00021-0  | 655-661 |
| REC43-16138        |              | 663     |
| REC43-803739       |              | 663     |
| REC43-803739T03    |              | 663     |
| REC43-803740       |              | 663     |
| REC43-803740T02    |              | 663     |
| REC43-803741       |              | 663     |
| REC43-803741T03    |              | 663     |
| REC43-812944       |              | 663     |
| REC43-8129451      |              | 663     |
| REC44-195133       |              | 663     |
| REC45-161351       |              | 663     |
| REC45-803738       |              | 663     |
| REC45-8037381      |              | 663     |
| REC50-8M0147039    | 3C8-76010-1  | 648     |
| REC50-8M0147039    | 3C8760101    | 648     |
| REC50-8M0147039    | 3C8760101M   | 648     |
| REC53-16057        | 334-00024-1  | 655-662 |
| REC53-16057        | 350-00024-1  | 654-661 |
| REC5GH-13440-00    | 3R0-07615-0  | 645     |
| REC5GH-13440-00    | 3R3R76150M   | 645     |
| REC5GH-13440-00    | 5GH-13440-00 | 645     |
| REC5GH-13440-00    |              | 643     |
| REC629-803674      | 350-00040-0  | 655-661 |
| REC629-8036741     | 3B2-00040-0  | 654-662 |
| REC629-813047T01   | 336-00040-1  | 655-661 |
| REC66M-W0093-01    | 3V1-87122-0  | 645     |
| REC6G1-W0093-00    | 369-87122-1  | 645     |
| REC6G1-W0093-00    | 3B2-87122-0  | 645     |
| REC6H1-W0093-01-00 | 346-87122-0  | 645     |
| REC6H3-W0093-02    | 346-87122-0  | 645     |
| REC6H4-W0093-03    | 3F3-87122-1  | 645     |
| REC6L2-W0093-00    | 3C8-87122-2  | 646     |
| REC6L2-W0093-00    | 3G2-87122-2  | 646     |
| REC6L8-G3118-01    | 332S62102-1  | 667     |
| REC779-803677      | 350-00001-0  | 661     |
| REC779-803677      | 350-00001-1  | 655     |
| REC779-803677T02   | 351-00001-1  | 655-661 |
| REC779-804886      | 3B2-00001-0  | 654-661 |
| REC779-879194T01   | 346-00001-1  | 655-661 |
| REC779-96152       | 3C8-00001-3  | 662     |
| REC779-9615T       | 369-00001-0  | 654-661 |
| REC779-9615T       | 3C8-00001-3  | 656     |
| REC803673          | 350-00061-0  | 655     |
| REC803751          | 350-65011-1  | 653     |
| REC804898          | 3B2-63600-1  | 651     |
| REC813046002       | 369-00061-0  | 654     |
| REC8130461         | 334-00061-0  | 655     |
| REC84-819514T26    |              | 649     |
| REC8537312         | 350-04005-0  | 644     |
| REC855676002       | 3R3-01030-0  | 643-652 |
| REC879147T96       |              | 663     |
| REC8M0065585       | 350-01215-5  | 662     |
| REC8M0076368       |              | 663     |
| REC8M0080349       | 346-00011-0  | 656-662 |
| REC8M0080349       | 356-00011-0  | 662     |
| REC8M0080357       | 351-00011-0  | 654-661 |
| REC90340-08002     | 332-60005-2  | 665     |
| REC90430-08020     | 332-60006-0  | 665     |
| RECEU3849900       | EU3849900    | 651     |

## POLÍTICA DE GARANTÍA RECMAR

Todos los productos comercializados por **RECMAR** deben ser instalados y utilizados por personal competente bajo su exclusiva responsabilidad. **RECMAR** no se responsabiliza de las consecuencias producidas por una instalación defectuosa o inapropiada de ningún artículo que no incluya soluciones de instalación.

El instalador será el responsable de verificar la correcta aplicación de las recomendaciones del fabricante en cuanto a compatibilidades de uso.

Los artículos comercializados por **RECMAR** están amparados por la garantía legal.

**RECMAR** distribuye los artículos presentes en sus catálogos únicamente a profesionales, nunca a particulares o cliente final, el importe de la instalación jamás estará incluido en el precio por lo que no será responsable de ésta.

Los artículos comercializados por **RECMAR** disponen de una garantía limitada por defectos de fabricación, los periodos pueden variar entre los 3 años y los 3 meses, descartando los artículos considerados como consumibles: productos eléctricos, baterías y otros que carecen de periodo alguno, si necesita conocer el plazo exacto del producto contacte con el departamento comercial.

El material que enviamos diariamente desde **RECMAR** a nuestros clientes es examinado antes de empaquetarse para su perfecta integridad y evitar daños en el transporte. Recuerde que es muy importante inspeccionar las cargas en presencia del transportista. Cuando se observen daños en la caja, deberá incluirse en el albarán de entrega del transportista una mención del tipo (CONFORME MERCANCÍA, SALVO INSPECCIÓN), y deberá ser firmada por usted y el transportista. En caso de recibir material defectuoso por estas causas debe hacerlo constar tanto al transportista como a **RECMAR** para poder reclamar a la empresa de transporte correspondiente.

## SOLICITUD DE GARANTÍA

La garantía siempre estará sujeta a la valoración final del departamento técnico de **RECMAR**. Esta valoración se llevará a cabo en nuestras instalaciones o en caso necesario por el fabricante del artículo, en ambas opciones el artículo tiene que estar físicamente en nuestras instalaciones centrales de Viladecans. El tiempo para la resolución será un máximo de 30 días naturales desde su recepción.

Para enviar el artículo defectuoso, debe ir a la página web [www.recambiosmarinos.es](http://www.recambiosmarinos.es), o [www.usarecmar.com](http://www.usarecmar.com) ir a su cuenta y seleccionar TRAMITAR GARANTÍA dentro del área privada, desde aquí podrá descargar el archivo para la solicitud de garantías de motores y piezas, y seguir las instrucciones.

**RECMAR** no asumirá ningún préstamo de reemplazo durante el proceso de garantía.

## EXCLUSIONES DE GARANTÍA

**RECMAR** no podrá ser acusado como responsable del defecto ante:

- Desgaste normal del producto.
- Defectos de instalación o uso inadecuado.
- Instalación de un artículo no destinado a ese modelo.
- Daños por causa externa (accidente, rayo, fluctuación de corriente...)
- Defectos y consecuencias relacionadas con el transporte.
- Alteraciones en instalaciones o barcos destinados a la competición.

En caso de rechazo de la garantía, el cliente tiene la posibilidad de recuperar su artículo defectuoso poniéndose en contacto con nosotros vía e-mail solicitando la devolución del mismo dentro de los 7 días naturales siguientes a la fecha en que se le informó del rechazo de garantía.

**RECMAR** no forma parte de las garantías comerciales anunciadas en ocasiones por los fabricantes.

## RECMAR WARRANTY POLICY

All products sold by **RECMAR** must be installed and used by competent personnel under their exclusive responsibility. **RECMAR** shall not be responsible for the consequences of the faulty or improper installation of any item that does not include installation solutions.

The fitter will be responsible for checking that the manufacturer recommendations have been followed correctly in terms of compatible uses.

Articles sold by **RECMAR** are covered by legal warranty.

**RECMAR** distribute the products only to professionals and never to private final clients. The cost of installing the part would never be included in the price for which reason, **RECMAR** would never be responsible for its installation.

Articles sold by **RECMAR** are covered by warranty for manufacturing defects for a limited period of time that may vary between 3 years and 3 months, except for the articles considered consumable, electrical products, batteries and others that are not covered at all. For information on the exact warranty period of an article, please contact the Sales Department.

The goods that **RECMAR** sends every day to its customers are examined before being packed to ensure their perfect integrity and avoid damage during shipping. Remember that it is essential to check the goods in the presence of the dispatcher. If the package is damaged, the dispatcher's delivery note must mention what type (CONFORMING GOODS, UNLESS INSPECTED), and must be signed by you and by the dispatcher. If you receive damaged goods for these reasons you must notify both the dispatcher and **RECMAR** to be able to make the claim to the relevant delivery company.

## WARRANTY CLAIMS

Warranties are always subject to **RECMAR** Technical Department's assessment. The assessment will be carried out on **RECMAR**'s premises or, if necessary, by the article's manufacturer. In both cases, the article must be physically on **RECMAR**'s premises in Viladecans. Assessment time will not exceed 30 calendar days from receiving the article.

To return the faulty item, visit [www.recambiosmarinos.es](http://www.recambiosmarinos.es), or [www.usarecmar.com](http://www.usarecmar.com), go to your account and select PROCESS WARRANTY in the private section. From there you will be able to download the file to claim the warranty of engines and parts and follow the instructions.

**RECMAR** will not charge for the loan of the replacement during the warranty process.

## WARRANTY EXCLUSIONS

**RECMAR** shall not be responsible for product faults in the following cases:

- Normal wear and tear of a product.
- Installation faults or improper use.
- Installation of an article not designed for the model in question.
- Damage due to external causes (accidents, lightning, power surges...)
- Defects and consequences of transport.
- Alterations to installations or to boats intended for competitions.

If the warranty is refused, the customer may retrieve the faulty article by contacting **RECMAR** via email and requesting that the article is returned to them within 7 calendar days from the day the warranty was refused.

**RECMAR** does not apply the warranties offered from time to time by manufacturers.



**RECMAR**  
USA

1917 NW 79 Ave  
Miami, FL 33126

Ph. 786-962-5020

[info@usarecmar.com](mailto:info@usarecmar.com)

[www.usarecmar.com](http://www.usarecmar.com)

**RECMAR**<sup>®</sup>

Jocelyn Bell, 26  
08840 Viladecans  
Barcelona

phone: (+34) 93 662 66 55

[info@recambiosmarinos.es](mailto:info@recambiosmarinos.es)  
[www.recambiosmarinos.es](http://www.recambiosmarinos.es)

[www.recmar.es](http://www.recmar.es)